

FEATURES

High Precalibrated Accuracy: 0.5°C max @ +25°C
Excellent Linearity: 0.15°C max (0°C to +70°C)
Wide Operating Temperature Range: -25°C to +105°C
Single Supply Operation: +4 V to +30 V
Excellent Repeatability and Stability
High Level Output: 1 $\mu\text{A}/\text{K}$
**Two Terminal Monolithic IC: Temperature In/
Current Out**
Minimal Self-Heating Errors

PRODUCT DESCRIPTION

The AD592 is a two terminal monolithic integrated circuit temperature transducer that provides an output current proportional to absolute temperature. For a wide range of supply voltages the transducer acts as a high impedance temperature dependent current source of 1 $\mu\text{A}/\text{K}$. Improved design and laser wafer trimming of the IC's thin film resistors allows the AD592 to achieve absolute accuracy levels and nonlinearity errors previously unattainable at a comparable price.

The AD592 can be employed in applications between -25°C and +105°C where conventional temperature sensors (i.e., thermistor, RTD, thermocouple, diode) are currently being used. The inherent low cost of a monolithic integrated circuit in a plastic package, combined with a low total parts count in any given application, make the AD592 the most cost effective temperature transducer currently available. Expensive linearization circuitry, precision voltage references, bridge components, resistance measuring circuitry and cold junction compensation are not required with the AD592.

Typical application areas include: appliance temperature sensing, automotive temperature measurement and control, HVAC (heating/ventilating/air conditioning) system monitoring, industrial temperature control, thermocouple cold junction compensation, board-level electronics temperature diagnostics, temperature readout options in instrumentation, and temperature correction circuitry for precision electronics. Particularly useful in remote sensing applications, the AD592 is immune to voltage drops and voltage noise over long lines due to its high impedance current output. AD592s can easily be multiplexed; the signal current can be switched by a CMOS multiplexer or the supply voltage can be enabled with a tri-state logic gate.

The AD592 is available in three performance grades: the AD592AN, AD592BN and AD592CN. All devices are packaged in a plastic TO-92 case rated from -45°C to +125°C. Performance is specified from -25°C to +105°C. AD592 chips are also available, contact the factory for details.

REV. A

Information furnished by Analog Devices is believed to be accurate and reliable. However, no responsibility is assumed by Analog Devices for its use, nor for any infringements of patents or other rights of third parties which may result from its use. No license is granted by implication or otherwise under any patent or patent rights of Analog Devices.

CONNECTION DIAGRAM

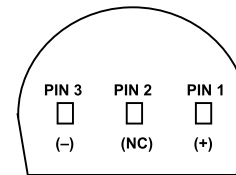

* PIN 2 CAN BE EITHER ATTACHED OR UNCONNECTED
BOTTOM VIEW

PRODUCT HIGHLIGHTS

1. With a single supply (4 V to 30 V) the AD592 offers 0.5°C temperature measurement accuracy.
2. A wide operating temperature range (-25°C to +105°C) and highly linear output make the AD592 an ideal substitute for older, more limited sensor technologies (i.e., thermistors, RTDs, diodes, thermocouples).
3. The AD592 is electrically rugged; supply irregularities and variations or reverse voltages up to 20 V will not damage the device.
4. Because the AD592 is a temperature dependent current source, it is immune to voltage noise pickup and IR drops in the signal leads when used remotely.
5. The high output impedance of the AD592 provides greater than 0.5°C/V rejection of supply voltage drift and ripple.
6. Laser wafer trimming and temperature testing insures that AD592 units are easily interchangeable.
7. Initial system accuracy will not degrade significantly over time. The AD592 has proven long term performance and repeatability advantages inherent in integrated circuit design and construction.

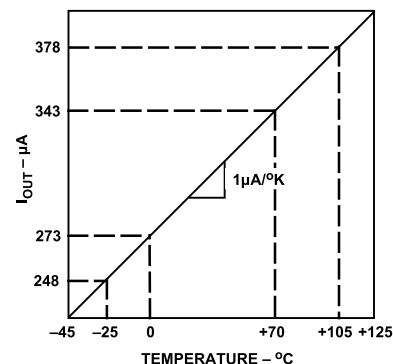

AD592—SPECIFICATIONS (typical @ $T_A = +25^\circ\text{C}$, $V_S = +5\text{ V}$, unless otherwise noted)

| Model | AD592AN | | | AD592BN | | | AD592CN | | | Units |
|--|---------|-------|------|---------|-------|------|---------|-------|------|-------------------------------|
| | Min | Typ | Max | Min | Typ | Max | Min | Typ | Max | |
| ACCURACY | | | | | | | | | | |
| Calibration Error @ $+25^\circ\text{C}$ ¹ $T_A = 0^\circ\text{C}$ to $+70^\circ\text{C}$ | | 1.5 | 2.5 | | 0.7 | 1.0 | | 0.3 | 0.5 | $^\circ\text{C}$ |
| Error over Temperature | | 1.8 | 3.0 | | 0.8 | 1.5 | | 0.4 | 0.8 | $^\circ\text{C}$ |
| Nonlinearity ² $T_A = -25^\circ\text{C}$ to $+105^\circ\text{C}$ | | 0.15 | 0.35 | | 0.1 | 0.25 | | 0.05 | 0.15 | $^\circ\text{C}$ |
| Error over Temperature ³ | | 2.0 | 3.5 | | 0.9 | 2.0 | | 0.5 | 1.0 | $^\circ\text{C}$ |
| Nonlinearity ² | | 0.25 | 0.5 | | 0.2 | 0.4 | | 0.1 | 0.35 | $^\circ\text{C}$ |
| OUTPUT CHARACTERISTICS | | | | | | | | | | |
| Nominal Current Output @ $+25^\circ\text{C}$ (298.2K) | | 298.2 | | | 298.2 | | | 298.2 | | μA |
| Temperature Coefficient | | 1 | | | 1 | | | 1 | | $\mu\text{A}/^\circ\text{C}$ |
| Repeatability ⁴ | | | 0.1 | | | 0.1 | | | 0.1 | $^\circ\text{C}$ |
| Long Term Stability ⁵ | | | 0.1 | | | 0.1 | | | 0.1 | $^\circ\text{C}/\text{month}$ |
| ABSOLUTE MAXIMUM RATINGS | | | | | | | | | | |
| Operating Temperature | -25 | | +105 | -25 | | +105 | -25 | | +105 | $^\circ\text{C}$ |
| Package Temperature ⁶ | -45 | | +125 | -45 | | +125 | -45 | | +125 | $^\circ\text{C}$ |
| Forward Voltage (+ to -) | | | 44 | | | 44 | | | 44 | V |
| Reverse Voltage (- to +) | | | 20 | | | 20 | | | 20 | V |
| Lead Temperature (Soldering 10 sec) | | | 300 | | | 300 | | | 300 | $^\circ\text{C}$ |
| POWER SUPPLY | | | | | | | | | | |
| Operating Voltage Range | 4 | | 30 | 4 | | 30 | 4 | | 30 | V |
| Power Supply Rejection | | | | | | | | | | |
| +4 V < V_S < +5 V | | | 0.5 | | | 0.5 | | | 0.5 | $^\circ\text{C}/\text{V}$ |
| +5 V < V_S < +15 V | | | 0.2 | | | 0.2 | | | 0.2 | $^\circ\text{C}/\text{V}$ |
| +15 V < V_S < +30 V | | | 0.1 | | | 0.1 | | | 0.1 | $^\circ\text{C}/\text{V}$ |

NOTES

¹An external calibration trim can be used to zero the error @ $+25^\circ\text{C}$.

²Defined as the maximum deviation from a mathematically best fit line.

³Parameter tested on all production units at $+105^\circ\text{C}$ only. C grade at -25°C also.

⁴Maximum deviation between $+25^\circ\text{C}$ readings after a temperature cycle between -45°C and $+125^\circ\text{C}$. Errors of this type are noncumulative.

⁵Operation @ $+125^\circ\text{C}$, error over time is noncumulative.

⁶Although performance is not specified beyond the operating temperature range, temperature excursions within the package temperature range will not damage the device. Specifications subject to change without notice.

Specifications shown in boldface are tested on all production units at final electrical test. Results from those tests are used to calculate outgoing quality levels. All min and max specifications are guaranteed, although only those shown in boldface are tested on all production units.

METALIZATION DIAGRAM

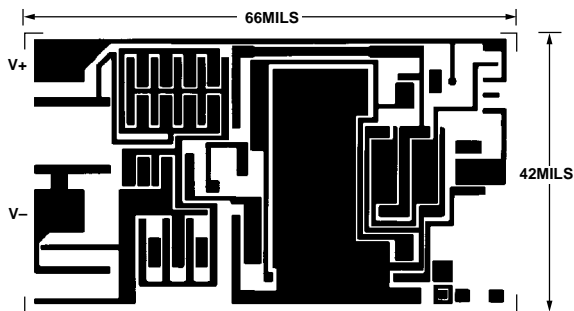

TEMPERATURE SCALE CONVERSION EQUATIONS

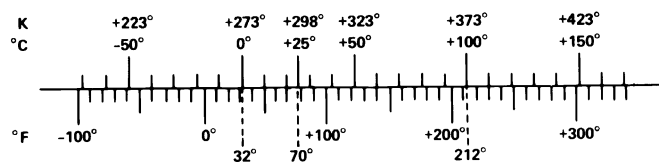

$$^\circ\text{C} = \frac{5}{9} (^\circ\text{F} - 32)$$

$$\text{K} = ^\circ\text{C} + 273.15$$

$$^\circ\text{F} = \frac{9}{5} ^\circ\text{C} + 32$$

$$^\circ\text{R} = ^\circ\text{F} + 459.7$$

ORDERING GUIDE

| Model | Max Cal Error @ $+25^\circ\text{C}$ | Max Error -25°C to $+105^\circ\text{C}$ | Max Nonlinearity -25°C to $+105^\circ\text{C}$ | Package Option |
|---------|-------------------------------------|---|--|----------------|
| AD592CN | 0.5 $^\circ\text{C}$ | 1.0 $^\circ\text{C}$ | 0.35 $^\circ\text{C}$ | TO-92 |
| AD592BN | 1.0 $^\circ\text{C}$ | 2.0 $^\circ\text{C}$ | 0.4 $^\circ\text{C}$ | TO-92 |
| AD592AN | 2.5 $^\circ\text{C}$ | 3.5 $^\circ\text{C}$ | 0.5 $^\circ\text{C}$ | TO-92 |

Typical Performance Curves—AD592

Typical @ $V_S = +5\text{ V}$

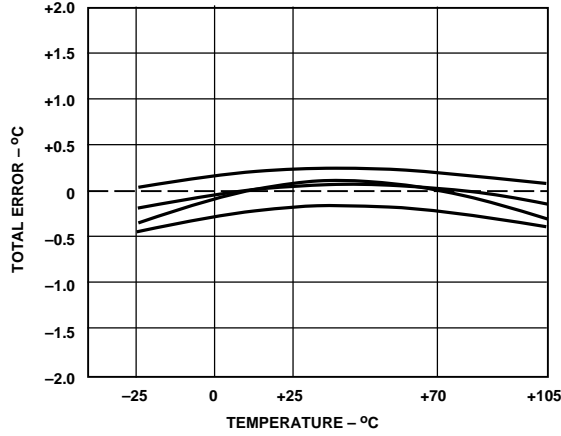

AD592CN Accuracy Over Temperature

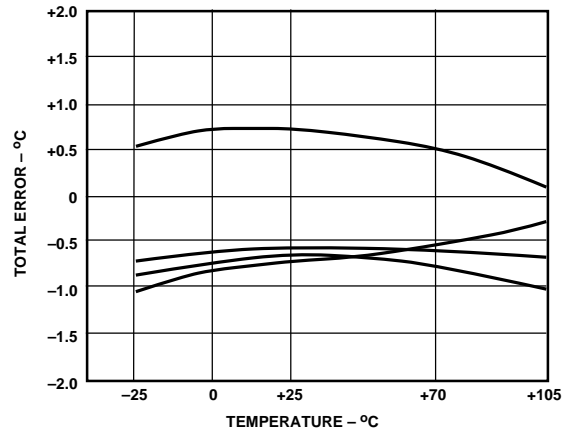

AD592BN Accuracy Over Temperature

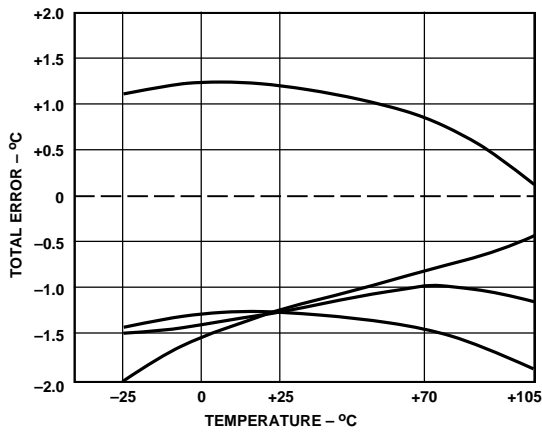

AD592AN Accuracy Over Temperature



Long-Term Stability @ +85°C and 85% Relative Humidity

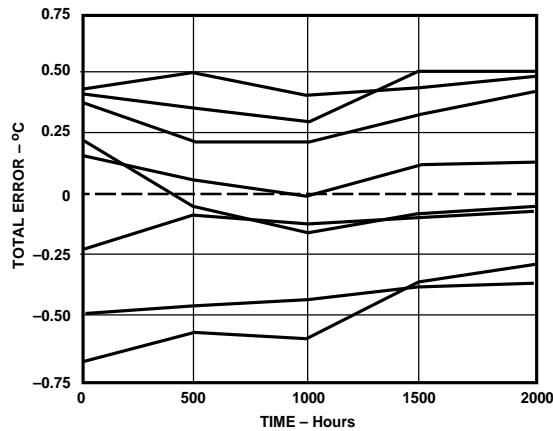

Long-Term Stability @ +125°C

AD592

THEORY OF OPERATION

The AD592 uses a fundamental property of silicon transistors to realize its temperature proportional output. If two identical transistors are operated at a constant ratio of collector current densities, r , then the difference in base-emitter voltages will be $(kT/q)(\ln r)$. Since both k , Boltzman's constant and q , the charge of an electron are constant, the resulting voltage is directly Proportional To Absolute Temperature (PTAT). In the AD592 this difference voltage is converted to a PTAT current by low temperature coefficient thin film resistors. This PTAT current is then used to force the total output current to be proportional to degrees Kelvin. The result is a current source with an output equal to a scale factor times the temperature (K) of the sensor. A typical V-I plot of the circuit at +25°C and the temperature extremes is shown in Figure 1.

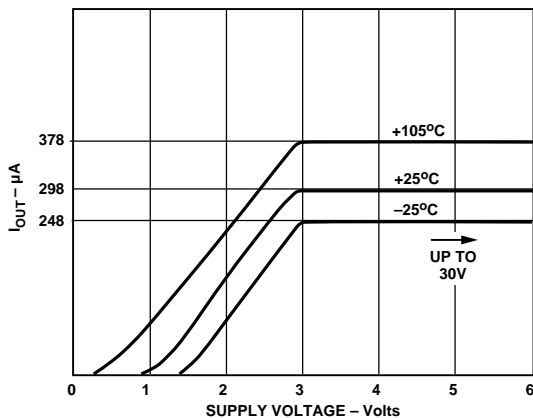

Figure 1. V-I Characteristics

Factory trimming of the scale factor to 1 $\mu\text{A}/\text{K}$ is accomplished at the wafer level by adjusting the AD592's temperature reading so it corresponds to the actual temperature. During laser trimming the IC is at a temperature within a few degrees of 25°C and is powered by a 5 V supply. The device is then packaged and automatically temperature tested to specification.

FACTORS AFFECTING AD592 SYSTEM PRECISION

The accuracy limits given on the Specifications page for the AD592 make it easy to apply in a variety of diverse applications. To calculate a total error budget in a given system it is important to correctly interpret the accuracy specifications, non-linearity errors, the response of the circuit to supply voltage variations and the effect of the surrounding thermal environment. As with other electronic designs external component selection will have a major effect on accuracy.

CALIBRATION ERROR, ABSOLUTE ACCURACY AND NONLINEARITY SPECIFICATIONS

Three primary limits of error are given for the AD592 such that the correct grade for any given application can easily be chosen for the overall level of accuracy required. They are the calibration accuracy at +25°C, and the error over temperature from 0°C to +70°C and -25°C to +105°C. These specifications correspond to the actual error the user would see if the current output of an AD592 were converted to a voltage with a precision

resistor. Note that the maximum error at room temperature, over the commercial IC temperature range, or an extended range including the boiling point of water, can be directly read from the specifications table. All three error limits are a combination of initial error, scale factor variation and nonlinearity deviation from the ideal 1 $\mu\text{A}/\text{K}$ output. Figure 2 graphically depicts the guaranteed limits of accuracy for an AD592CN.



Figure 2. Error Specifications (AD592CN)

The AD592 has a highly linear output in comparison to older technology sensors (i.e., thermistors, RTDs and thermocouples), thus a nonlinearity error specification is separated from the absolute accuracy given over temperature. As a maximum deviation from a best-fit straight line this specification represents the only error which cannot be trimmed out. Figure 3 is a plot of typical AD592CN nonlinearity over the full rated temperature range.



Figure 3. Nonlinearity Error (AD592CN)

TRIMMING FOR HIGHER ACCURACY

Calibration error at 25°C can be removed with a single temperature trim. Figure 4 shows how to adjust the AD592's scale factor in the basic voltage output circuit.

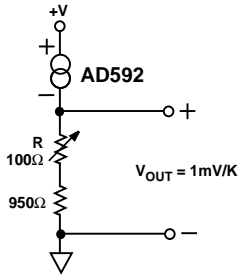

Figure 4. Basic Voltage Output (Single Temperature Trim)

To trim the circuit the temperature must be measured by a reference sensor and the value of R should be adjusted so the output (V_{OUT}) corresponds to 1 mV/K. Note that the trim procedure should be implemented as close as possible to the temperature highest accuracy is desired for. In most applications if a single temperature trim is desired it can be implemented where the AD592 current-to-output voltage conversion takes place (e.g., output resistor, offset to an op amp). Figure 5 illustrates the effect on total error when using this technique.

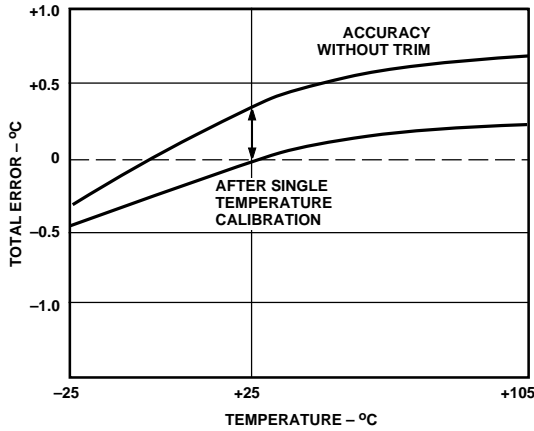

Figure 5. Effect of Scale Factor Trim on Accuracy

If greater accuracy is desired, initial calibration and scale factor errors can be removed by using the AD592 in the circuit of Figure 6.

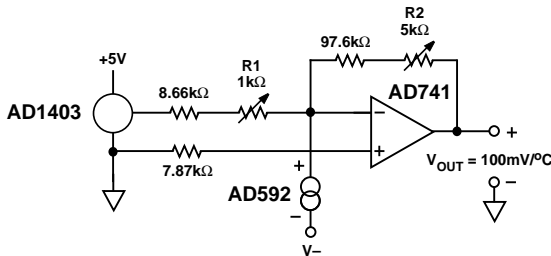

Figure 6. Two Temperature Trim Circuit

With the transducer at 0°C adjustment of R1 for a 0 V output nulls the initial calibration error and shifts the output from K to °C. Tweaking the gain of the circuit at an elevated temperature by adjusting R2 trims out scale factor error. The only error remaining over the temperature range being trimmed for is nonlinearity. A typical plot of two trim accuracy is given in Figure 7.

SUPPLY VOLTAGE AND THERMAL ENVIRONMENT EFFECTS

The power supply rejection characteristics of the AD592 minimizes errors due to voltage irregularity, ripple and noise. If a supply is used other than 5 V (used in factory trimming), the power supply error can be removed with a single temperature trim. The PTAT nature of the AD592 will remain unchanged. The general insensitivity of the output allows the use of lower cost unregulated supplies and means that a series resistance of several hundred ohms (e.g., CMOS multiplexer, meter coil resistance) will not degrade the overall performance.

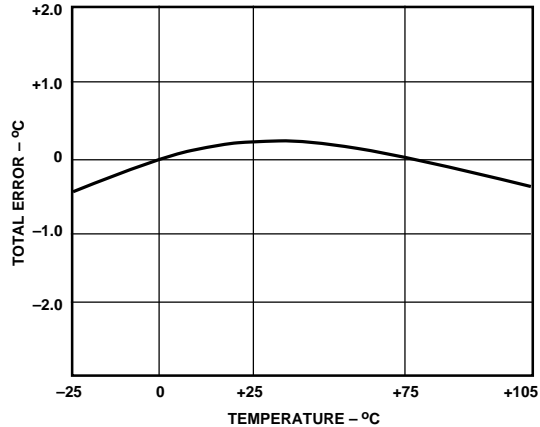

Figure 7. Typical Two Trim Accuracy

The thermal environment in which the AD592 is used determines two performance traits: the effect of self-heating on accuracy and the response time of the sensor to rapid changes in temperature. In the first case, a rise in the IC junction temperature above the ambient temperature is a function of two variables; the power consumption level of the circuit and the thermal resistance between the chip and the ambient environment (θ_{JA}). Self-heating error in °C can be derived by multiplying the power dissipation by θ_{JA} . Because errors of this type can vary widely for surroundings with different heat sinking capacities it is necessary to specify θ_{JA} under several conditions. Table I shows how the magnitude of self-heating error varies relative to the environment. In typical free air applications at +25°C with a 5 V supply the magnitude of the error is 0.2°C or less. A common clip-on heat sink will reduce the error by 25% or more in critical high temperature, large supply voltage situations.

Table I. Thermal Characteristics

| Medium | θ_{JA} (°C/watt) | τ (sec)* |
|-------------------|-------------------------|---------------|
| Still Air | | |
| Without Heat Sink | 175 | 60 |
| With Heat Sink | 130 | 55 |
| Moving Air | | |
| Without Heat Sink | 60 | 12 |
| With Heat Sink | 40 | 10 |
| Fluorinert Liquid | 35 | 5 |
| Aluminum Block** | 30 | 2.4 |

NOTES

* τ is an average of five time constants (99.3% of final value). In cases where the thermal response is not a simple exponential function, the actual thermal response may be better than indicated.

**With thermal grease.

AD592

Response of the AD592 output to abrupt changes in ambient temperature can be modeled by a single time constant τ exponential function. Figure 8 shows typical response time plots for several media of interest.



Figure 8. Thermal Response Curves

The time constant, τ , is dependent on θ_{JA} and the thermal capacities of the chip and the package. Table I lists the effective τ (time to reach 63.2% of the final value) for several different media. Copper printed circuit board connections where neglected in the analysis, however, they will sink or conduct heat directly through the AD592's solder dipped Kovar leads. When faster response is required a thermally conductive grease or glue between the AD592 and the surface temperature being measured should be used. In free air applications a clip-on heat sink will decrease output stabilization time by 10-20%.

MOUNTING CONSIDERATIONS

If the AD592 is thermally attached and properly protected, it can be used in any temperature measuring situation where the maximum range of temperatures encountered is between -25°C and $+105^{\circ}\text{C}$. Because plastic IC packaging technology is employed, excessive mechanical stress must be safeguarded against when fastening the device with a clamp or screw-on heat tab. Thermally conductive epoxy or glue is recommended under typical mounting conditions. In wet or corrosive environments, any electrically isolated metal or ceramic well can be used to shield the AD592. Condensation at cold temperatures can cause leakage current related errors and should be avoided by sealing the device in nonconductive epoxy paint or dips.

APPLICATIONS

Connecting several AD592 devices in parallel adds the currents through them and produces a reading proportional to the average temperature. Series AD592s will indicate the lowest temperature because the coldest device limits the series current flowing through the sensors. Both of these circuits are depicted in Figure 9.



Figure 9. Average and Minimum Temperature Connections

The circuit of Figure 10 demonstrates a method in which a voltage output can be derived in a differential temperature measurement.

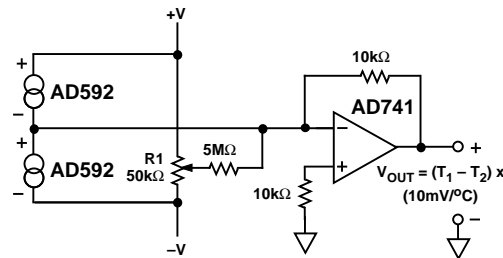

Figure 10. Differential Measurements

R1 can be used to trim out the inherent offset between the two devices. By increasing the gain resistor (10 k Ω) temperature measurements can be made with higher resolution. If the magnitude of V+ and V- is not the same, the difference in power consumption between the two devices can cause a differential self-heating error.

Cold junction compensation (CJC) used in thermocouple signal conditioning can be implemented using an AD592 in the circuit configuration of Figure 11. Expensive simulated ice baths or hard to trim, inaccurate bridge circuits are no longer required.



Figure 11. Thermocouple Cold Junction Compensation

The circuit shown can be optimized for any ambient temperature range or thermocouple type by simply selecting the correct value for the scaling resistor – R. The AD592 output ($1 \mu\text{A/K}$) times R should approximate the line best fit to the thermocouple curve (slope in $\text{V}/^\circ\text{C}$) over the most likely ambient temperature range. Additionally, the output sensitivity can be chosen by selecting the resistors R_{G1} and R_{G2} for the desired noninverting gain. The offset adjustment shown simply references the AD592 to $^\circ\text{C}$. Note that the TC's of the reference and the resistors are the primary contributors to error. Temperature rejection of 40 to 1 can be easily achieved using the above technique.

Although the AD592 offers a noise immune current output, it is not compatible with process control/industrial automation current loop standards. Figure 12 is an example of a temperature to 4–20 mA transmitter for use with 40 V, 1 k Ω systems.

In this circuit the $1 \mu\text{A/K}$ output of the AD592 is amplified to $1 \text{ mA}/^\circ\text{C}$ and offset so that 4 mA is equivalent to 17°C and 20 mA is equivalent to 33°C . R_t is trimmed for proper reading at an intermediate reference temperature. With a suitable choice of resistors, any temperature range within the operating limits of the AD592 may be chosen.



Figure 12. Temperature to 4–20 mA Current Transmitter

Reading temperature with an AD592 in a microprocessor based system can be implemented with the circuit shown in Figure 13.



Figure 13. Temperature to Digital Output

By using a differential input A/D converter and choosing the current to voltage conversion resistor correctly, any range of temperatures (up to the 130°C span the AD592 is rated for) centered at any point can be measured using a minimal number of components. In this configuration the system will resolve up to 1°C .

A variable temperature controlling thermostat can easily be built using the AD592 in the circuit of Figure 14.

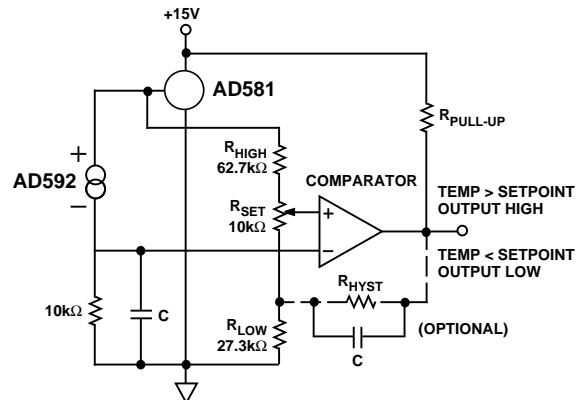

Figure 14. Variable Temperature Thermostat

R_{HIGH} and R_{LOW} determine the limits of temperature controlled by the potentiometer R_{SET} . The circuit shown operates over the full temperature range (-25°C to $+105^\circ\text{C}$) the AD592 is rated for. The reference maintains a constant set point voltage and insures that approximately 7 V appears across the sensor. If it is necessary to guardband for extraneous noise hysteresis can be added by tying a resistor from the output to the ungrounded end of R_{LOW} .

Multiple remote temperatures can be measured using several AD592s with a CMOS multiplexer or a series of 5 V logic gates because of the device's current-mode output and supply-voltage compliance range. The on-resistance of a FET switch or output impedance of a gate will not affect the accuracy, as long as 4 V is maintained across the transducer. MUXs and logic driving circuits should be chosen to minimize leakage current related errors. Figure 15 illustrates a locally controlled MUX switching the signal current from several remote AD592s. CMOS or TTL gates can also be used to switch the AD592 supply voltages, with the multiplexed signal being transmitted over a single twisted pair to the load.



Figure 15. Remote Temperature Multiplexing

AD592

To minimize the number of MUXs required when a large number of AD592s are being used, the circuit can be configured in a matrix. That is, a decoder can be used to switch the supply voltage to a column of AD592s while a MUX is used to control which row of sensors are being measured. The maximum number of AD592s which can be used is the product of the number of channels of the decoder and MUX.

An example circuit controlling 80 AD592s is shown in Figure 16. A 7-bit digital word is all that is required to select one of the sensors. The enable input of the multiplexer turns all the sensors off for minimum dissipation while idling.

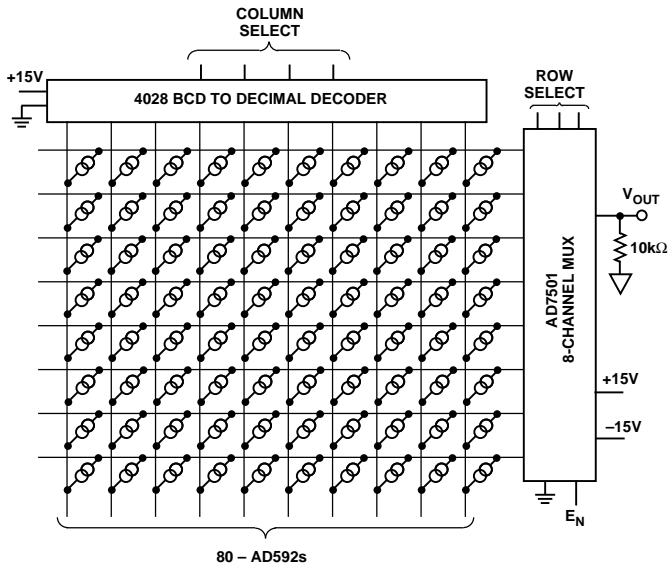

Figure 16. Matrix Multiplexer

To convert the AD592 output to °C or °F a single inexpensive reference and op amp can be used as shown in Figure 17. Although this circuit is similar to the two temperature trim circuit shown in Figure 6, two important differences exist. First, the gain resistor is fixed alleviating the need for an elevated temperature trim. Acceptable accuracy can be achieved by choosing an inexpensive resistor with the correct tolerance. Second, the AD592 calibration error can be trimmed out at a known convenient temperature (i.e., room temperature) with a single pot adjustment. This step is independent of the gain selection.

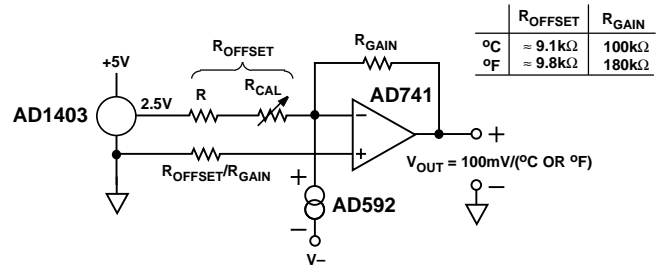

Figure 17. Celsius or Fahrenheit Thermometer

OUTLINE DIMENSIONS

Dimensions shown in inches and (mm).

