

SN74LVC244A Octal Buffer or Driver With 3-State Outputs

1 Features

- Operates From 1.65 V to 3.6 V
- Inputs Accept Voltages to 5.5 V
- Specified From -40°C to $+85^{\circ}\text{C}$ and -40°C to $+125^{\circ}\text{C}$
- Maximum t_{pd} of 5.9 ns at 3.3 V
- Typical V_{OLP} (Output Ground Bounce) < 0.8 V at $V_{CC} = 3.3$ V, $T_A = 25^{\circ}\text{C}$
- Typical V_{OHV} (Output V_{OH} Undershoot) > 2 V at $V_{CC} = 3.3$ V, $T_A = 25^{\circ}\text{C}$
- Supports Mixed-Mode Signal Operation on All Ports (5-V Input or Output Voltage With 3.3-V V_{CC})
- I_{off} Supports Live Insertion, Partial-Power-Down Mode, and Back-Drive Protection
- Can Be Used as a Down Translator to Translate Inputs From a Maximum of 5.5 V Down to the V_{CC} Level
- Available in Ultra Small Logic QFN Package (0.5 mm Maximum Height)
- Latch-Up Performance Exceeds 250 mA Per JESD 17
- ESD Protection Exceeds JESD 22
 - 2000-V Human-Body Model
 - 1000-V Charged-Device Model

2 Applications

- Servers
- LED Displays
- Network Switches
- Telecom Infrastructure
- Motor Drivers
- I/O Expanders

3 Description

These octal bus buffers are designed for 1.65-V to 3.6-V V_{CC} operation. The SN74LVC244A devices are designed for asynchronous communication between data buses.

Device Information

PART NUMBER	PACKAGE	BODY SIZE (NOM)
SN74LVC244AN	PDIP (20)	25.40 mm × 6.35 mm
SN74LVC244ANS	SO (20)	12.60 mm × 5.30 mm
SN74LVC244ADB	SSOP (20)	7.50 mm × 5.30 mm
SN74LVC244ADGV	TVSOP (20)	5.00 mm × 4.40 mm
SN74LVC244ADW	SOIC (20)	12.80 mm × 7.50 mm
SN74LVC244ARGY	VQFN (20)	4.50 mm × 3.50 mm
SN74LVC244AZQN	BGA (20)	3.00 mm × 4.00 mm
SN74LVC244APW	TSSOP (20)	6.50 mm × 4.40 mm
SN74LVC244ARWP	X1QFN (20)	2.50 mm × 3.30 mm

(1) For all available packages, see the orderable addendum at the end of the data sheet.

Logic Diagram (Positive Logic)

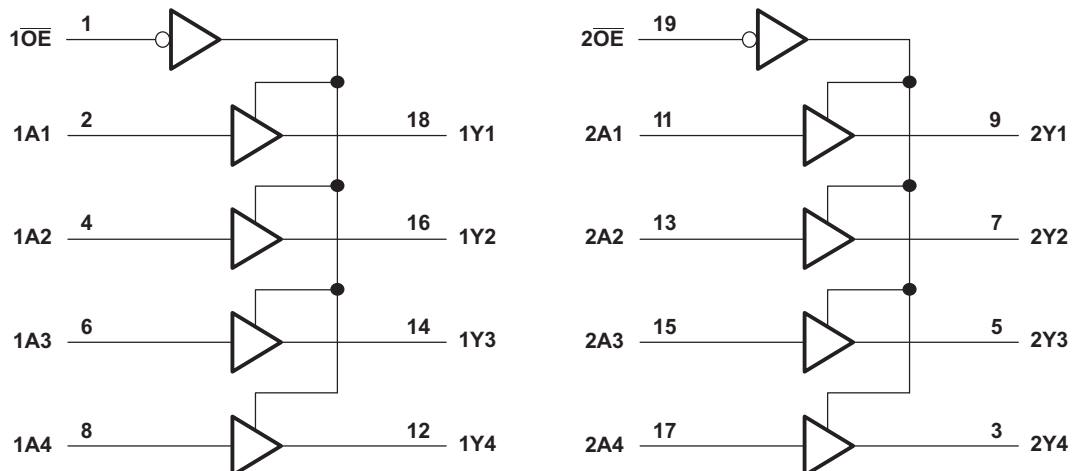

Pin numbers shown are for the DB, DGV, DW, N, NS, PW, and RGY packages.



Table of Contents

1 Features	1	8.2 Functional Block Diagram	9
2 Applications	1	8.3 Feature Description	9
3 Description	1	8.4 Device Functional Modes	9
4 Revision History	2	9 Application and Implementation	10
5 Pin Configuration and Functions	3	9.1 Application Information	10
6 Specifications	4	9.2 Typical Application	10
6.1 Absolute Maximum Ratings	4	10 Power Supply Recommendations	11
6.2 ESD Ratings	5	11 Layout	11
6.3 Recommended Operating Conditions	5	11.1 Layout Guidelines	11
6.4 Thermal Information	5	11.2 Layout Example	11
6.5 Electrical Characteristics	6	12 Device and Documentation Support	12
6.6 Switching Characteristics	6	12.1 Receiving Notification of Documentation Updates	12
6.7 Operating Characteristics	7	12.2 Community Resources	12
6.8 Typical Characteristics	7	12.3 Trademarks	12
7 Parameter Measurement Information	8	12.4 Electrostatic Discharge Caution	12
8 Detailed Description	9	12.5 Glossary	12
8.1 Overview	9	13 Mechanical, Packaging, and Orderable Information	12

4 Revision History

NOTE: Page numbers for previous revisions may differ from page numbers in the current version.

Changes from Revision AA (June 2016) to Revision AB	Page
• Changed A2 to A4 for $\overline{2OE}$ in <i>Pin Functions</i> table	4
• Added ambient temperature, T_A for BGA package and all other packages in <i>Recommended Operating Conditions</i>	5
• Added <i>Receiving Notification of Documentation Updates</i> section	12

Changes from Revision Z (January 2015) to Revision AA	Page
• Updated <i>Device Information</i> table to show all available packages	1
• Added RWP Package	3
• Deleted GQN package from <i>Pin Functions</i> table	4
• Added RWP thermal information to <i>Thermal Information</i> table and updated all thermal information for existing packages	5
• Updated all values for ZQN column in <i>Thermal Information</i> table	5
• Added package type in <i>Thermal Information</i> table	5
• Added RWP thermal information to <i>Thermal Information</i> table and updated all thermal information for existing packages	6
• Updated all values for ZQN column in <i>Thermal Information</i> table	6
• Added package type in <i>Thermal Information</i> table	6

Changes from Revision Y (September 2010) to Revision Z	Page
• Added <i>Applications</i> , <i>Device Information</i> table, <i>Pin Functions</i> table, <i>ESD Ratings</i> table, <i>Thermal Information</i> table, <i>Typical Characteristics</i> , <i>Feature Description</i> section, <i>Device Functional Modes</i> , <i>Application and Implementation</i> section, <i>Power Supply Recommendations</i> section, <i>Layout</i> section, <i>Device and Documentation Support</i> section, and <i>Mechanical, Packaging, and Orderable Information</i> section	1
• Deleted <i>Ordering Information</i> table, see <i>Mechanical, Packaging, and Orderable Information</i> at the end of the datasheet ..	1
• Updated <i>Features</i>	1

5 Pin Configuration and Functions

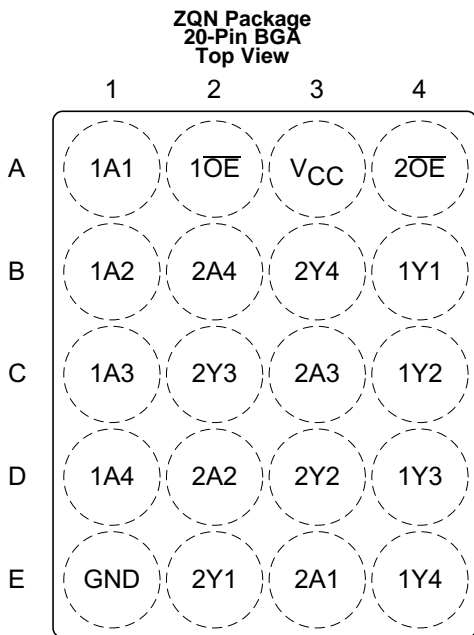

Not to scale

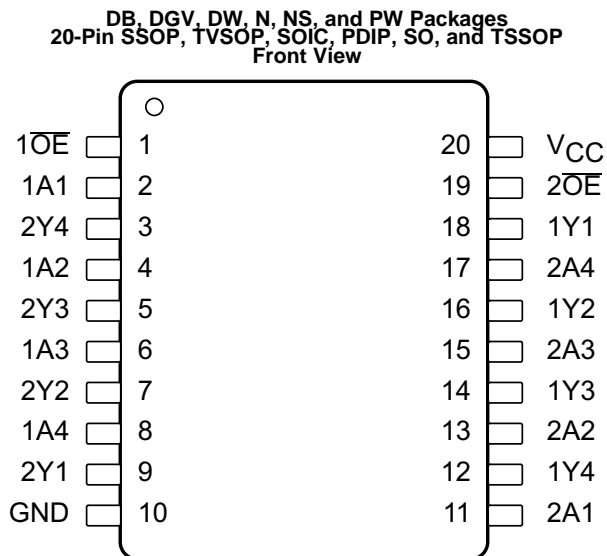

Not to scale

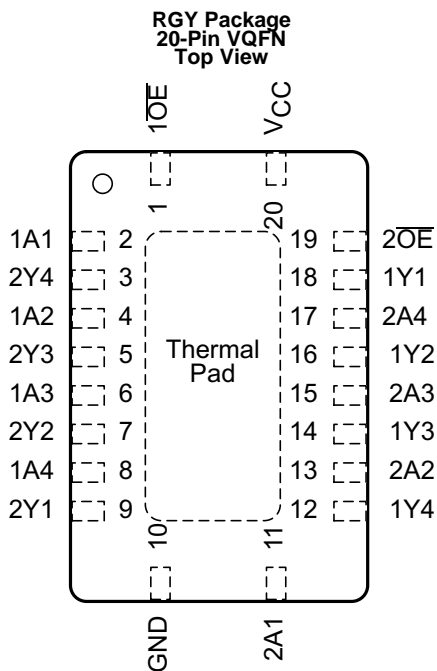

Not to scale

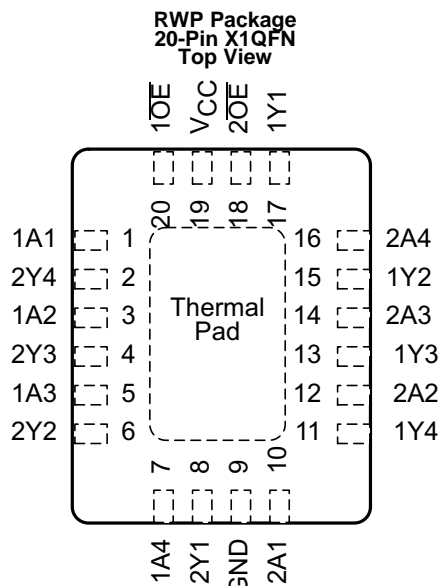

Not to scale

TI recommends to connect the exposed thermal pad to ground for best thermal performance. Must not be connected to any other pin than ground.

Pin Functions

NAME	PIN			TYPE	DESCRIPTION
	DB, DGV, DW, N, NS, PW, and RGY	ZQN	RWP		
1A1	2	A1	1	I	Port 1 A1 input
1A2	4	B1	3	I	Port 1 A2 input
1A3	6	C1	5	I	Port 1 A3 input
1A4	8	D1	7	I	Port 1 A4 input
$\overline{1OE}$	1	A2	20	I	Output enable
1Y1	18	B4	17	O	Port 1 Y1 output
1Y2	16	C4	15	O	Port 1 Y2 output
1Y3	14	D4	13	O	Port 1 Y3 output
1Y4	12	E4	11	O	Port 1 Y4 output
2A1	11	E3	10	I	Port 2 A1 input
2A2	13	D2	12	I	Port 2 A2 input
2A3	15	C3	14	I	Port 2 A3 input
2A4	17	B2	16	I	Port 2 A4 input
$2\overline{OE}$	19	A4	18	I	Output enable
2Y1	9	E2	8	O	Port 2 Y1 output
2Y2	7	D3	6	O	Port 2 Y2 output
2Y3	5	C2	4	O	Port 2 Y3 output
2Y4	3	B3	2	O	Port 2 Y4 output
GND	10	E1	9	—	Ground
V _{CC}	20	A3	19	—	Power pin

6 Specifications

6.1 Absolute Maximum Ratings

over operating free-air temperature range (unless otherwise noted)⁽¹⁾

		MIN	MAX	UNIT
V _{CC}	Supply voltage	−0.5	6.5	V
V _I	Input voltage ⁽²⁾	−0.5	6.5	V
V _O	Voltage range applied to any output in the high-impedance or power-off state ⁽²⁾	−0.5	6.5	V
V _O	Voltage range applied to any output in the high or low state ⁽²⁾⁽³⁾	−0.5	V _{CC} + 0.5	V
I _{IK}	Input clamp current	V _I < 0		−50 mA
I _{OK}	Output clamp current	V _O < 0		−50 mA
I _O	Continuous output current			±50 mA
	Continuous current through V _{CC} or GND			±100 mA
P _{tot}	Power dissipation	T _A = −40°C to +125°C ⁽⁴⁾⁽⁵⁾		500 mW
T _J	Junction temperature			150 °C
T _{stg}	Storage temperature	−65	150	°C

- (1) Stresses beyond those listed under *Absolute Maximum Ratings* may cause permanent damage to the device. These are stress ratings only, and functional operation of the device at these or any other conditions beyond those indicated under *Recommended Operating Conditions* is not implied. Exposure to absolute-maximum-rated conditions for extended periods may affect device reliability.
- (2) The input and output negative-voltage ratings may be exceeded if the input and output current ratings are observed.
- (3) The value of V_{CC} is provided in the *Recommended Operating Conditions* table.
- (4) For the DW package: above 70°C the value of P_{tot} derates linearly with 8 mW/K.
- (5) For the DB, DGV, N, NS, and PW packages: above 60°C the value of P_{tot} derates linearly with 5.5 mW/K.

6.2 ESD Ratings

		VALUE	UNIT
$V_{(ESD)}$ Electrostatic discharge	Human-body model (HBM), per ANSI/ESDA/JEDEC JS-001 ⁽¹⁾	±2000	V
	Charged-device model (CDM), per JEDEC specification JESD22-C101 ⁽²⁾	±1000	

(1) JEDEC document JEP155 states that 500-V HBM allows safe manufacturing with a standard ESD control process.

(2) JEDEC document JEP157 states that 250-V CDM allows safe manufacturing with a standard ESD control process.

6.3 Recommended Operating Conditions

over recommended operating free-air temperature range (unless otherwise noted)⁽¹⁾

		$T_A = 25^\circ\text{C}$		$-40 \text{ TO } +85^\circ\text{C}$		$-40 \text{ TO } +125^\circ\text{C}$		UNIT
		MIN	MAX	MIN	MAX	MIN	MAX	
V_{CC} Supply voltage	Operating	1.65	3.6	1.65	3.6	1.65	3.6	V
	Data retention only	1.5		1.5		1.5		
V_{IH} High-level input voltage	$V_{CC} = 1.65 \text{ V to } 1.95 \text{ V}$	$0.65 \times V_{CC}$		$0.65 \times V_{CC}$		$0.65 \times V_{CC}$		V
	$V_{CC} = 2.3 \text{ V to } 2.7 \text{ V}$	1.7		1.7		1.7		
	$V_{CC} = 2.7 \text{ V to } 3.6 \text{ V}$	2		2		2		
V_{IL} Low-level input voltage	$V_{CC} = 1.65 \text{ V to } 1.95 \text{ V}$	$0.35 \times V_{CC}$		$0.35 \times V_{CC}$		$0.35 \times V_{CC}$		V
	$V_{CC} = 2.3 \text{ V to } 2.7 \text{ V}$	0.7		0.7		0.7		
	$V_{CC} = 2.7 \text{ V to } 3.6 \text{ V}$	0.8		0.8		0.8		
V_I Input voltage		0	5.5	0	5.5	0	5.5	V
V_O Output voltage		0	V_{CC}	0	V_{CC}	0	V_{CC}	V
I_{OH} High-level output current	$V_{CC} = 1.65 \text{ V}$	–4		–4		–4		mA
	$V_{CC} = 2.3 \text{ V}$	–8		–8		–8		
	$V_{CC} = 2.7 \text{ V}$	–12		–12		–12		
	$V_{CC} = 3 \text{ V}$	–24		–24		–24		
I_{OL} Low-level output current	$V_{CC} = 1.65 \text{ V}$	4		4		4		mA
	$V_{CC} = 2.3 \text{ V}$	8		8		8		
	$V_{CC} = 2.7 \text{ V}$	12		12		12		
	$V_{CC} = 3 \text{ V}$	24		24		24		
T_A Ambient temperature	BGA package			–40	85			°C
	All other packages					–40	125	

(1) All unused inputs of the device must be held at V_{CC} or GND to ensure proper device operation. See [Implications of Slow or Floating CMOS Inputs](#), SCBA004.

6.4 Thermal Information

THERMAL METRIC ⁽¹⁾	SN74LVC244A										UNIT
	DB ⁽²⁾ (SSOP)	DGV ⁽²⁾ (TVSOP)	DW ⁽²⁾ (SOIC)	ZQN ⁽²⁾ (BGA)	N ⁽²⁾ (PDIP)	NS ⁽²⁾ (SO)	PW ⁽²⁾ (TSSOP)	RGY ⁽³⁾ (VQFN)	RWP ⁽³⁾ (X1QFN)		
	20 PINS										
$R_{\theta JA}$ Junction-to-ambient thermal resistance	108.1	128.7	90.9	198.7	61.6	90.1	114.7	50.3	79.9		°C/W
$R_{\theta JC(top)}$ Junction-to-case (top) thermal resistance	70.2	43.7	55.3	106.8	46.5	56.4	48.4	58.4	63.2		°C/W
$R_{\theta JB}$ Junction-to-board thermal resistance	63.3	70.2	58.8	143.1	42.5	57.7	65.6	28.3	46.4		°C/W
ψ_{JT} Junction-to-top characterization parameter	30.6	3.1	29.1	24.1	34.6	28.4	6.8	4.9	2.6		°C/W
ψ_{JB} Junction-to-board characterization parameter	62.9	69.5	58.3	119.6	42.4	57.2	65.1	28.4	46.3		°C/W

(1) For more information about traditional and new thermal metrics, see the [Semiconductor and IC Package Thermal Metrics](#) application report.

(2) The package thermal impedance is calculated in accordance with JESD 51-7.

(3) The package thermal impedance is calculated in accordance with JESD 51-5.

SN74LVC244A

SCAS414AB – NOVEMBER 1992 – REVISED NOVEMBER 2016

www.ti.com

Thermal Information (continued)

THERMAL METRIC ⁽¹⁾	SN74LVC244A									UNIT
	DB ⁽²⁾ (SSOP)	DGV ⁽²⁾ (TVSOP)	DW ⁽²⁾ (SOIC)	ZQN ⁽²⁾ (BGA)	N ⁽²⁾ (PDIP)	NS ⁽²⁾ (SO)	PW ⁽²⁾ (TSSOP)	RGY ⁽³⁾ (VQFN)	RWP ⁽³⁾ (X1QFN)	
	20 PINS									
R _{thJC(bot)} Junction-to-case (bottom) thermal resistance	—	—	—	n/a	—	—	—	22.7	27.3	°C/W

6.5 Electrical Characteristics

over recommended operating free-air temperature range (unless otherwise noted)

PARAMETER	TEST CONDITIONS	V _{CC}	T _A = 25°C			-40 TO +85°C		-40 TO +125°C		UNIT	
			MIN	TYP	MAX	MIN	MAX	MIN	MAX		
V _{OH}	I _{OH} = -100 μA	1.65 V to 3.6 V	V _{CC} - 0.2			V _{CC} - 0.2		V _{CC} - 0.3		V	
	I _{OH} = -4 mA	1.65 V	1.29			1.2		1.05			
	I _{OH} = -8 mA	2.3 V	1.9			1.7		1.55			
	I _{OH} = -12 mA	2.7 V	2.2			2.2		2.05			
		3 V	2.4			2.4		2.25			
I _{OH} = -24 mA	3 V	2.3			2.2		2				
V _{OL}	I _{OL} = 100 μA	1.65 V to 3.6 V	0.1			0.2		0.3		V	
	I _{OL} = 4 mA	1.65 V	0.24			0.45		0.6			
	I _{OL} = 8 mA	2.3 V	0.3			0.7		0.75			
	I _{OL} = 12 mA	2.7 V	0.4			0.4		0.6			
	I _{OL} = 24 mA	3 V	0.55			0.55		0.8			
I _I	V _I = 5.5 V or GND	3.6 V	±1			±5		±20		μA	
I _{off}	V _I or V _O = 5.5 V	0	±1			±10		±20		μA	
I _{OZ}	V _O = 0 to 5.5 V	3.6 V	±1			±10		±20		μA	
I _{CC}	V _I = V _{CC} or GND	3.6 V	I _O = 0			1		10		40	
	3.6 V ≤ V _I ≤ 5.5 V ⁽¹⁾					1		10		40	
ΔI _{CC}	One input at V _{CC} - 0.6 V, Other inputs at V _{CC} or GND	2.7 V to 3.6 V	500			500		5000		μA	
C _i	V _I = V _{CC} or GND	3.3 V	4							pF	
C _o	V _O = V _{CC} or GND	3.3 V	5.5							pF	

(1) This applies in the disabled state only.

6.6 Switching Characteristics

over recommended operating free-air temperature range (unless otherwise noted) (see Figure 3)

PARAMETER	FROM (INPUT)	TO (OUTPUT)	V _{CC}	T _A = 25°C			-40 TO +85°C		-40 TO +125°C		UNIT
				MIN	TYP	MAX	MIN	MAX	MIN	MAX	
t _{pd}	A	Y	1.5 V	1	7	14.4	1	14.9	1	16.4	ns
			1.8 V ± 0.15 V	1	5.9	10.4	1	10.9	1	12.4	
			2.5 V ± 0.2 V	1	4.2	7.4	1	7.9	1	10	
			2.7 V	1	4.2	6.7	1	6.9	1	8.2	
			3.3 V ± 0.3 V	1.5	3.9	5.7	1.5	5.9	1.5	7.2	

Switching Characteristics (continued)

over recommended operating free-air temperature range (unless otherwise noted) (see Figure 3)

PARAMETER	FROM (INPUT)	TO (OUTPUT)	V _{CC}	T _A = 25°C			-40 TO +85°C		-40 TO +125°C		UNIT
				MIN	TYP	MAX	MIN	MAX	MIN	MAX	
t _{en}	\overline{OE}	Y	1.5 V	1	8.3	17.8	1	18.3	1	19.8	ns
			1.8 V ± 0.15 V	1	6.4	12.1	1	12.6	1	14.1	
			2.5 V ± 0.2 V	1	4.6	9.1	1	9.6	1	11.7	
			2.7 V	1	5	8.4	1	8.6	1	10.3	
t _{dis}	\overline{OE}	Y	1.5 V	1	7.2	15.6	1	16.1	1	17.6	ns
			1.8 V ± 0.15 V	1	5.8	11.6	1	12.1	1	13.6	
			2.5 V ± 0.2 V	1	3.7	7.3	1	7.8	1	9.9	
			2.7 V	1	3.8	6.6	1	6.8	1	8.6	
t _{sk(o)}			3.3 V ± 0.3 V				1		1.5	ns	

6.7 Operating Characteristics

T_A = 25°C

PARAMETER		TEST CONDITIONS	V _{CC}	TYP	UNIT	
C _{pd}	Power dissipation capacitance per buffer/driver	Outputs enabled	f = 10 MHz	1.8 V	43	pF
				2.5 V	43	
				3.3 V	44	
		Outputs disabled	f = 10 MHz	1.8 V	1	
				2.5 V	1	
				3.3 V	2	

6.8 Typical Characteristics

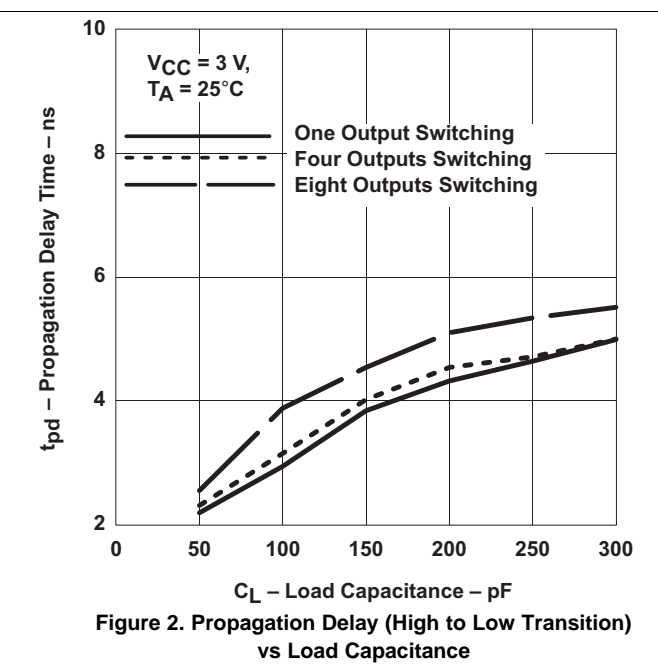
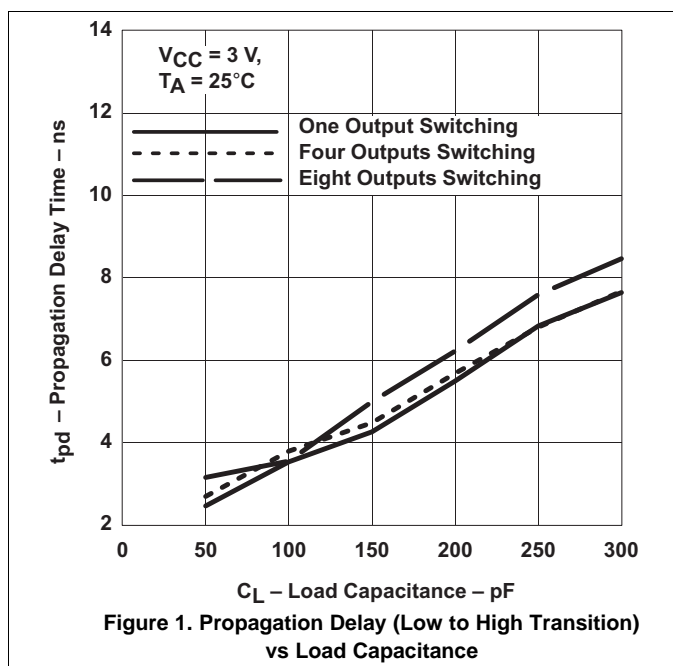

7 Parameter Measurement Information

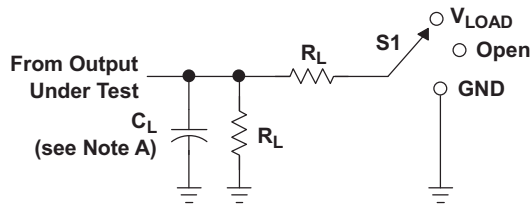
LOAD CIRCUIT

TEST	S1
t_{PLH}/t_{PHL}	Open
t_{PLZ}/t_{PZL}	V_{LOAD}
t_{PHZ}/t_{PZH}	GND

V_{CC}	INPUTS		V_M	V_{LOAD}	C_L	R_L	V_{Δ}
	V_I	t_r/t_f					
1.5 V	V_{CC}	≤ 2 ns	$V_{CC}/2$	$2 \times V_{CC}$	15 pF	2 k Ω	0.1 V
1.8 V \pm 0.15 V	V_{CC}	≤ 2 ns	$V_{CC}/2$	$2 \times V_{CC}$	30 pF	1 k Ω	0.15 V
2.5 V \pm 0.2 V	V_{CC}	≤ 2 ns	$V_{CC}/2$	$2 \times V_{CC}$	30 pF	500 Ω	0.15 V
2.7 V	2.7 V	≤ 2.5 ns	1.5 V	6 V	50 pF	500 Ω	0.3 V
3.3 V \pm 0.3 V	2.7 V	≤ 2.5 ns	1.5 V	6 V	50 pF	500 Ω	0.3 V

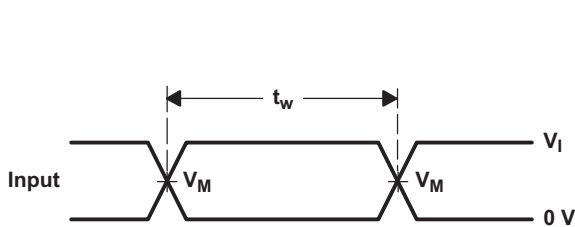
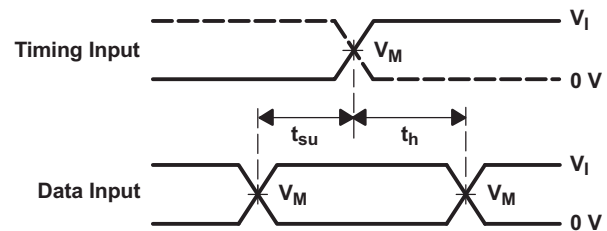
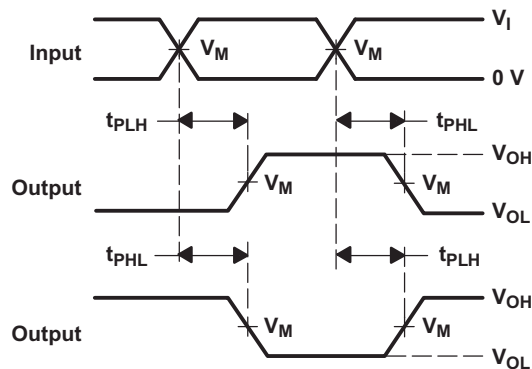
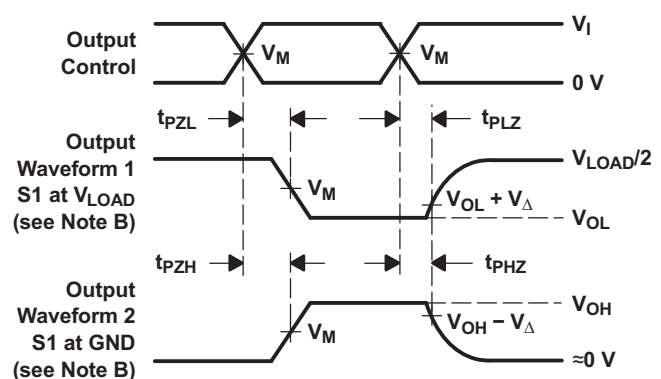
**VOLTAGE WAVEFORMS
PULSE DURATION**

**VOLTAGE WAVEFORMS
SETUP AND HOLD TIMES**

**VOLTAGE WAVEFORMS
PROPAGATION DELAY TIMES
INVERTING AND NONINVERTING OUTPUTS**

**VOLTAGE WAVEFORMS
ENABLE AND DISABLE TIMES
LOW- AND HIGH-LEVEL ENABLING**

- NOTES:
- C_L includes probe and jig capacitance.
 - Waveform 1 is for an output with internal conditions such that the output is low, except when disabled by the output control. Waveform 2 is for an output with internal conditions such that the output is high, except when disabled by the output control.
 - All input pulses are supplied by generators having the following characteristics: $PRR \leq 10$ MHz, $Z_O = 50 \Omega$.
 - The outputs are measured one at a time, with one transition per measurement.
 - t_{PLZ} and t_{PHZ} are the same as t_{dis} .
 - t_{PZL} and t_{PZH} are the same as t_{en} .
 - t_{PLH} and t_{PHL} are the same as t_{pd} .
 - All parameters and waveforms are not applicable to all devices.

Figure 3. Load Circuit and Voltage Waveforms

8 Detailed Description

8.1 Overview

The SN74LVC244A device is organized as two 4-bit buffers/line drivers with separate output-enable (\overline{OE}) inputs. The device passes data from the A inputs to the Y outputs when \overline{OE} is low. The outputs are in the high-impedance state when \overline{OE} is high. \overline{OE} should be tied to V_{CC} through a pullup resistor to ensure the high-impedance state during power up or power down; the minimum value of the resistor is determined by the current-sinking capability of the driver.

8.2 Functional Block Diagram

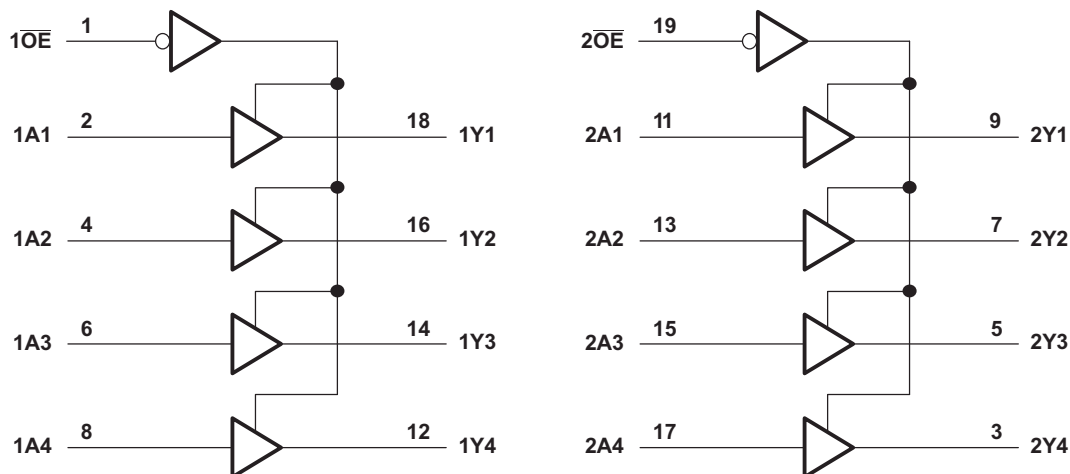

Pin numbers shown are for the DB, DGV, DW, N, NS, PW, and RGY packages.

Figure 4. Logic Diagram (Positive Logic)

8.3 Feature Description

- Allows down voltage translation
 - 5 V to 3.3 V
 - 5 V or 3.3 V to 1.8 V
- Inputs accept voltage levels up to 5.5 V
- It is available in ultra small logic 20 pin QFN package at 0.5 mm max height with 0.4 mm pitch.

8.4 Device Functional Modes

Table 1 lists the functional modes of the SN74LVC244A.

Table 1. Function Table

INPUTS		OUTPUT Y
\overline{OE}	A	
L	H	H
L	L	L
H	X	Hi-Z

9 Application and Implementation

NOTE

Information in the following applications sections is not part of the TI component specification, and TI does not warrant its accuracy or completeness. TI's customers are responsible for determining suitability of components for their purposes. Customers should validate and test their design implementation to confirm system functionality.

9.1 Application Information

SN74LVC244A is a high drive CMOS device that can be used for a multitude of bus interface type applications where output drive or PCB trace length is a concern. The inputs can accept voltages to 5.5 V at any valid V_{CC} making it ideal for down translation.

9.2 Typical Application

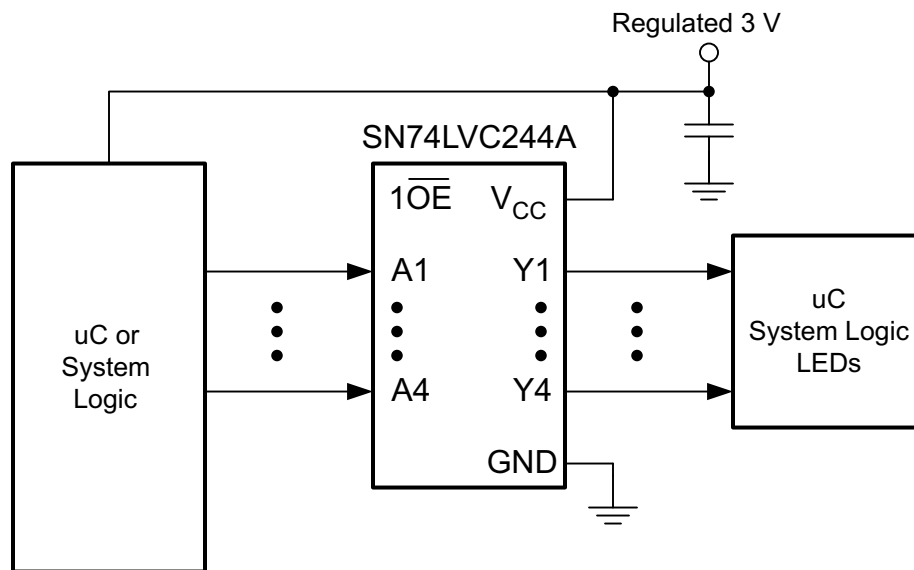

Figure 5. Application Schematic

9.2.1 Design Requirements

This device uses CMOS technology and has balanced output drive. Avoid bus contention because it can drive currents in excess of maximum limits. The high drive will also create fast edges into light loads, so consider routing and load conditions to prevent ringing.

9.2.2 Detailed Design Procedure

1. Recommended Input Conditions:

- For rise time and fall time specification, see $(\Delta t/\Delta V)$ in the [Recommended Operating Conditions](#) table.
- For specified high and low levels, see $(V_{IH}$ and $V_{IL})$ in the [Recommended Operating Conditions](#) table.
- Inputs are overvoltage tolerant allowing them to go as high as $(V_I \text{ max})$ in the [Recommended Operating Conditions](#) table at any valid V_{CC} .

2. Recommended maximum Output Conditions:

- Load currents should not exceed $(I_O \text{ max})$ per output and should not exceed (Continuous current through V_{CC} or GND) total current for the part. These limits are located in the [Absolute Maximum Ratings](#) table.
- Outputs should not be pulled above V_{CC} .

Typical Application (continued)

9.2.3 Application Curves

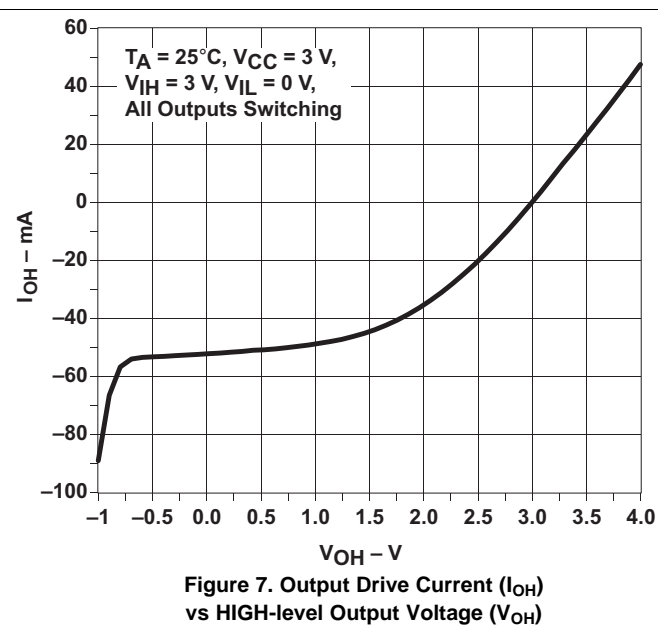
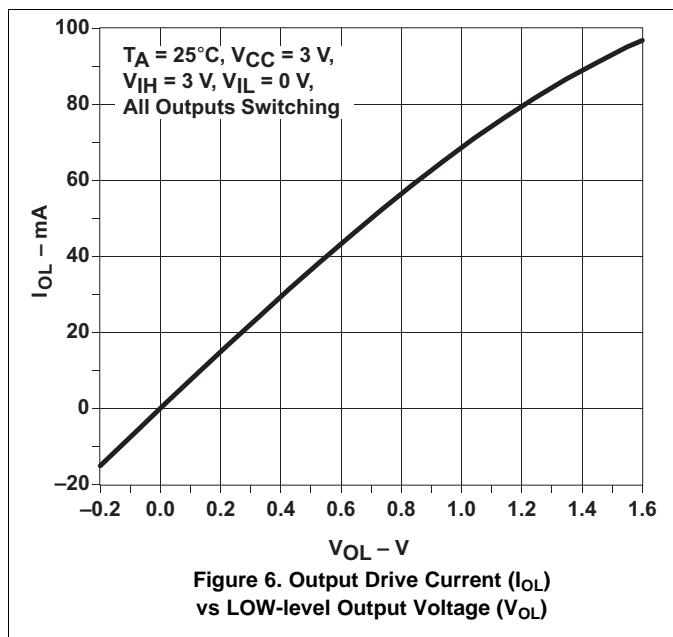

10 Power Supply Recommendations

The power supply may be any voltage between the MIN and MAX supply voltage rating located in the [Recommended Operating Conditions](#) table.

Each V_{CC} terminal should have a good bypass capacitor to prevent power disturbance. A 0.1 μF capacitor is recommended for devices with a single supply. If there are multiple V_{CC} terminals, then 0.01 μF or 0.022 μF capacitors are recommended for each power terminal. It is permissible to parallel multiple bypass capacitors to reject different frequencies of noise. Multiple bypass capacitors may be paralleled to reject different frequencies of noise. The bypass capacitor should be installed as close to the power terminal as possible for the best results.

11 Layout

11.1 Layout Guidelines

Inputs should not float when using multiple bit logic devices. In many cases, functions or parts of functions of digital logic devices are unused. Some examples include situations when only two inputs of a triple-input AND gate are used, or when only 3 of the 4-buffer gates are used. Such input pins should not be left unconnected because the undefined voltages at the outside connections result in undefined operational states.

Specified in [Figure 8](#) are rules that must be observed under all circumstances. All unused inputs of digital logic devices must be connected to a high or low bias to prevent them from floating. The logic level that should be applied to any particular unused input depends on the function of the device. Generally, they will be tied to GND or V_{CC} , whichever makes more sense or is more convenient.

11.2 Layout Example

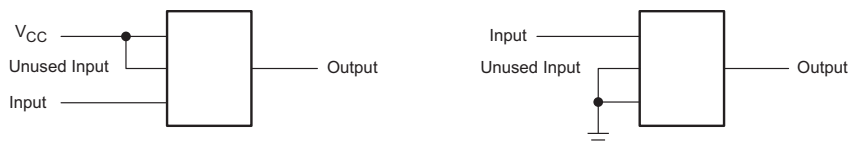

Figure 8. Layout Diagram

12 Device and Documentation Support

12.1 Receiving Notification of Documentation Updates

To receive notification of documentation updates, navigate to the device product folder on ti.com. In the upper right corner, click on *Alert me* to register and receive a weekly digest of any product information that has changed. For change details, review the revision history included in any revised document.

12.2 Community Resources

The following links connect to TI community resources. Linked contents are provided "AS IS" by the respective contributors. They do not constitute TI specifications and do not necessarily reflect TI's views; see TI's [Terms of Use](#).

TI E2E™ Online Community *TI's Engineer-to-Engineer (E2E) Community*. Created to foster collaboration among engineers. At e2e.ti.com, you can ask questions, share knowledge, explore ideas and help solve problems with fellow engineers.

Design Support *TI's Design Support* Quickly find helpful E2E forums along with design support tools and contact information for technical support.

12.3 Trademarks

E2E is a trademark of Texas Instruments.
All other trademarks are the property of their respective owners.

12.4 Electrostatic Discharge Caution



These devices have limited built-in ESD protection. The leads should be shorted together or the device placed in conductive foam during storage or handling to prevent electrostatic damage to the MOS gates.

12.5 Glossary

[SLYZ022](#) — *TI Glossary*.

This glossary lists and explains terms, acronyms, and definitions.

13 Mechanical, Packaging, and Orderable Information

The following pages include mechanical packaging and orderable information. This information is the most current data available for the designated devices. This data is subject to change without notice and revision of this document. For browser based versions of this data sheet, refer to the left hand navigation.

PACKAGING INFORMATION

Orderable Device	Status (1)	Package Type	Package Drawing	Pins	Package Qty	Eco Plan (2)	Lead/Ball Finish (6)	MSL Peak Temp (3)	Op Temp (°C)	Device Marking (4/5)	Samples
SN74LVC244ADBR	ACTIVE	SSOP	DB	20	2000	Green (RoHS & no Sb/Br)	CU NIPDAU	Level-1-260C-UNLIM	-40 to 125	LC244A	Samples
SN74LVC244ADBRE4	ACTIVE	SSOP	DB	20	2000	Green (RoHS & no Sb/Br)	CU NIPDAU	Level-1-260C-UNLIM	-40 to 125	LC244A	Samples
SN74LVC244ADBRG4	ACTIVE	SSOP	DB	20	2000	Green (RoHS & no Sb/Br)	CU NIPDAU	Level-1-260C-UNLIM	-40 to 125	LC244A	Samples
SN74LVC244ADGVR	ACTIVE	TVSOP	DGV	20	2000	Green (RoHS & no Sb/Br)	CU NIPDAU	Level-1-260C-UNLIM	-40 to 125	LC244A	Samples
SN74LVC244ADGVRE4	ACTIVE	TVSOP	DGV	20	2000	Green (RoHS & no Sb/Br)	CU NIPDAU	Level-1-260C-UNLIM	-40 to 125	LC244A	Samples
SN74LVC244ADGVRG4	ACTIVE	TVSOP	DGV	20	2000	Green (RoHS & no Sb/Br)	CU NIPDAU	Level-1-260C-UNLIM	-40 to 125	LC244A	Samples
SN74LVC244ADW	ACTIVE	SOIC	DW	20	25	Green (RoHS & no Sb/Br)	CU NIPDAU	Level-1-260C-UNLIM	-40 to 125	LVC244A	Samples
SN74LVC244ADWE4	ACTIVE	SOIC	DW	20	25	Green (RoHS & no Sb/Br)	CU NIPDAU	Level-1-260C-UNLIM	-40 to 125	LVC244A	Samples
SN74LVC244ADWG4	ACTIVE	SOIC	DW	20	25	Green (RoHS & no Sb/Br)	CU NIPDAU	Level-1-260C-UNLIM	-40 to 125	LVC244A	Samples
SN74LVC244ADWR	ACTIVE	SOIC	DW	20	2000	Green (RoHS & no Sb/Br)	CU NIPDAU CU SN	Level-1-260C-UNLIM	-40 to 125	LVC244A	Samples
SN74LVC244ADWRE4	ACTIVE	SOIC	DW	20	2000	Green (RoHS & no Sb/Br)	CU NIPDAU	Level-1-260C-UNLIM	-40 to 125	LVC244A	Samples
SN74LVC244ADWRG4	ACTIVE	SOIC	DW	20	2000	Green (RoHS & no Sb/Br)	CU NIPDAU	Level-1-260C-UNLIM	-40 to 125	LVC244A	Samples
SN74LVC244AN	ACTIVE	PDIP	N	20	20	Pb-Free (RoHS)	CU NIPDAU	N / A for Pkg Type	-40 to 125	SN74LVC244AN	Samples
SN74LVC244ANE4	ACTIVE	PDIP	N	20	20	Pb-Free (RoHS)	CU NIPDAU	N / A for Pkg Type	-40 to 125	SN74LVC244AN	Samples
SN74LVC244ANSR	ACTIVE	SO	NS	20	2000	Green (RoHS & no Sb/Br)	CU NIPDAU	Level-1-260C-UNLIM	-40 to 125	LVC244A	Samples
SN74LVC244ANSRE4	ACTIVE	SO	NS	20	2000	Green (RoHS & no Sb/Br)	CU NIPDAU	Level-1-260C-UNLIM	-40 to 125	LVC244A	Samples
SN74LVC244APW	ACTIVE	TSSOP	PW	20	70	Green (RoHS & no Sb/Br)	CU NIPDAU	Level-1-260C-UNLIM	-40 to 125	LC244A	Samples

Orderable Device	Status (1)	Package Type	Package Drawing	Pins	Package Qty	Eco Plan (2)	Lead/Ball Finish (6)	MSL Peak Temp (3)	Op Temp (°C)	Device Marking (4/5)	Samples
SN74LVC244APWE4	ACTIVE	TSSOP	PW	20	70	Green (RoHS & no Sb/Br)	CU NIPDAU	Level-1-260C-UNLIM	-40 to 125	LC244A	Samples
SN74LVC244APWG4	ACTIVE	TSSOP	PW	20	70	Green (RoHS & no Sb/Br)	CU NIPDAU	Level-1-260C-UNLIM	-40 to 125	LC244A	Samples
SN74LVC244APWR	ACTIVE	TSSOP	PW	20	2000	Green (RoHS & no Sb/Br)	CU NIPDAU CU SN	Level-1-260C-UNLIM	-40 to 125	LC244A	Samples
SN74LVC244APWRE4	ACTIVE	TSSOP	PW	20	2000	Green (RoHS & no Sb/Br)	CU NIPDAU	Level-1-260C-UNLIM	-40 to 125	LC244A	Samples
SN74LVC244APWRG3	ACTIVE	TSSOP	PW	20	2000	Green (RoHS & no Sb/Br)	CU SN	Level-1-260C-UNLIM	-40 to 125	LC244A	Samples
SN74LVC244APWRG4	ACTIVE	TSSOP	PW	20	2000	Green (RoHS & no Sb/Br)	CU NIPDAU	Level-1-260C-UNLIM	-40 to 125	LC244A	Samples
SN74LVC244APWT	ACTIVE	TSSOP	PW	20	250	Green (RoHS & no Sb/Br)	CU NIPDAU	Level-1-260C-UNLIM	-40 to 125	LC244A	Samples
SN74LVC244APWTE4	ACTIVE	TSSOP	PW	20	250	Green (RoHS & no Sb/Br)	CU NIPDAU	Level-1-260C-UNLIM	-40 to 125	LC244A	Samples
SN74LVC244APWTG4	ACTIVE	TSSOP	PW	20	250	Green (RoHS & no Sb/Br)	CU NIPDAU	Level-1-260C-UNLIM	-40 to 125	LC244A	Samples
SN74LVC244ARGYR	ACTIVE	VQFN	RGY	20	3000	Green (RoHS & no Sb/Br)	CU NIPDAU	Level-2-260C-1 YEAR	-40 to 125	LC244A	Samples
SN74LVC244ARGYRG4	ACTIVE	VQFN	RGY	20	3000	Green (RoHS & no Sb/Br)	CU NIPDAU	Level-2-260C-1 YEAR	-40 to 125	LC244A	Samples
SN74LVC244ARWPR	ACTIVE	X1QFN	RWP	20	2000	Green (RoHS & no Sb/Br)	CU NIPDAU	Level-1-260C-UNLIM	-40 to 125	LC244A	Samples
SN74LVC244AZQNR	ACTIVE	BGA MICROSTAR JUNIOR	ZQN	20	1000	Green (RoHS & no Sb/Br)	SNAGCU	Level-1-260C-UNLIM	-40 to 85	LC244A	Samples

(1) The marketing status values are defined as follows:

ACTIVE: Product device recommended for new designs.

LIFEBUY: TI has announced that the device will be discontinued, and a lifetime-buy period is in effect.

NRND: Not recommended for new designs. Device is in production to support existing customers, but TI does not recommend using this part in a new design.

PREVIEW: Device has been announced but is not in production. Samples may or may not be available.

OBSELETE: TI has discontinued the production of the device.

(2) Eco Plan - The planned eco-friendly classification: Pb-Free (RoHS), Pb-Free (RoHS Exempt), or Green (RoHS & no Sb/Br) - please check <http://www.ti.com/productcontent> for the latest availability information and additional product content details.

TBD: The Pb-Free/Green conversion plan has not been defined.

Pb-Free (RoHS): TI's terms "Lead-Free" or "Pb-Free" mean semiconductor products that are compatible with the current RoHS requirements for all 6 substances, including the requirement that lead not exceed 0.1% by weight in homogeneous materials. Where designed to be soldered at high temperatures, TI Pb-Free products are suitable for use in specified lead-free processes.

Pb-Free (RoHS Exempt): This component has a RoHS exemption for either 1) lead-based flip-chip solder bumps used between the die and package, or 2) lead-based die adhesive used between the die and leadframe. The component is otherwise considered Pb-Free (RoHS compatible) as defined above.

Green (RoHS & no Sb/Br): TI defines "Green" to mean Pb-Free (RoHS compatible), and free of Bromine (Br) and Antimony (Sb) based flame retardants (Br or Sb do not exceed 0.1% by weight in homogeneous material)

(3) MSL, Peak Temp. - The Moisture Sensitivity Level rating according to the JEDEC industry standard classifications, and peak solder temperature.

(4) There may be additional marking, which relates to the logo, the lot trace code information, or the environmental category on the device.

(5) Multiple Device Markings will be inside parentheses. Only one Device Marking contained in parentheses and separated by a "~" will appear on a device. If a line is indented then it is a continuation of the previous line and the two combined represent the entire Device Marking for that device.

(6) Lead/Ball Finish - Orderable Devices may have multiple material finish options. Finish options are separated by a vertical ruled line. Lead/Ball Finish values may wrap to two lines if the finish value exceeds the maximum column width.

Important Information and Disclaimer: The information provided on this page represents TI's knowledge and belief as of the date that it is provided. TI bases its knowledge and belief on information provided by third parties, and makes no representation or warranty as to the accuracy of such information. Efforts are underway to better integrate information from third parties. TI has taken and continues to take reasonable steps to provide representative and accurate information but may not have conducted destructive testing or chemical analysis on incoming materials and chemicals. TI and TI suppliers consider certain information to be proprietary, and thus CAS numbers and other limited information may not be available for release.

In no event shall TI's liability arising out of such information exceed the total purchase price of the TI part(s) at issue in this document sold by TI to Customer on an annual basis.

OTHER QUALIFIED VERSIONS OF SN74LVC244A :

- Automotive: [SN74LVC244A-Q1](#)

NOTE: Qualified Version Definitions:

- Automotive - Q100 devices qualified for high-reliability automotive applications targeting zero defects

TAPE AND REEL INFORMATION



QUADRANT ASSIGNMENTS FOR PIN 1 ORIENTATION IN TAPE



*All dimensions are nominal

Device	Package Type	Package Drawing	Pins	SPQ	Reel Diameter (mm)	Reel Width W1 (mm)	A0 (mm)	B0 (mm)	K0 (mm)	P1 (mm)	W (mm)	Pin1 Quadrant
SN74LVC244ADBR	SSOP	DB	20	2000	330.0	16.4	8.2	7.5	2.5	12.0	16.0	Q1
SN74LVC244ADGVR	TVSOP	DGV	20	2000	330.0	12.4	6.9	5.6	1.6	8.0	12.0	Q1
SN74LVC244ADWR	SOIC	DW	20	2000	330.0	24.4	10.8	13.3	2.7	12.0	24.0	Q1
SN74LVC244ADWR	SOIC	DW	20	2000	330.0	24.4	10.8	13.3	2.7	12.0	24.0	Q1
SN74LVC244ADWRG4	SOIC	DW	20	2000	330.0	24.4	10.8	13.3	2.7	12.0	24.0	Q1
SN74LVC244ANSR	SO	NS	20	2000	330.0	24.4	8.4	13.0	2.5	12.0	24.0	Q1
SN74LVC244APWR	TSSOP	PW	20	2000	330.0	16.4	6.95	7.1	1.6	8.0	16.0	Q1
SN74LVC244APWRG3	TSSOP	PW	20	2000	330.0	16.4	6.95	7.1	1.6	8.0	16.0	Q1
SN74LVC244APWT	TSSOP	PW	20	250	330.0	16.4	6.95	7.1	1.6	8.0	16.0	Q1
SN74LVC244ARGYR	VQFN	RGY	20	3000	330.0	12.4	3.8	4.8	1.6	8.0	12.0	Q1
SN74LVC244ARWPR	X1QFN	RWP	20	2000	178.0	13.5	2.85	3.65	0.75	8.0	12.0	Q1
SN74LVC244AZQNR	BGA MICROSTAR JUNIOR	ZQN	20	1000	330.0	12.4	3.3	4.3	1.6	8.0	12.0	Q1

TAPE AND REEL BOX DIMENSIONS

*All dimensions are nominal

Device	Package Type	Package Drawing	Pins	SPQ	Length (mm)	Width (mm)	Height (mm)
SN74LVC244ADBR	SSOP	DB	20	2000	367.0	367.0	38.0
SN74LVC244ADGVR	TVSOP	DGV	20	2000	367.0	367.0	35.0
SN74LVC244ADWR	SOIC	DW	20	2000	364.0	361.0	36.0
SN74LVC244ADWR	SOIC	DW	20	2000	367.0	367.0	45.0
SN74LVC244ADWRG4	SOIC	DW	20	2000	367.0	367.0	45.0
SN74LVC244ANSR	SO	NS	20	2000	367.0	367.0	45.0
SN74LVC244APWR	TSSOP	PW	20	2000	364.0	364.0	27.0
SN74LVC244APWRG3	TSSOP	PW	20	2000	364.0	364.0	27.0
SN74LVC244APWT	TSSOP	PW	20	250	367.0	367.0	38.0
SN74LVC244ARGYR	VQFN	RGY	20	3000	355.0	350.0	50.0
SN74LVC244ARWPR	X1QFN	RWP	20	2000	189.0	185.0	36.0
SN74LVC244AZQNR	BGA MICROSTAR JUNIOR	ZQN	20	1000	336.6	336.6	28.6

RGY (R-PVQFN-N20)

PLASTIC QUAD FLATPACK NO-LEAD

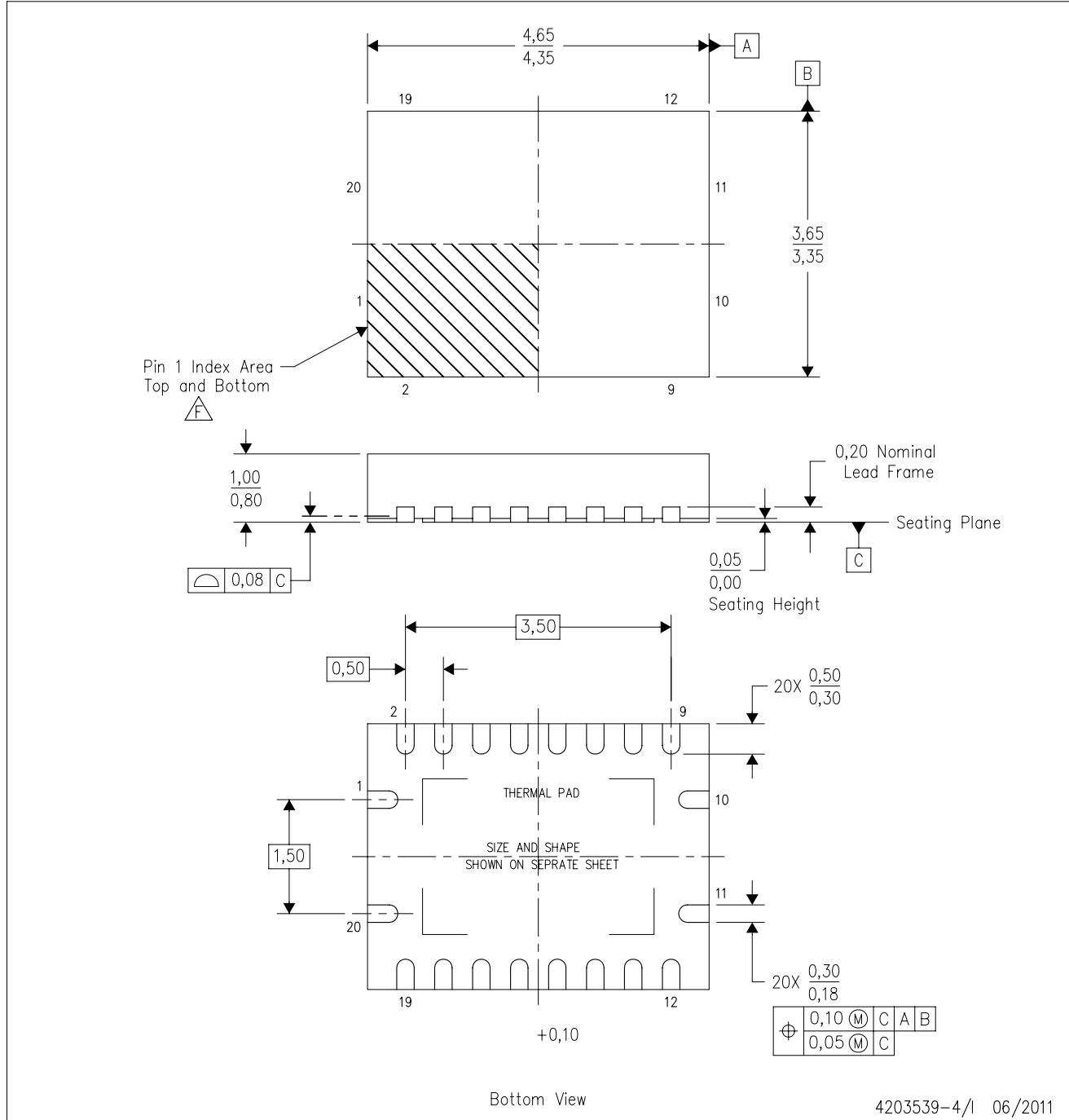

- NOTES:
- All linear dimensions are in millimeters. Dimensioning and tolerancing per ASME Y14.5M-1994.
 - This drawing is subject to change without notice.
 - QFN (Quad Flatpack No-Lead) package configuration.
 - The package thermal pad must be soldered to the board for thermal and mechanical performance.
 - See the additional figure in the Product Data Sheet for details regarding the exposed thermal pad features and dimensions.
 - △ Pin 1 identifiers are located on both top and bottom of the package and within the zone indicated. The Pin 1 identifiers are either a molded, marked, or metal feature.
 - Package complies to JEDEC MO-241 variation BA.

RGY (R-PVQFN-N20)

PLASTIC QUAD FLATPACK NO-LEAD

THERMAL INFORMATION

This package incorporates an exposed thermal pad that is designed to be attached directly to an external heatsink. The thermal pad must be soldered directly to the printed circuit board (PCB). After soldering, the PCB can be used as a heatsink. In addition, through the use of thermal vias, the thermal pad can be attached directly to the appropriate copper plane shown in the electrical schematic for the device, or alternatively, can be attached to a special heatsink structure designed into the PCB. This design optimizes the heat transfer from the integrated circuit (IC).

For information on the Quad Flatpack No-Lead (QFN) package and its advantages, refer to Application Report, QFN/SON PCB Attachment, Texas Instruments Literature No. SLUA271. This document is available at www.ti.com.

The exposed thermal pad dimensions for this package are shown in the following illustration.

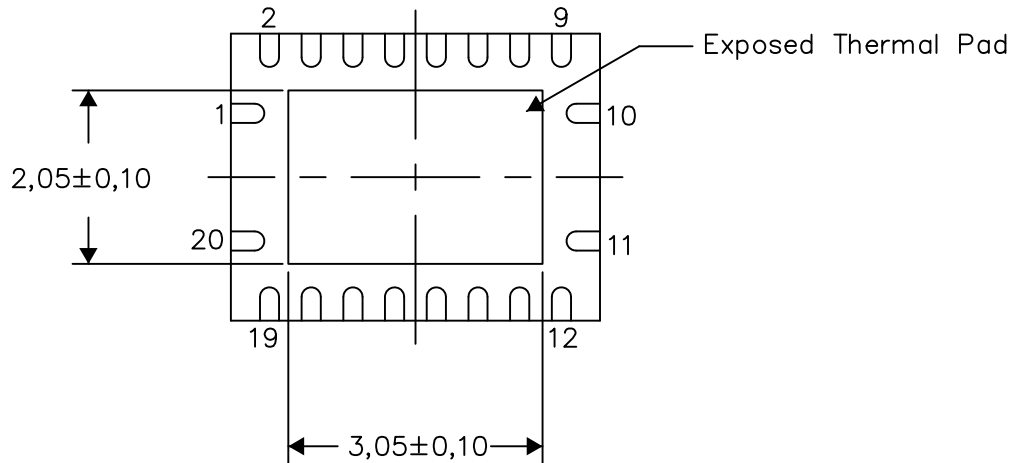

Bottom View

Exposed Thermal Pad Dimensions

4206353-4/P 03/14

NOTE: All linear dimensions are in millimeters

RGY (R-PVQFN-N20)

PLASTIC QUAD FLATPACK NO-LEAD



- NOTES:
- A. All linear dimensions are in millimeters.
 - B. This drawing is subject to change without notice.
 - C. Publication IPC-7351 is recommended for alternate designs.
 - D. This package is designed to be soldered to a thermal pad on the board. Refer to Application Note, Quad Flat-Pack QFN/SON PCB Attachment, Texas Instruments Literature No. SLUA271, and also the Product Data Sheets for specific thermal information, via requirements, and recommended board layout. These documents are available at www.ti.com <<http://www.ti.com>>.
 - E. Laser cutting apertures with trapezoidal walls and also rounding corners will offer better paste release. Customers should contact their board assembly site for stencil design recommendations. Refer to IPC 7525 for stencil design considerations.
 - F. Customers should contact their board fabrication site for minimum solder mask web tolerances between signal pads.

MECHANICAL DATA

NS (R-PDSO-G**)

PLASTIC SMALL-OUTLINE PACKAGE

14-PINS SHOWN



- NOTES:
- A. All linear dimensions are in millimeters.
 - B. This drawing is subject to change without notice.
 - C. Body dimensions do not include mold flash or protrusion, not to exceed 0,15.

PW (R-PDSO-G20)

PLASTIC SMALL OUTLINE



- NOTES:
- A. All linear dimensions are in millimeters.
 - B. This drawing is subject to change without notice.
 - C. Publication IPC-7351 is recommended for alternate design.
 - D. Laser cutting apertures with trapezoidal walls and also rounding corners will offer better paste release. Customers should contact their board assembly site for stencil design recommendations. Refer to IPC-7525 for other stencil recommendations.
 - E. Customers should contact their board fabrication site for solder mask tolerances between and around signal pads.

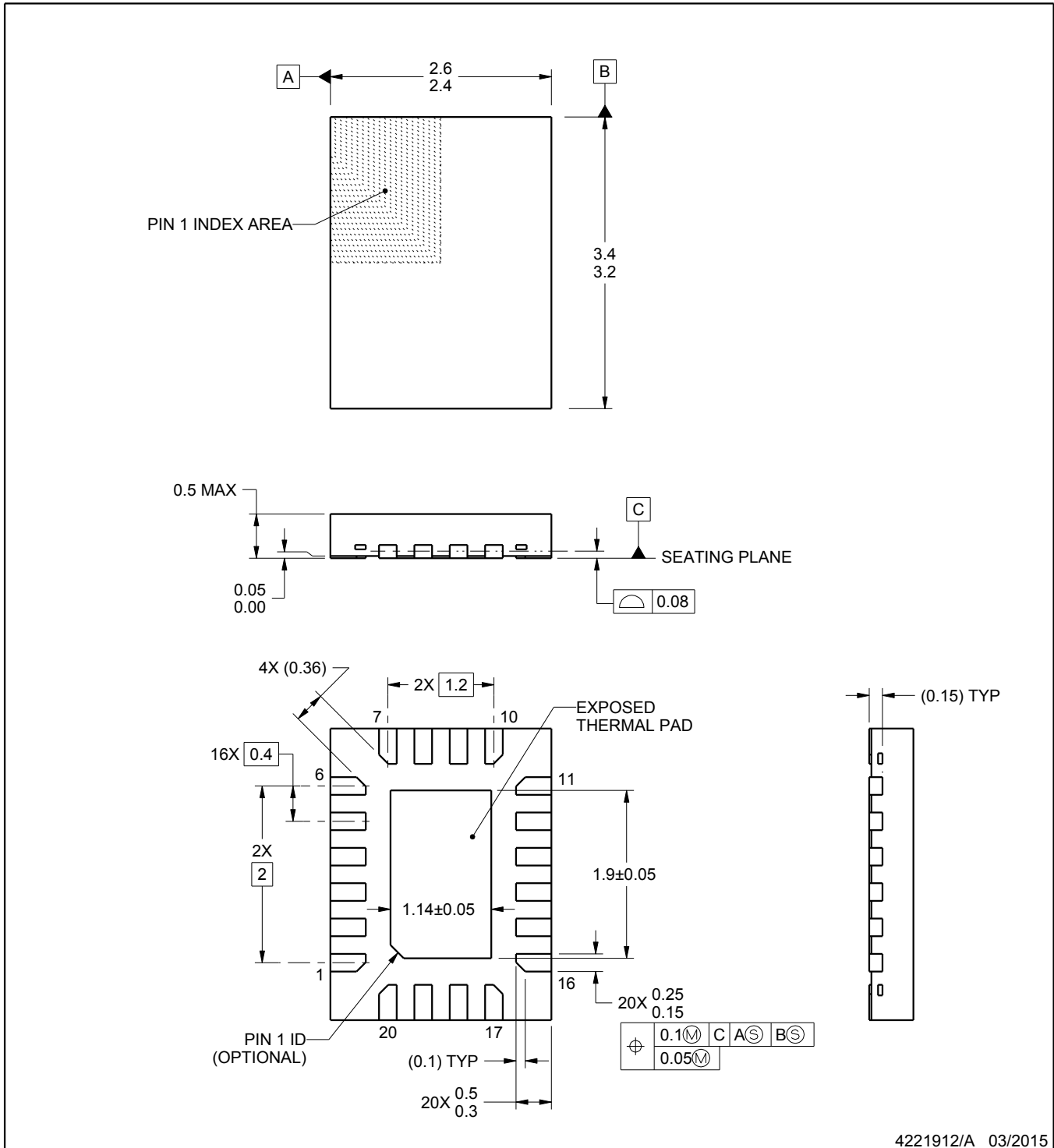
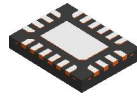

4221912/A 03/2015

NOTES:

1. All linear dimensions are in millimeters. Any dimensions in parenthesis are for reference only. Dimensioning and tolerancing per ASME Y14.5M.
2. This drawing is subject to change without notice.
3. The package thermal pad must be soldered to the printed circuit board for thermal and mechanical performance.

EXAMPLE STENCIL DESIGN

RWP0020A

X1QFN - 0.5 mm max height

PLASTIC QUAD FLATPACK - NO LEAD

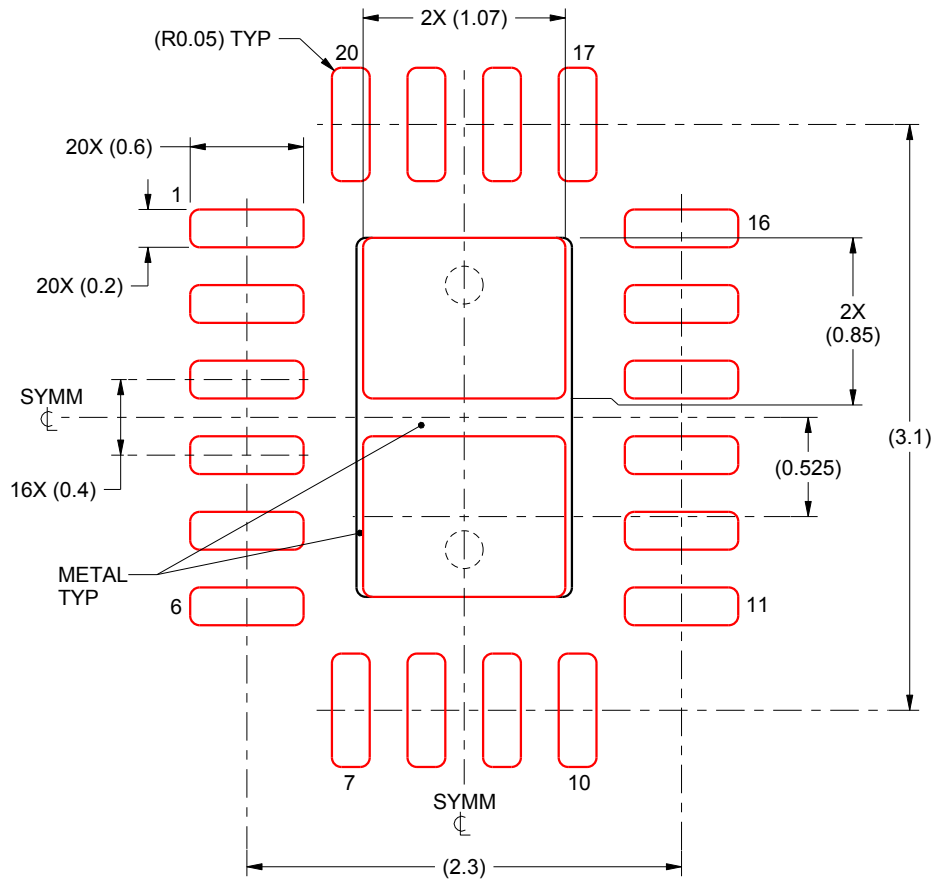

SOLDER PASTE EXAMPLE
BASED ON 0.1 mm THICK STENCIL

EXPOSED PAD
84% PRINTED SOLDER COVERAGE BY AREA
SCALE:25X

4221912/A 03/2015

NOTES: (continued)

5. Laser cutting apertures with trapezoidal walls and rounded corners may offer better paste release. IPC-7525 may have alternate design recommendations.

N (R-PDIP-T**)

PLASTIC DUAL-IN-LINE PACKAGE

16 PINS SHOWN



- NOTES:
- A. All linear dimensions are in inches (millimeters).
 - B. This drawing is subject to change without notice.
 - (C) Falls within JEDEC MS-001, except 18 and 20 pin minimum body length (Dim A).
 - (D) The 20 pin end lead shoulder width is a vendor option, either half or full width.

4040049/E 12/2002

DW0020A



PACKAGE OUTLINE

SOIC - 2.65 mm max height

SOIC



4220724/A 05/2016

EXAMPLE BOARD LAYOUT

DW0020A

SOIC - 2.65 mm max height

SOIC



LAND PATTERN EXAMPLE
SCALE:6X



SOLDER MASK DETAILS

4220724/A 05/2016

NOTES: (continued)

- 6. Publication IPC-7351 may have alternate designs.
- 7. Solder mask tolerances between and around signal pads can vary based on board fabrication site.

EXAMPLE STENCIL DESIGN

DW0020A

SOIC - 2.65 mm max height

SOIC



SOLDER PASTE EXAMPLE
BASED ON 0.125 mm THICK STENCIL
SCALE:6X

4220724/A 05/2016

NOTES: (continued)

8. Laser cutting apertures with trapezoidal walls and rounded corners may offer better paste release. IPC-7525 may have alternate design recommendations.
9. Board assembly site may have different recommendations for stencil design.

ZQN (R-PBGA-N20)

PLASTIC BALL GRID ARRAY

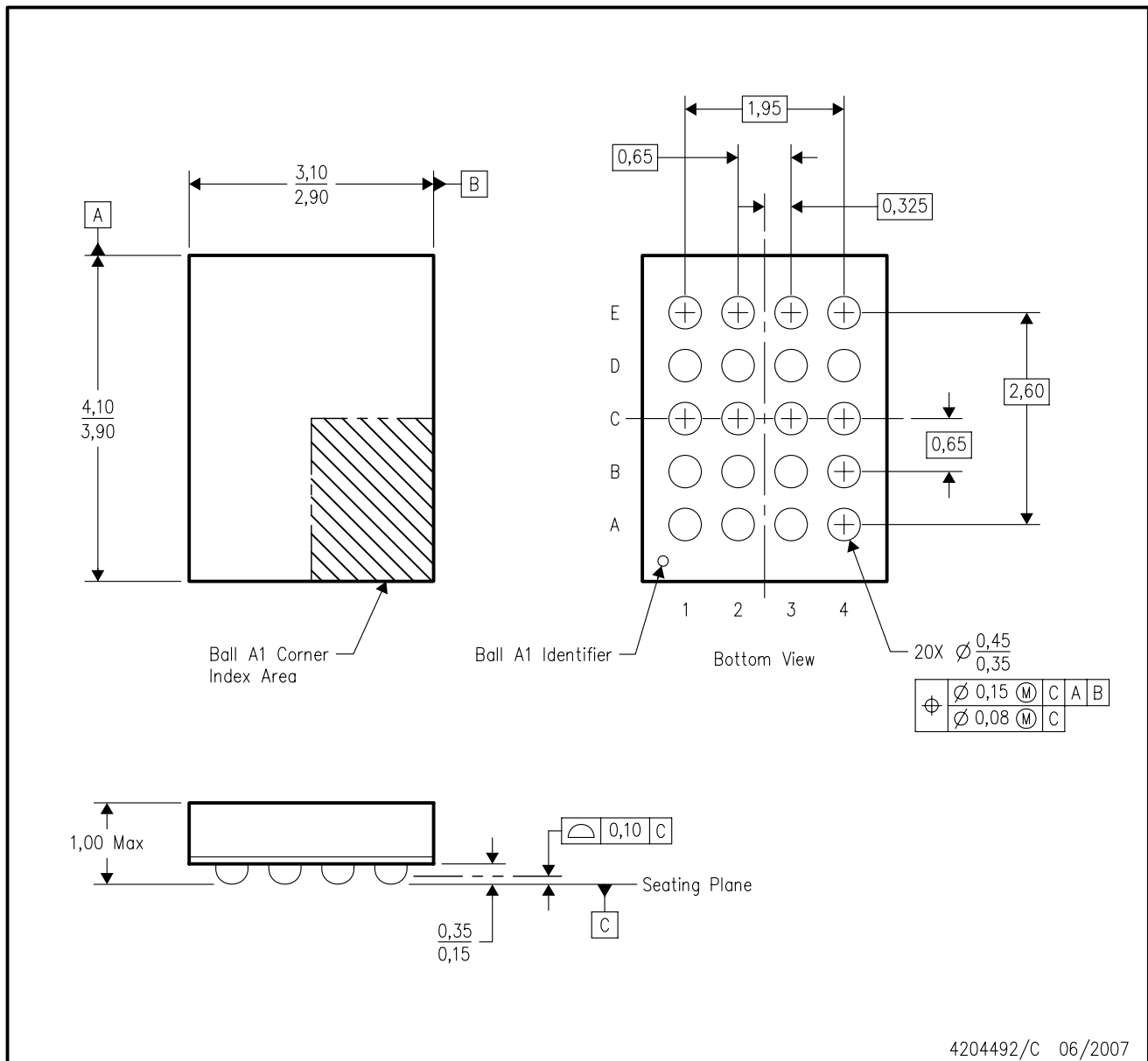

- NOTES:
- A. All linear dimensions are in millimeters. Dimensioning and tolerancing per ASME Y14.5M-1994.
 - B. This drawing is subject to change without notice.
 - C. Falls within JEDEC MO-285 variation BC-2.
 - D. This package is lead-free. Refer to the 20 GQN package (drawing 4200704) for tin-lead (SnPb).

IMPORTANT NOTICE

Texas Instruments Incorporated (TI) reserves the right to make corrections, enhancements, improvements and other changes to its semiconductor products and services per JESD46, latest issue, and to discontinue any product or service per JESD48, latest issue. Buyers should obtain the latest relevant information before placing orders and should verify that such information is current and complete.

TI's published terms of sale for semiconductor products (<http://www.ti.com/sc/docs/stdterms.htm>) apply to the sale of packaged integrated circuit products that TI has qualified and released to market. Additional terms may apply to the use or sale of other types of TI products and services.

Reproduction of significant portions of TI information in TI data sheets is permissible only if reproduction is without alteration and is accompanied by all associated warranties, conditions, limitations, and notices. TI is not responsible or liable for such reproduced documentation. Information of third parties may be subject to additional restrictions. Resale of TI products or services with statements different from or beyond the parameters stated by TI for that product or service voids all express and any implied warranties for the associated TI product or service and is an unfair and deceptive business practice. TI is not responsible or liable for any such statements.

Buyers and others who are developing systems that incorporate TI products (collectively, "Designers") understand and agree that Designers remain responsible for using their independent analysis, evaluation and judgment in designing their applications and that Designers have full and exclusive responsibility to assure the safety of Designers' applications and compliance of their applications (and of all TI products used in or for Designers' applications) with all applicable regulations, laws and other applicable requirements. Designer represents that, with respect to their applications, Designer has all the necessary expertise to create and implement safeguards that (1) anticipate dangerous consequences of failures, (2) monitor failures and their consequences, and (3) lessen the likelihood of failures that might cause harm and take appropriate actions. Designer agrees that prior to using or distributing any applications that include TI products, Designer will thoroughly test such applications and the functionality of such TI products as used in such applications.

TI's provision of technical, application or other design advice, quality characterization, reliability data or other services or information, including, but not limited to, reference designs and materials relating to evaluation modules, (collectively, "TI Resources") are intended to assist designers who are developing applications that incorporate TI products; by downloading, accessing or using TI Resources in any way, Designer (individually or, if Designer is acting on behalf of a company, Designer's company) agrees to use any particular TI Resource solely for this purpose and subject to the terms of this Notice.

TI's provision of TI Resources does not expand or otherwise alter TI's applicable published warranties or warranty disclaimers for TI products, and no additional obligations or liabilities arise from TI providing such TI Resources. TI reserves the right to make corrections, enhancements, improvements and other changes to its TI Resources. TI has not conducted any testing other than that specifically described in the published documentation for a particular TI Resource.

Designer is authorized to use, copy and modify any individual TI Resource only in connection with the development of applications that include the TI product(s) identified in such TI Resource. NO OTHER LICENSE, EXPRESS OR IMPLIED, BY ESTOPPEL OR OTHERWISE TO ANY OTHER TI INTELLECTUAL PROPERTY RIGHT, AND NO LICENSE TO ANY TECHNOLOGY OR INTELLECTUAL PROPERTY RIGHT OF TI OR ANY THIRD PARTY IS GRANTED HEREIN, including but not limited to any patent right, copyright, mask work right, or other intellectual property right relating to any combination, machine, or process in which TI products or services are used. Information regarding or referencing third-party products or services does not constitute a license to use such products or services, or a warranty or endorsement thereof. Use of TI Resources may require a license from a third party under the patents or other intellectual property of the third party, or a license from TI under the patents or other intellectual property of TI.

TI RESOURCES ARE PROVIDED "AS IS" AND WITH ALL FAULTS. TI DISCLAIMS ALL OTHER WARRANTIES OR REPRESENTATIONS, EXPRESS OR IMPLIED, REGARDING RESOURCES OR USE THEREOF, INCLUDING BUT NOT LIMITED TO ACCURACY OR COMPLETENESS, TITLE, ANY EPIDEMIC FAILURE WARRANTY AND ANY IMPLIED WARRANTIES OF MERCHANTABILITY, FITNESS FOR A PARTICULAR PURPOSE, AND NON-INFRINGEMENT OF ANY THIRD PARTY INTELLECTUAL PROPERTY RIGHTS. TI SHALL NOT BE LIABLE FOR AND SHALL NOT DEFEND OR INDEMNIFY DESIGNER AGAINST ANY CLAIM, INCLUDING BUT NOT LIMITED TO ANY INFRINGEMENT CLAIM THAT RELATES TO OR IS BASED ON ANY COMBINATION OF PRODUCTS EVEN IF DESCRIBED IN TI RESOURCES OR OTHERWISE. IN NO EVENT SHALL TI BE LIABLE FOR ANY ACTUAL, DIRECT, SPECIAL, COLLATERAL, INDIRECT, PUNITIVE, INCIDENTAL, CONSEQUENTIAL OR EXEMPLARY DAMAGES IN CONNECTION WITH OR ARISING OUT OF TI RESOURCES OR USE THEREOF, AND REGARDLESS OF WHETHER TI HAS BEEN ADVISED OF THE POSSIBILITY OF SUCH DAMAGES.

Unless TI has explicitly designated an individual product as meeting the requirements of a particular industry standard (e.g., ISO/TS 16949 and ISO 26262), TI is not responsible for any failure to meet such industry standard requirements.

Where TI specifically promotes products as facilitating functional safety or as compliant with industry functional safety standards, such products are intended to help enable customers to design and create their own applications that meet applicable functional safety standards and requirements. Using products in an application does not by itself establish any safety features in the application. Designers must ensure compliance with safety-related requirements and standards applicable to their applications. Designer may not use any TI products in life-critical medical equipment unless authorized officers of the parties have executed a special contract specifically governing such use. Life-critical medical equipment is medical equipment where failure of such equipment would cause serious bodily injury or death (e.g., life support, pacemakers, defibrillators, heart pumps, neurostimulators, and implantables). Such equipment includes, without limitation, all medical devices identified by the U.S. Food and Drug Administration as Class III devices and equivalent classifications outside the U.S.

TI may expressly designate certain products as completing a particular qualification (e.g., Q100, Military Grade, or Enhanced Product). Designers agree that it has the necessary expertise to select the product with the appropriate qualification designation for their applications and that proper product selection is at Designers' own risk. Designers are solely responsible for compliance with all legal and regulatory requirements in connection with such selection.

Designer will fully indemnify TI and its representatives against any damages, costs, losses, and/or liabilities arising out of Designer's non-compliance with the terms and provisions of this Notice.