



Ozone Gas Sensor
(Model: MQ131 Low Concentration)

Manual

Version: 1.6

Valid from: 2021-07-01

Zhengzhou Winsen Electronics Technology Co., Ltd

Statement

This manual copyright belongs to Zhengzhou Winsen Electronics Technology Co., LTD. Without the written permission, any part of this manual shall not be copied, translated, stored in database or retrieval system, also can't spread through electronic, copying, record ways.

Thanks for purchasing our product. In order to let customers use it better and reduce the faults caused by misuse, please read the manual carefully and operate it correctly in accordance with the instructions. If users disobey the terms or remove, disassemble, change the components inside of the sensor, we shall not be responsible for the loss.

The specific such as color, appearance, sizes &etc, please in kind prevail.

We are devoting ourselves to products development and technical innovation, so we reserve the right to improve the products without notice. Please confirm it is the valid version before using this manual. At the same time, users' comments on optimized using way are welcome.

Please keep the manual properly, in order to get help if you have questions during the usage in the future.

Zhengzhou Winsen Electronics Technology CO., LTD

MQ131 Ozone Gas Sensor (Low Concentration)

Profile

Sensitive material of MQ131 gas sensor is a semiconductor metal oxide with high conductivity in clean air. When the ozone gas exists, the sensor's conductivity gets lower along with the gas concentration rising. Users can convert the change of conductivity to correspond output signal of gas concentration through a simple circuit.

MQ131 ozone gas sensor has high sensitivity to ozone, and also has sensitivity to strong oxide gases, such as Cl₂, NO₂ etc. It responds oppositely to organic interference gases, compared with O₃.



Features

It has good sensitivity to ozone in wide range, and has advantages such as long lifespan, low cost and simple drive circuit &etc.

Main Applications

It is widely used in domestic ozone concentration alarm, industrial ozone concentration alarm and portable ozone concentration detector.

Technical Parameters

Stable.1

Model		MQ131	
Sensor Type		Semiconductor	
Standard Encapsulation		Plastic cap	
Target Gas		Ozone	
Detection range		10~1000ppb Ozone	
Standard Circuit Conditions	Loop Voltage	V _c	5.0V±0.1V DC
	Heater Voltage	V _H	5.0V±0.1V AC or DC
	Load Resistance	R _L	Adjustable
Sensor character under standard test conditions	Heater Resistance	R _H	35Ω±3Ω (room temp.)
	Heater consumption	P _H	≤800mW
	Sensitivity	S	Rs(in 200ppb O ₃)/Rs(in air)≥2
	Output Voltage	ΔVs	≥1.0V(in 200ppb O ₃)
	Concentration Slope	α	≤0.6(R _{100ppb} /R _{500ppb} O ₃)
Standard test conditions	Temp. Humidity	20℃±2℃; 55%±5%RH	
	Standard test circuit	V _c :5.0V±0.1V; V _H : 5.0V±0.1V	
	Preheat time	Over 48 hours	
Oxygen content	21% (not less than 18%, (oxygen concentration will affect the initial value, sensitivity and repeatability of the sensor, please consult when using it under low oxygen concentration)		
Life span	5 years		

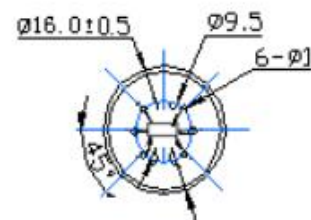
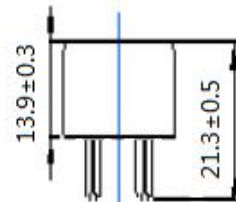
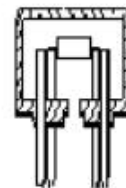

Unit of dimension: mm
Unmarked tolerance: ±0.1mm

NOTE: The change of Output voltage(ΔVs) is the difference value between V_{RL} in test environment and V_{RL} in clean air .

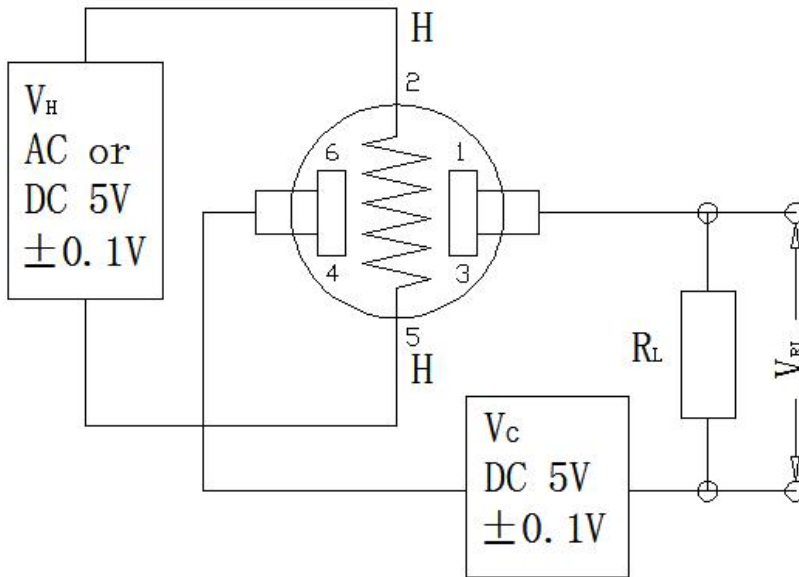
Basic Circuit**Fig2. MQ131 Test Circuit**

Instructions: The above fig is the basic test circuit of MQ131. The sensor requires two voltage inputs: heater voltage (V_H) and circuit voltage (V_C). V_H is used to supply standard working temperature to the sensor and it can adopt DC or AC power, while V_{RL} is the voltage of load resistance R_L which is in series with sensor. V_C supplies the detect voltage to load resistance R_L and it should adopt DC power.

Calculation formula: Resistance of Sensitive materials (R_s) = $(V_C/V_{RL} - 1) \times R_L$;

Power consumption of Sensitive materials (P_s) = $V_C^2 \times R_s / (R_s + R_L)^2$

Description of Sensor Characters

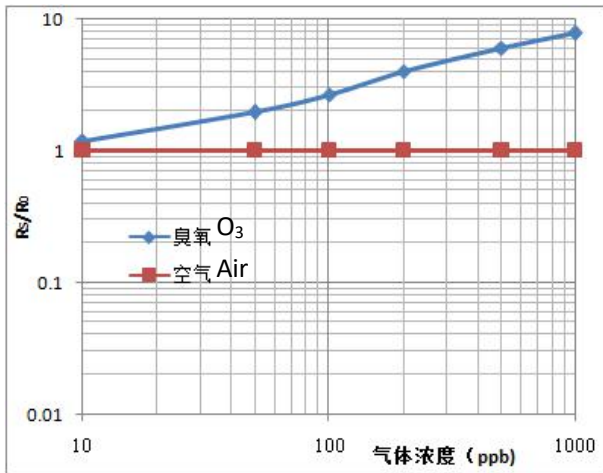

Fig3. Typical Sensitivity Curve

The ordinate is resistance ratio of the sensor (R_s/R_0), the abscissa is concentration of gases. R_s means resistance in target gas with different concentration, R_0 means resistance of sensor in clean air. All tests are finished under standard test conditions.

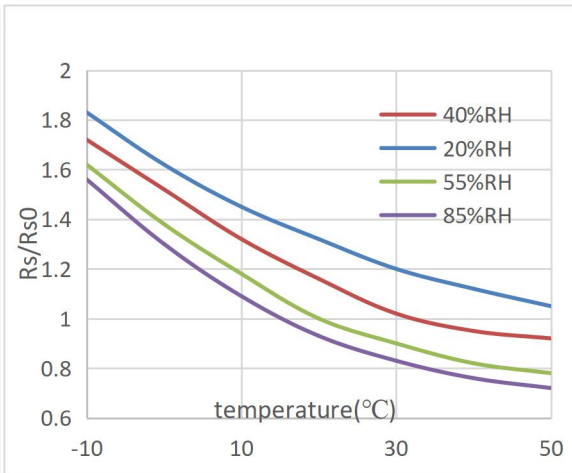

Fig4. Typical temperature/humidity characteristics

The ordinate is resistance ratio of the sensor (R_s/R_0). R_s means resistance of sensor in 200ppb O_3 gas under different tem. and humidity. R_{s0} means resistance of the sensor in 200ppb O_3 gas under 20°C/55%RH.

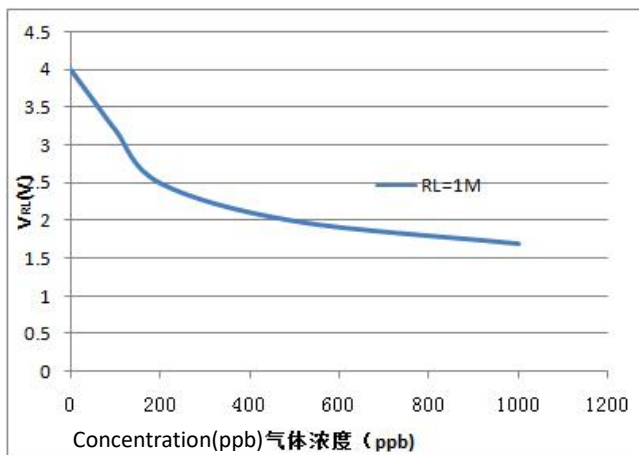

Fig5. Sensitivity Curve

Fig5 shows the V_{RL} in O_3 gas with different concentration. The resistance load R_L is 1 MΩ and the test is finished in standard test conditions.

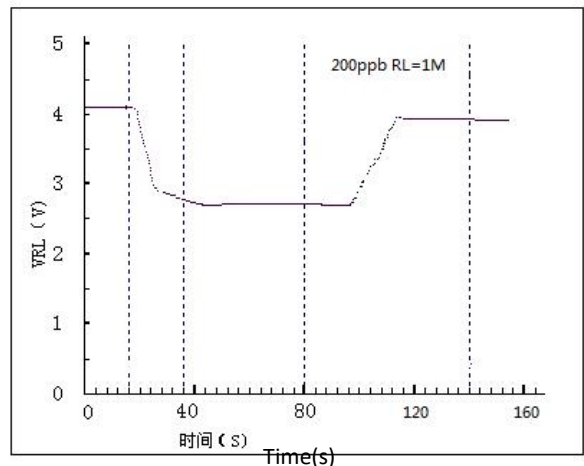

Fig6. Response and Resume

Fig5 shows the changing of V_{RL} in the process of putting the sensor into target gas and removing it out.

Cautions

1. Following conditions must be prohibited

1.1 Exposed to organic silicon steam

Sensing material will lose sensitivity and never recover if the sensor absorbs organic silicon steam. Sensors must avoid exposing to silicon bond, fixture, silicon latex, putty or plastic contain silicon environment.

1.2 High Corrosive gas

If the sensors are exposed to high concentration corrosive gas (such as H₂S, SO_x, Cl₂, HCl etc.), it will not only result in corrosion of sensors structure, also it cause sincere sensitivity attenuation.

1.3 Alkali, Alkali metals salt, halogen pollution

The sensors performance will be changed badly if sensors be sprayed polluted by alkali metals salt especially brine, or be exposed to halogen such as fluorine.

1.4 Touch water

Sensitivity of the sensors will be reduced when spattered or dipped in water.

1.5 Freezing

Do avoid icing on sensor's surface, otherwise sensing material will be broken and lost sensitivity.

1.6 Applied higher voltage

Applied voltage on sensor should not be higher than stipulated value, even if the sensor is not physically damaged or broken, it causes down-line or heater damaged, and bring on sensors' sensitivity characteristic changed badly.

1.7 Voltage on wrong pins

For 6 pins sensor, Pin 2&5 is heating electrodes, Pin (1,3)/(4,6) are testing electrodes (Pin 1 connects with Pin 3, while Pin 4 connects with Pin 6). If apply voltage on Pin 1&3 or 4&6, it will make lead broken; and no signal putout if apply on pins 2&4.

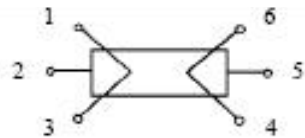

Fig7. Lead sketch

2 .Following conditions must be avoided

2.1 Water Condensation

Indoor conditions, slight water condensation will influence sensors' performance lightly. However, if water condensation on sensors surface and keep a certain period, sensors' sensitive will be decreased.

2.2 Used in high gas concentration

No matter the sensor is electrified or not, if it is placed in high gas concentration for long time, sensors characteristic will be affected. If lighter gas sprays the sensor, it will cause extremely damage.

2.3 Long time storage

The sensors resistance will drift reversibly if it's stored for long time without electrify, this drift is related with storage conditions. Sensors should be stored in airproof bag without volatile silicon compound. For the sensors with long time storage but no electrify, they need long aging time for stability before using. The suggested aging time as follow:

Stable2.

Storage Time	Suggested aging time
Less than one month	No less than 48 hours
1 ~ 6 months	No less than 72 hours
More than six months	No less than 168 hours

2.4 Long time exposed to adverse environment

No matter the sensors electrified or not, if exposed to adverse environment for long time, such as high humidity, high temperature, or high pollution etc., it will influence the sensors' performance badly.

2.5 Vibration

Continual vibration will result in sensors down-lead response then break. In transportation or

assembling line, pneumatic screwdriver/ultrasonic welding machine can lead this vibration.

2.6 Concussion

If sensors meet strong concussion, it may lead its lead wire disconnected.

2.7 Usage Conditions

2.7.1 For sensor, handmade welding is optimal way. The welding conditions as follow:

- Soldering flux: Lead-free and halogen-free flux
- homothermal soldering iron
- Temperature: $\leq 350^{\circ}\text{C}$
- Time: no more than 3 seconds

If disobey the above using terms, sensors sensitivity will reduce.

Zhengzhou Winsen Electronics Technology Co., Ltd

Add: No.299, Jinsuo Road, National Hi-Tech Zone,
Zhengzhou 450001 China

Tel: +86-371-67169097/67169670

Fax: +86-371-60932988

E-mail: sales@winsensor.com

Website: www.winsen-sensor.com