

## CM-26

尾部拔盖式快接端子

材料: PA/PC

五金件: 铜

电流电压: 32A 600V T105 / 32A 450V T85

阻燃等级: UL 94V-0 / UL 94V-2

适配电线: 24-12AWG / 0.2-4.0mm<sup>2</sup>

获得认证:

Patent: 201830671856.0

201930045409.9

Fast connector

housing: PA/PC

contact: nickel plated brass

ratings: 32A 600V T105 / 32A 450V T85

Category to heat and fire: UL 94V-0 / UL 94V-2

Wiring capacity: 24-12AWG / 0.2-4.0mm<sup>2</sup>

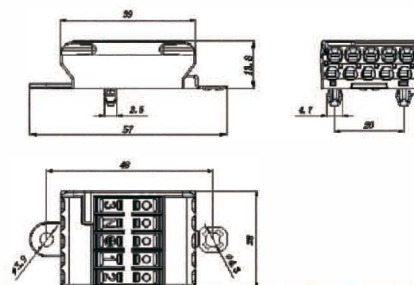

## CM-275

双层多进多出连接器-5位

材料: PA

五金件: 铜

电流电压: UL: 24A 450V T110°C

阻燃等级: UL 94V-0/UL 94V-2

适配电线: 上层插线孔: 0.5-2.5mm<sup>2</sup>

下层插线孔: 0.5-2.5mm<sup>2</sup>

获得认证:

Patent: 201921342345.X

multi-in and multi out connector-5 pin

housing: PA/PC

contact: nickel plated brass

ratings: UL: 24A 450V T110°C

Category to heat and fire: UL 94V-0/UL 94V-2

Wiring capacity: 0.5-2.5mm<sup>2</sup>



## CM-28

材料: PA+PC环保阻燃

五金件: 铜+不锈钢

电流/电压: 15A/600V AC T105°C

阻燃等级: UL94-VO

适配电线: 20AWG-12AWG/0.5-4.0mm<sup>2</sup>

获得认证:

Patent: 201920433015.5

201930020715.7

Fast connector

housing: PA/PC

contact: nickel plated brass

ratings: 15A 600V T105 / 15A 450V T85

Category to heat and fire: UL 94V-0 / UL 94V-2

Wiring capacity: 20-12AWG / 0.5-4.0mm<sup>2</sup>

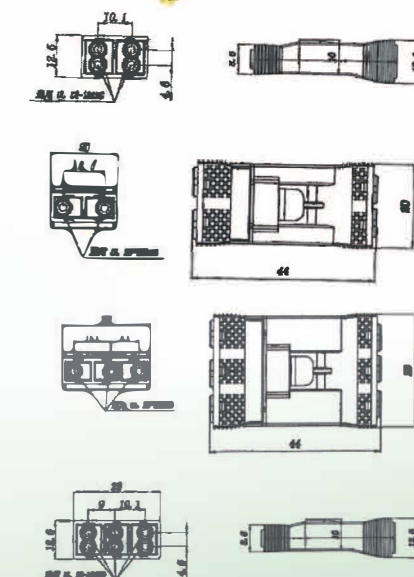

## CM-626/636

两进四出对插连接器/三进六出对插连接器

材料: PA

五金件: 磷铜

电流电压: UL: 6A 600VAC

KEMA/ENEC:450V T105°C

阻燃等级: UL 94V-0

适配电线: 2孔: 12-18AWG 或0.75-4.0mm<sup>2</sup>

4孔: 12-18AWG 或0.75-4.0mm<sup>2</sup>

3孔: 12-18AWG 或0.75-4.0mm<sup>2</sup>

6孔: 12-18AWG 或0.75-4.0mm<sup>2</sup>

获得认证:

USA Patent: US D866475 S

201830077680.6 201830077673.6

2 in 4 out male-female connector/3 in 6 out male-female connector

housing: PA

contact: nickel plated copper

ratings: UL: 6A 600VAC KEMA/ENEC:450V T105°C

Category to heat and fire: UL 94V-0

Wiring capacity: 3 in: 12-18AWG / 0.75-4.0mm<sup>2</sup>

6 out: 12-18AWG / 0.75-4.0mm<sup>2</sup>



APPLICATION NUMBER  
29/665,798



## M29/M29mini

名称: 路灯断电保护连接器  
 外壳: PA, 环保阻燃  
 五金件: 环保铜 镀镍  
 电流电压: 16A, 450V, T110°C  
 阻燃等级: 灼热丝试验850°C/UL94-V0  
 适配线材: 0.75-2.5mm<sup>2</sup>; 12AWG-20AWG

获得认证: E481743

Patent: 201730186634.5

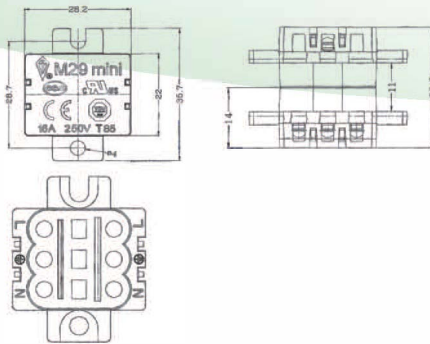

Street Light Connector  
 Housing: PA, comply with RoHS, PAHs, SVHC  
 Insert: nickel plated brass;  
 Ratings: 16A, 450V, T110°C  
 Category to heat and fire: glow wire test 850 degrees Celsius/UL94-V0  
 Wiring Capacity: 0.75-2.5mm<sup>2</sup>; 12AWG-20AWG



## CM-6019

按压式多芯对插连接器;  
 材料: PC+PA, 环保阻燃;  
 五金件: 环保铜+不锈钢镀镍;  
 参数: 16A, 450V, -10°C to 135°C;  
 阻燃等级: 灼热丝试验850°C;  
 适配电线: 0.5-1.5mm<sup>2</sup>;

获得认证:

Patent: 201720370257.5  
 201730155711.0

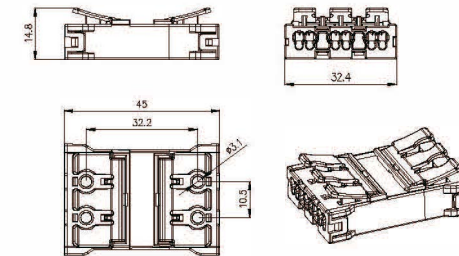

Push wire multi-core male-female Connector  
 Housing: PC+PA, fire resistant.  
 Contact: Nickel plated brass  
 Ratings: 16A, 450V, -10°C to 135°C;  
 Category to heat and fire: glow wire test 850°C;  
 Wiring capacity: 0.5-1.5mm<sup>2</sup>;

## 型号: M29加长

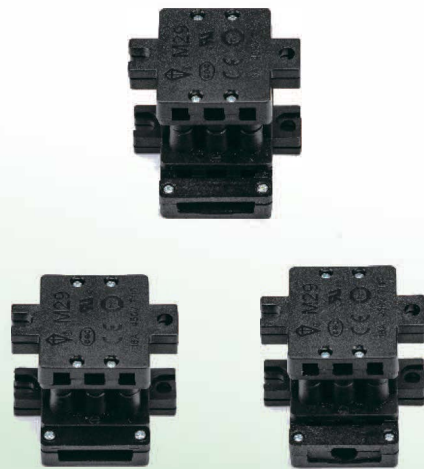

名称: 路灯断电保护连接器  
 外壳: PA, 环保阻燃  
 五金件: 环保铜 镀镍  
 电流电压: 16A, 450V, T110°C  
 阻燃等级: 灼热丝试验850°C/UL94-V0  
 适配线材: 0.75-2.5mm<sup>2</sup>; 12AWG-20AWG

获得认证: E481743

Patent: 201730186634.5

Street Light Connector  
 Housing: PA, comply with RoHS, PAHs, SVHC  
 Insert: nickel plated brass;  
 Ratings: 16A, 450V, T110°C  
 Category to heat and fire: glow wire test 850 degrees Celsius/UL94-V0  
 Wiring Capacity: 0.75-2.5mm<sup>2</sup>; 12AWG-20AWG



## CM-252/253/254/255

平插端子: 二位、三位、四位、五位  
 材料: PC, 环保阻燃  
 五金件: 环保铜  
 电流/电压: UL: MAX24A, 300V, T105°C  
 ENEC: MAX24A, 450V, T110°C  
 阻燃等级: 灼热丝试验850°C  
 配线规格: 0.5-2.5单股硬导线/1.5-2.5多股硬导线  
 14AWG-20AWG

获得认证:

Patent: 201720849082.6

Item No.: connector 2/3/5 ways  
 Applications: applicable to lighting products and other electrical products  
 Housing: PC, comply with RoHS, PAHs, SVHC  
 Insert: nickel plated brass;  
 Ratings: UL: MAX24A, 300V, T105°C  
 ENEC: MAX24A, 450V, T110°C  
 Category to heat and fire: glow wire test 850 degrees Celsius  
 Wiring Capacity: 0.5-2.5mm<sup>2</sup> rigid wire/1.5-2.5mm<sup>2</sup> soldering wire  
 14AWG-20AWG

NEW

超薄



## CM-8621

mini无螺纹接线端子——两位/三位;  
 材料: PC+PA或PC+PP, 环保阻燃;  
 五金件: 环保铜+不锈钢镀镍;  
 参数: 17.5A, 450V, T110℃或T185℃;  
 阻燃等级: 灼热丝试验850℃;  
 适配电线: 0.5-1.5mm<sup>2</sup>;

获得认证:

Patent: 201720609714.1

Mini push wire connector 2/3 ways  
 Housing: PC+PA/PC+PP, fire resistant.  
 Contact: Nickel plated brass  
 Ratings: 17.5A, 450V, T110℃/T85℃;  
 Category to heat and fire: glow wire test 850℃;  
 Wiring capacity: 0.5-1.5mm<sup>2</sup>;

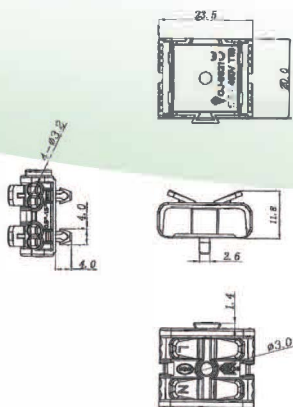

NEW

超薄



## CM-8631

mini无螺纹接线端子——两位/三位;  
 材料: PC+PA或PC+PP, 环保阻燃;  
 五金件: 环保铜+不锈钢镀镍;  
 参数: 17.5A, 450V, T110℃或T185℃;  
 阻燃等级: 灼热丝试验850℃;  
 适配电线: 0.5-1.5mm<sup>2</sup>;

获得认证:

Patent: 201720609714.1

Mini push wire connector 2/3 ways  
 Housing: PC+PA/PC+PP, fire resistant.  
 Contact: Nickel plated brass  
 Ratings: 17.5A, 450V, T110℃/T85℃;  
 Category to heat and fire: glow wire test 850℃;  
 Wiring capacity: 0.5-1.5mm<sup>2</sup>;

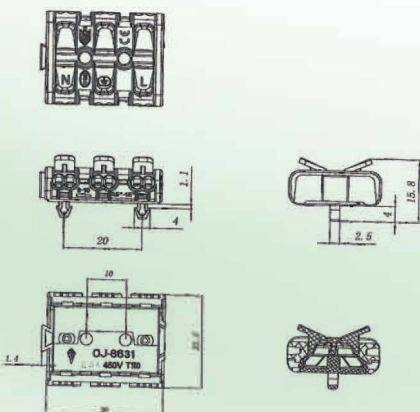

## CM-862/CM-863

插拔式弹簧连接器  
 材料: PC/PA, 环保阻燃  
 五金件: 环保铜 镀镍; 电流/电压: 6A-24A, 450V, T110℃  
 阻燃等级: 灼热丝试验850℃  
 适配电线: 0.5mm<sup>2</sup>; 0.75-2.5mm<sup>2</sup>

获得认证:

Patent: 201430068949.6  
201420140238.X

Item No.: pushwire connector 2/3 ways  
 Applications: applicable to lighting products and other electrical products  
 Housing: PC/PA, comply with RoHS, PAHs, SVHC  
 Insert: nickel plated brass; Ratings: 6A-24A, 450V, T110℃  
 Category to heat and fire: glow wire test 850 degrees Celsius  
 Wiring Capacity: 0.5mm<sup>2</sup>; 0.75-2.5mm<sup>2</sup>

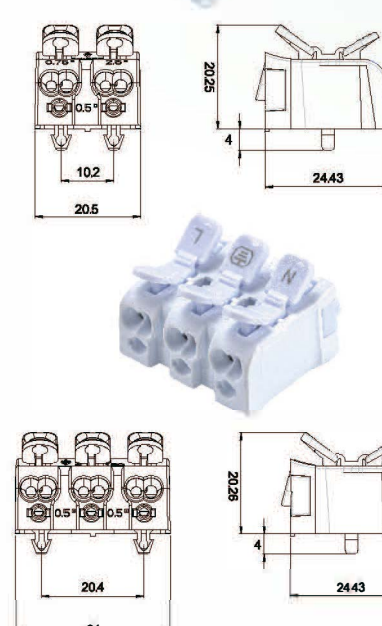

## CM-864/CM-865

插拔式弹簧连接器  
 材料: PC/PA, 环保阻燃  
 五金件: 环保铜 镀镍; 电流/电压: 6A-24A, 450V, T110℃  
 阻燃等级: 灼热丝试验850℃  
 适配电线: 0.5mm<sup>2</sup>; 0.75-2.5mm<sup>2</sup>

获得认证:

Patent: 201430068949.6  
201420140238.X

Item No.: pushwire connector 4/5 ways  
 Applications: applicable to lighting products and other electrical products  
 Housing: PC/PA, comply with RoHS, PAHs, SVHC  
 Insert: nickel plated brass; Ratings: 6A-24A, 450V, T110℃  
 Category to heat and fire: glow wire test 850 degrees Celsius  
 Wiring Capacity: 0.5mm<sup>2</sup>; 0.75-2.5mm<sup>2</sup>

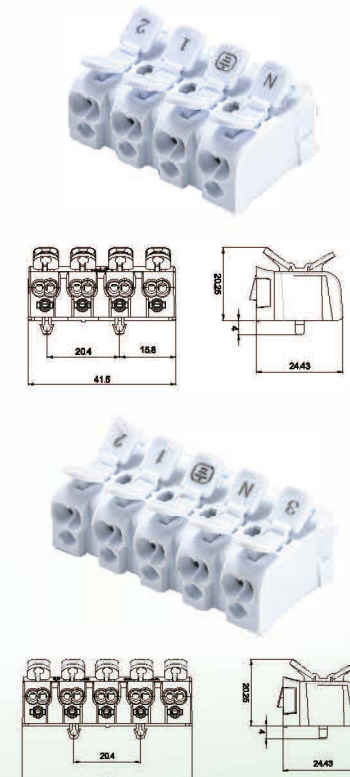



## CM-821/CM-831

插拔式弹簧连接器

材料: PC/PA, PP/PC,环保阻燃

五金件: 环保铜 镀镍;

电流/电压: 6A-24A, 450V, 15A 300V, T110°C/T85°C

阻燃等级: 灼热丝试验850°C

适配电线: 0.5mm<sup>2</sup>; 0.75-2.5mm<sup>2</sup>; 14AWG-20AWG

获得认证:

Patent: 201430068949.6  
201420140238.X

Item No.: pushwire connector 2 /3 ways

Applications: applicable to lighting products and other electrical products

Housing: PC/PA, comply with RoHS, PAHs, SVHC

Insert: nickel plated brass;

Ratings: 6A-24A, 450V, 15A 300V, T110°C/T85°C

Category to heat and fire: glow wire test 850 degrees Celsius

Wiring Capacity: 0.5mm<sup>2</sup>; 0.75-2.5mm<sup>2</sup>; 14AWG-20AWG

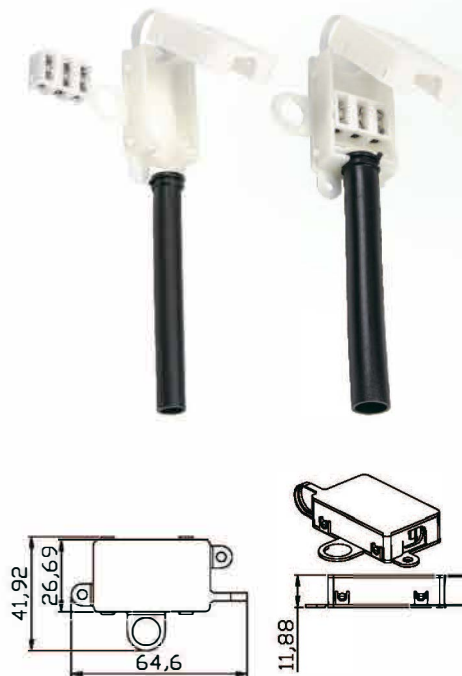

## CM-3318

三位接线盒

材料: 外壳PA/PP料, 环保阻燃

五金件: 环保铜 镀镍;

电流/电压: 17.5A, 250V; T100°C或T85°C

阻燃等级: 灼热丝试验850°C

适配电线: 0.75mm<sup>2</sup>-1.5mm<sup>2</sup>

获得认证:

Patent: 201620461841.7

Item No.: OJ-3318 junction box 3 ways

Applications: applicable to lighting products and other electrical products

Housing: PA/PP, comply with RoHS, PAHs, SVHC

Insert: nickel plated brass;

Ratings: 17.5A, 250V; T100°C/T85°C

Category to heat and fire: glow wire test 850 degrees Celsius

Wiring Capacity: 0.75mm<sup>2</sup>-1.5mm<sup>2</sup>

## CM-841/CM-851

插拔式弹簧连接器

材料: PC/PA, PP/PC, 环保阻燃

五金件: 环保铜 镀镍;

电流/电压: 6A-24A, 450V, 15A, 300V, T110°C/T85°C

阻燃等级: 灼热丝试验850°C

适配电线: 0.5mm<sup>2</sup>; 0.75-2.5mm<sup>2</sup>; 14AWG-20AWG

获得认证:

Patent: 201430068949.6  
201420140238.X

Item No.: pushwire connector 4/5 ways

Applications: applicable to lighting products and other electrical products

Housing: PC/PA, PP/PC, comply with RoHS, PAHs, SVHC

Insert: nickel plated brass;

Ratings: 6A-24A, 450V, 15A, 300V, T110°C/T85°C

Category to heat and fire: glow wire test 850 degrees Celsius

Wiring Capacity: 0.5mm<sup>2</sup>; 0.75-2.5mm<sup>2</sup>; 14AWG-20AWG

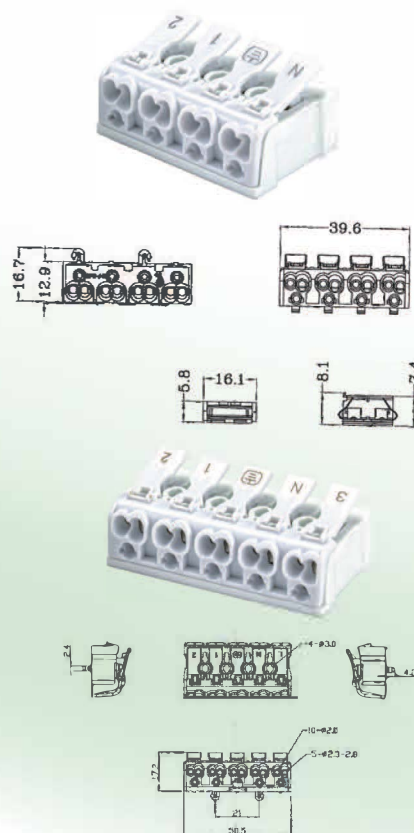

## CM-3218

两位接线盒

材料: 外壳PA/PP料, 环保阻燃

五金件: 环保铜 镀镍;

电流/电压: 17.5A, 250V; T100°C或T85°C

阻燃等级: 灼热丝试验850°C

适配电线: 0.75mm<sup>2</sup>-1.5mm<sup>2</sup>

获得认证:

Patent: 201620461841.7

Item No.: OJ-3218 junction box 2 ways

Applications: applicable to lighting products and other electrical products

Housing: PA/PP, comply with RoHS, PAHs, SVHC

Insert: nickel plated brass;

Ratings: 17.5A, 250V; T100°C/T85°C

Category to heat and fire: glow wire test 850 degrees Celsius

Wiring Capacity: 0.75mm<sup>2</sup>-1.5mm<sup>2</sup>



## CM-3319

**Ip44 防水接线盒**  
 材料: 外壳PA/PP料, 环保阻燃  
 五金件: 环保铜 镀镍;  
 电流/电压: 17.5A ,250V~; T100℃或T85℃  
 阻燃等级: 灼热丝试验850℃  
 适配电线: 0.75mm<sup>2</sup>-1.5mm<sup>2</sup>

获得认证:   

Patent: 201330480060.4

Item No.: OJ-3319 IP44 rated junction box

Applications: applicable to lighting products and other electrical products  
 Housing: PA, comply with RoHS, PAHs, SVHC  
 Insert: nickel plated brass;

Ratings: 17.5A ,250V~; T100℃/T85℃  
 Category to heat and fire: glow wire test 850 degrees Celsius

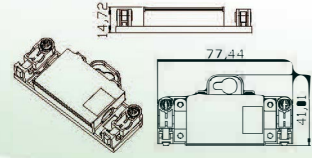

## CM-3518

**Ip44 防水接线盒**

材料: 外壳PA, 环保阻燃

五金等级环保铜 镀镍; 电流/电压: 17.5A ,250V~

适配电线: 0.75mm<sup>2</sup>-1.5mm<sup>2</sup>

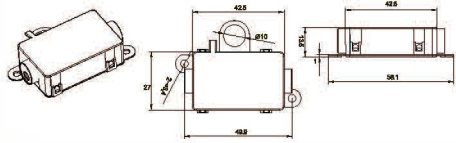

获得认证:   

Item No.: OJ-3518 IP44 rated junction box  
 Applications: applicable to lighting products and other electrical products  
 Housing: PA, comply with RoHS, PAHs, SVHC  
 Insert: nickel plated brass; Ratings: 17.5A ,250V~  
 Category to heat and fire: glow wire test 850 degrees Celsius  
 Wiring Capacity: 0.75mm<sup>2</sup>-1.5mm<sup>2</sup>



## CM-3618

**Ip54 防水接线盒**  
 材料: 外壳PA, 环保阻燃  
 五金件: 环保铜 镀镍; 电流/电压: 17.5A ,250V~  
 阻燃等级: 灼热丝试验850℃  
 适配电线: 0.75mm<sup>2</sup>-1.5mm<sup>2</sup>

获得认证:   

Item No.: OJ-3618 IP54 rated junction box  
 Applications: applicable to lighting products and other electrical products  
 Housing: PA, comply with RoHS, PAHs, SVHC  
 Insert: nickel plated brass; Ratings: 17.5A ,250V~  
 Category to heat and fire: glow wire test 850 degrees Celsius  
 Wiring Capacity: 0.75mm<sup>2</sup>-1.5mm<sup>2</sup>

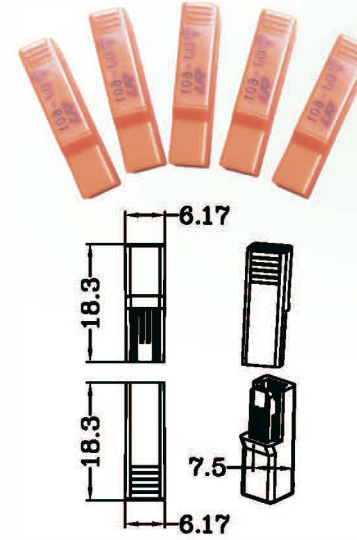
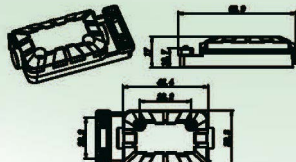

## CM-601

**Dc快接端子**  
 材料: PC 环保阻燃  
 五金件: 磷铜  
 电流/电压: 3A 36V DC T80℃  
 阻燃等级: UL94V-2  
 适配电线: UL 20AWG-22AWG 0.2mm<sup>2</sup> 0.5mm<sup>2</sup> 0.75mm<sup>2</sup>

获得认证:   E474196 

Patent: 201530077497.2  
 201520221100.7

Item No.: OJ-601  
 DC quick connector  
 Material: PC, comply with RoHS, PAHs, SVHC  
 Insert: Phosphorized-copper  
 Ratings: 3A 36V DC T80℃  
 Category to heat and fire: UL94V-2  
 Wiring capacity:  
 UL 20AWG-22AWG 0.2mm<sup>2</sup> 0.5mm<sup>2</sup> 0.75mm<sup>2</sup>

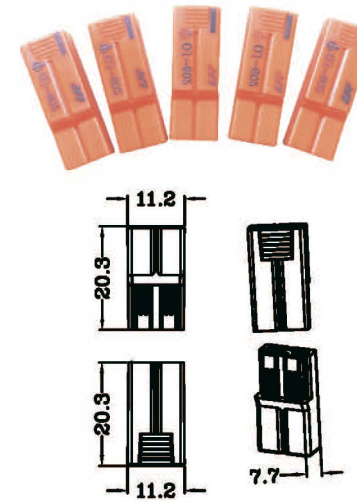

## CM-602

**Dc快接端子**  
 材料: PC 环保阻燃  
 五金件: 磷铜  
 电流/电压: 3A 36V DC T80℃  
 阻燃等级: UL94V-2  
 适配电线: UL 20AWG-22AWG 0.2mm<sup>2</sup> 0.5mm<sup>2</sup> 0.75mm<sup>2</sup>

获得认证:   E474196 

Patent: 201530077499.1  
 201520221100.7

Item No.: OJ-602  
 DC quick connector  
 Material: PC, comply with RoHS, PAHs, SVHC  
 Insert: Phosphorized-copper  
 Ratings: 3A 36V DC T80℃  
 Category to heat and fire: UL94V-2  
 Wiring capacity:  
 UL 20AWG-22AWG 0.2mm<sup>2</sup> 0.5mm<sup>2</sup> 0.75mm<sup>2</sup>

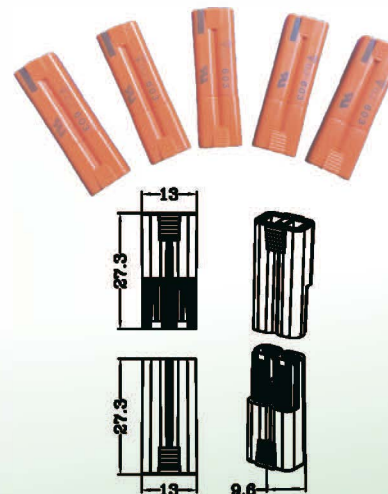

## CM-603

**Ac快接端子**  
 材料: PC 环保阻燃  
 五金件: 磷铜  
 电流/电压: 10A 250V AC / 10A 125V AC T80℃  
 阻燃等级: UL94V-2  
 适配电线: UL 16-18AWG 0.75mm<sup>2</sup>-1.0mm<sup>2</sup>

获得认证:   E474196 

Patent: 201530077498.7  
 201520221100.7

Item No.: OJ-603  
 AC quick connector  
 Material: PC, comply with RoHS, PAHs, SVHC  
 Insert: plated phosphorized-copper  
 Ratings: 10A 250V AC / 10A 125V AC T80℃  
 Category to heat and fire: UL94V-2  
 Wiring capacity:  
 UL 16-18AWG 0.75mm<sup>2</sup>-1.0mm<sup>2</sup>



## CM-616

快接端子  
 材料: PA 环保阻燃  
 五金件: 磷铜  
 电流/电压: 6A 125V T80°C或T125°C  
 阻燃等级: UL94-V0/UL94V-2  
 适配电线: 18-22 AWG

获得认证: E474196

Patent: 201520778278.1

Item No.: OJ-606  
 quick connector  
 Material: PC, comply with RoHS, PAHs, SVHC  
 Insert: plated phosphorized-copper  
 Ratings: 6A 125V T80°C/T125°C  
 Category to heat and fire: UL94V-2  
 Wiring capacity: 18-22 AWG

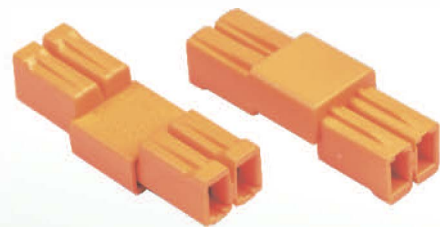
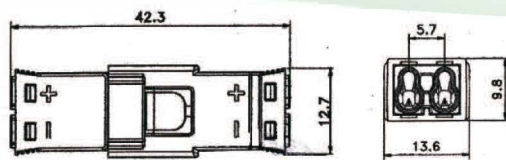

## CM-606

快接端子  
 材料: PA 环保阻燃  
 五金件: 磷铜  
 电流/电压: 6A 125V T80°C或T125°C  
 阻燃等级: UL94-V0/UL94V-2  
 适配电线: 18-22 AWG

获得认证: E474196

Patent: 201520778278.1

Item No.: OJ-606  
 quick connector  
 Material: PC, comply with RoHS, PAHs, SVHC  
 Insert: plated phosphorized-copper  
 Ratings: 6A 125V T80°C/T125°C  
 Category to heat and fire: UL94V-2  
 Wiring capacity: 18-22 AWG

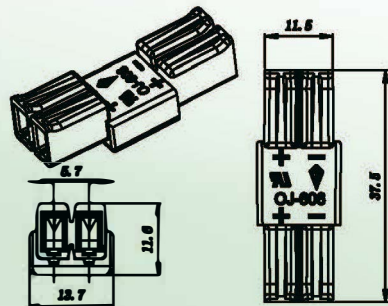

## CM-609

UL筒灯转接头  
 600V 660W T125°C  
 1015 18AWG E490793

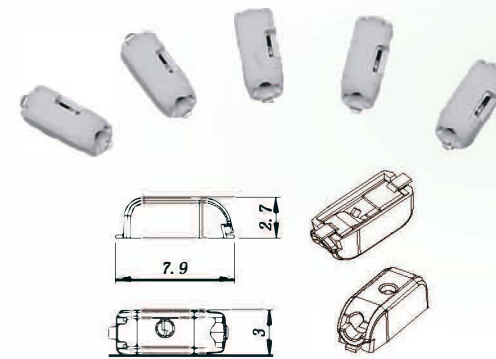

## CM-2058-1

SMD贴片端子  
 外壳: 高温尼龙  
 五金件: 高精磷铜  
 参数: 3A 300V  
 适配电线: 20AWG-22AWG

SMD terminal  
 Housing: PA  
 Conductor: phosphor copper  
 Ratings: UL: 300V 3A  
 Wiring: 20AWG-22AWG

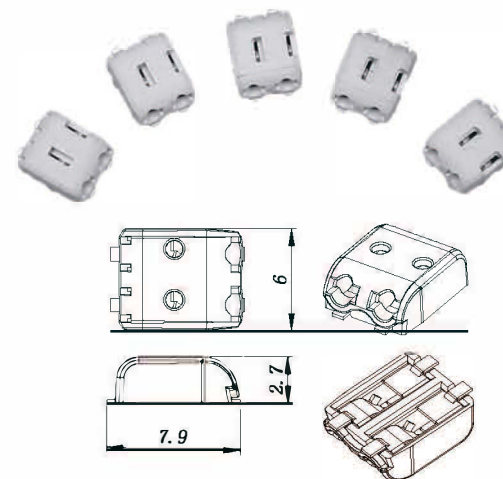

## CM-2058-2

SMD贴片端子  
 外壳: 高温尼龙  
 五金件: 高精磷铜  
 参数: 3A 300V  
 适配电线: 20AWG-22AWG

SMD terminal  
 Housing: PA  
 Conductor: phosphor copper  
 Ratings: UL: 300V 3A  
 Wiring: 20AWG-22AWG

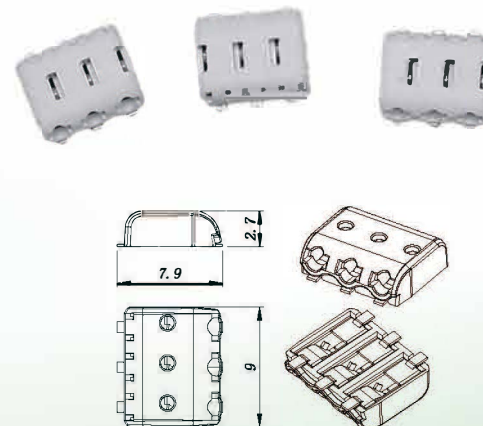
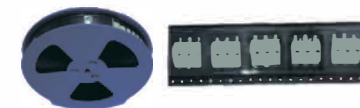

## CM-2058-3

SMD贴片端子  
 外壳: 高温尼龙  
 五金件: 高精磷铜  
 参数: 3A 300V  
 适配电线: 20AWG-22AWG

SMD terminal  
 Housing: PA  
 Conductor: phosphor copper  
 Ratings: UL: 300V 3A  
 Wiring: 20AWG-22AWG



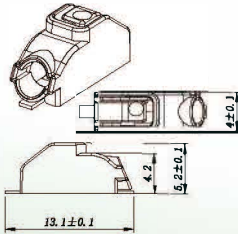

## CM-2068-1

SMD贴片端子  
 外壳: 高温尼龙 PA  
 五金件: 高精磷铜  
 参数: UL:6A 300V T65℃  
 TUV:6A 160V~ T110℃  
 适配电线: 0.2-0.75mm2  
 18-24AWG  
 获得认证: E481743  
 SMD terminal  
 Housing: PA46  
 Conductor:phosphor copper  
 Ratings: UL:6A 300V T65℃  
 TUV:6A 160V~ T110℃  
 Wiring: 0.2-0.75mm2 18-24AWG  
 Patent: **ZL201620263946.1**



## CM20-1

SMD贴片端子  
 外壳: 高温尼龙 PA  
 五金件: 高精磷铜  
 参数: UL:6A 300V T65℃  
 TUV:6A 160V~ T110℃  
 适配电线: 0.2-0.75mm2  
 18-24AWG  
 获得认证: E481743  
 SMD terminal  
 Housing: PA46  
 Conductor:phosphor copper  
 Ratings: UL:6A 300V T65℃  
 TUV:6A 160V~ T110℃  
 Wiring: 0.2-0.75mm2 18-24AWG  
 Patent: **ZL201620263946.1**

## CM-2068-2

SMD贴片端子  
 外壳: 高温尼龙 PA  
 五金件: 高精磷铜  
 参数: UL:6A 300V T65℃  
 TUV:6A 160V~ T110℃  
 适配电线: 0.2-0.75mm2  
 18-24AWG  
 获得认证: E481743  
 SMD terminal  
 Housing: PA46  
 Conductor:phosphor copper  
 Ratings: UL:6A 300V T65℃  
 TUV:6A 160V~ T110℃  
 Wiring: 0.2-0.75mm2 18-24AWG  
 Patent: **ZL201620263946.1**

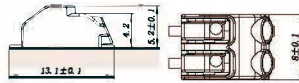
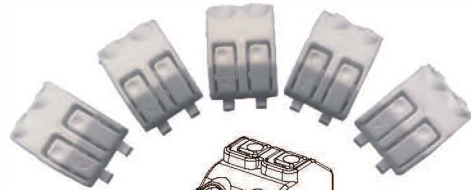

## CM20-2

SMD贴片端子  
 外壳: 高温尼龙 PA  
 五金件: 高精磷铜  
 参数: UL:6A 300V T65℃  
 TUV:6A 160V~ T110℃  
 适配电线: 0.2-0.75mm2  
 18-24AWG  
 获得认证: E481743  
 SMD terminal  
 Housing: PA46  
 Conductor:phosphor copper  
 Ratings: UL:6A 300V T65℃  
 TUV:6A 160V~ T110℃  
 Wiring: 0.2-0.75mm2 18-24AWG  
 Patent: **ZL201620263946.1**

## CM-2068-3

SMD贴片端子  
 外壳: 高温尼龙 PA  
 五金件: 高精磷铜  
 参数: UL:6A 300V T65℃  
 TUV:6A 160V~ T110℃  
 适配电线: 0.2-0.75mm2  
 18-24AWG  
 获得认证: E481743  
 SMD terminal  
 Housing: PA46  
 Conductor:phosphor copper  
 Ratings: UL:6A 300V T65℃  
 TUV:6A 160V~ T110℃  
 Wiring: 0.2-0.75mm2 18-24AWG  
 Patent: **ZL201620263946.1**

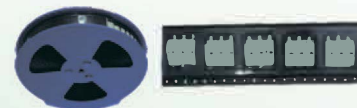
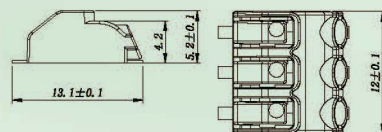

## CM20-3

SMD贴片端子  
 外壳: 高温尼龙 PA  
 五金件: 高精磷铜  
 参数: UL:6A 300V T65℃  
 TUV:6A 160V~ T110℃  
 适配电线: 0.2-0.75mm2  
 18-24AWG  
 获得认证: E481743  
 SMD terminal  
 Housing: PA46  
 Conductor:phosphor copper  
 Ratings: UL:6A 300V T65℃  
 TUV:6A 160V~ T110℃  
 Wiring: 0.2-0.75mm2 18-24AWG  
 Patent: **ZL201620263946.1**

## CM-607



两位大电流对插  
外壳: PC 环保阻燃  
五金件: 环保铜  
电流电压: 16A 250V T85°C  
适配电线: 0.75-1.5mm<sup>2</sup>

获得认证:

high current connector-2 poles  
Housing: fire-resistant PC  
Conductor: brass  
Ratings: 16A 250V T85°C  
Wiring: 0.75-1.5mm<sup>2</sup>  
Patent: **ZL201620263946.0**

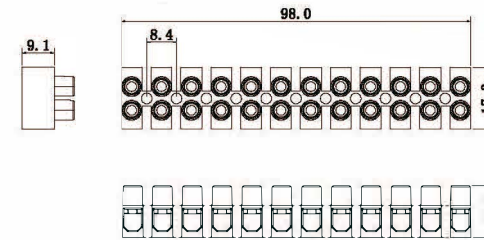
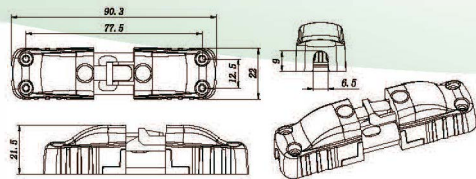

## CM-PA7-1~12

材质: 高级尼龙66

线缆塑胶A底部加高1.2mm  
额定电流电压: 17.5A/450V T110°C/T85°C  
尺寸: 96.7\*17.2\*14.4mm

防火等级: 94V-0或灼热丝试验850°C

获得认证:

Housing: Nylon 66,  
H type, with 1.2mm  
elevated base Wiring: MAX 1.5mm<sup>2</sup>  
Rated Current/Voltage: 17.5A/450V T110°C/T85°C  
Size: 96.7\*17.2\*14.4mm  
Category to heat and fire: 850°C



## CM-608



三位大电流对插  
外壳: PC 环保阻燃  
五金件: 环保铜  
电流电压: 16A 250V T85°C  
适配电线: 0.75-1.5mm<sup>2</sup>

获得认证:

high current connector-3 poles  
Housing: fire-resistant PC  
Conductor: brass  
Ratings: 16A 250V T85°C  
Wiring: 0.75-1.5mm<sup>2</sup>  
Patent: **ZL201620263946.0**

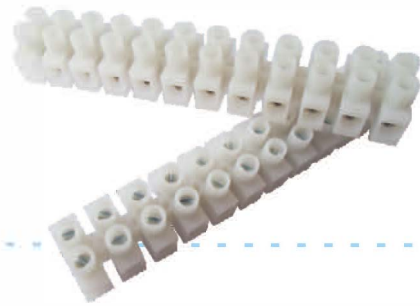
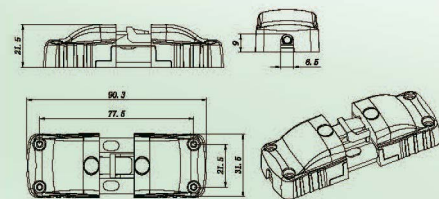

## CM-PA9-1~12

材质: 高级尼龙66

线缆塑胶A底部加高1.2mm  
额定电流电压: 24A/450V T110°C/T85°C  
尺寸: 118.2\*20.2\*16.3mm

防火等级: 94V-0或灼热丝试验850°C

获得认证:

Housing: Nylon 66,  
H type, with 1.2mm  
elevated base Wiring: MAX 2.5mm<sup>2</sup>  
Rated Current/Voltage: 24A/450V T110°C/T85°C  
Size: 118.2\*20.2\*16.3mm  
Category to heat and fire: 850°C



## CM-PA12-1~12

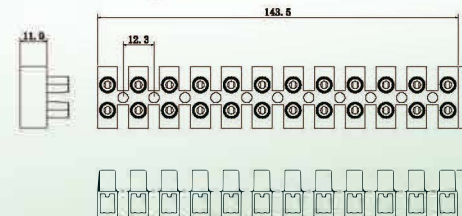

材质: 高级尼龙66

工程塑胶, 底部加高1.2mm  
线缆: MAX 6.0mm<sup>2</sup>  
额定电流电压: 41A/500V T110°C/T85°C  
尺寸: 141.8\*24.3\*19.1mm  
防火等级: 94V-0或灼热丝试验850°C

获得认证:

Housing: Nylon 66, H type, with 1.2mm  
elevated base Wiring: MAX 6.0mm<sup>2</sup>  
Rated Current/Voltage: 41A/500V T110°C/T85°C  
Size: 141.8\*24.3\*19.1mm  
Category to heat and fire: 850°C





NEW



### CM-5618

mini一进一出防水盒;  
材料: PC, 环保阻燃;  
参数: 17.5A, 450V, T85°C;  
阻燃等级: 灼热丝试验850°C;  
接线范围: 4-8mm;  
适配电线: Max 1.5mm<sup>2</sup>;  
防护等级: IP67;  
适配端子台: OJ-831、OJ-863、OJ-8631、OJ-PA9-3;

获得认证:

Mini 1 in and 1 out waterproof box  
Housing: PC, fire resistant;  
Ratings: 17.5A, 450V, T85°C;  
Category to heat and fire: glow wire test 850°C;  
Wire outer diameter: 4-8mm;  
Wiring capacity: Max 1.5mm<sup>2</sup>;  
IP rated: IP67;  
Applicable connector inside:  
OJ-831、OJ-863、OJ-8631、  
OJ-PA9-3;

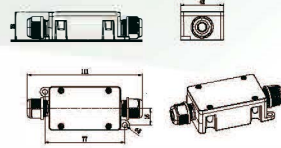

NEW



### CM-5718-A

一进一出防水接线盒;  
材料: PA, 环保阻燃;  
参数: 17.5A, 450V, T85°C;  
阻燃等级: 灼热丝试验850°C;  
接线范围: 4-8mm;  
适配电线: Max 1.5mm<sup>2</sup>;  
防护等级: IP65;  
适配端子台: OJ-831、OJ-863、OJ-8631、OJ-PA9-3;

获得认证:

1 in and 1 out waterproof box  
Housing: PA, fire resistant;  
Ratings: 17.5A, 450V, T85°C;  
Category to heat and fire: glow wire test 850°C;  
Wire outer diameter: 4-8mm;  
Wiring capacity: Max 1.5mm<sup>2</sup>;  
IP rated: IP65;  
Applicable connector inside:  
OJ-831、OJ-863、OJ-8631、  
OJ-PA9-3;

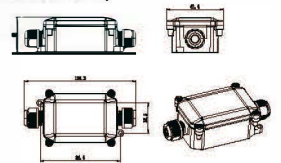

NEW



### CM-5718-B

一进两出防水盒;  
材料: PA, 环保阻燃;  
参数: 17.5A, 450V, T85°C;  
阻燃等级: 灼热丝试验850°C;  
接线范围: 4-8mm;  
适配电线: Max 1.5mm<sup>2</sup>;  
防护等级: IP65;  
适配端子台: OJ-831、OJ-863、OJ-8631、OJ-PA9-3  
外接PG9或M16防水头;

获得认证:

1 in and 2 out waterproof box;  
Housing: PA, fire resistant;  
Ratings: 17.5A, 450V, T85°C;  
Category to heat and fire: glow wire test 850°C;  
Wire outer diameter: 4-8mm;  
Wiring capacity: Max 1.5mm<sup>2</sup>;  
IP rated: IP65;  
Applicable connector inside:  
OJ-831、OJ-863、OJ-8631、  
OJ-PA9-3  
Applicable connector outside:  
PG9 or M16 waterproof connector.

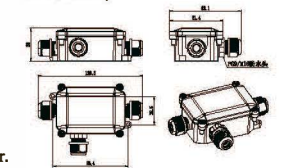

NEW



### CM-5818-A

两进两出防水盒;  
材料: PC, 环保阻燃;  
参数: 24A, 450V, T85°C;  
阻燃等级: 灼热丝试验850°C;  
接线范围: 5-10mm;  
适配电线: Max 2.5mm<sup>2</sup>;  
防护等级: IP68;  
适配端子台: OJ-851、OJ-865、OJ-PA9-5;

获得认证:

2 in and 2 out waterproof box;  
Housing: PC, fire resistant;  
Ratings: 24A, 450V, T85°C;  
Category to heat and fire: glow wire test 850°C;  
Wire outer diameter: 5-10mm;  
Wiring capacity: Max 2.5mm<sup>2</sup>;  
IP rated: IP68;  
Applicable connector inside:  
OJ-851、OJ-865、OJ-PA9-5;

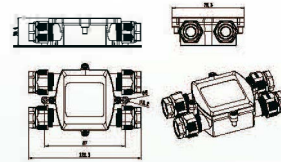

NEW



### CM-5818-B

一进两出防水盒;  
材料: PC, 环保阻燃;  
参数: 24A, 450V, T85°C;  
阻燃等级: 灼热丝试验850°C;  
接线范围: 5-10mm;  
适配电线: Max 2.5mm<sup>2</sup>;  
防护等级: IP68;  
适配端子台: OJ-851、OJ-865、OJ-PA9-5;

获得认证:

1 in and 2 out waterproof box;  
Housing: PC, fire resistant;  
Ratings: 24A, 450V, T85°C;  
Category to heat and fire: glow wire test 850°C;  
Wire outer diameter: 5-10mm;  
Wiring capacity: Max 2.5mm<sup>2</sup>;  
IP rated: IP68;  
Applicable connector inside:  
OJ-851、OJ-865、OJ-PA9-5;

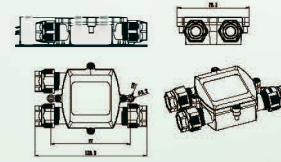

NEW



### CM-M16/M16S

mini板对接防水直管/线对线防水直管;  
材料: PA, 环保阻燃;  
参数: 10A, 250V, T110°C;  
阻燃等级: 灼热丝试验850°C;  
接线范围: 4-6.5mm;  
适配电线: Max 0.75mm<sup>2</sup>;  
防护等级: IP68;  
接线端子: 三芯;

获得认证:

Mini board-to-wire waterproof tube/Mini wire-to-wire waterproof tube;  
Housing: PA, fire resistant;  
Ratings: 10A, 250V, T110°C;  
Category to heat and fire: glow wire test 850°C;  
Wire outer diameter: 4-6.5mm;  
Wiring capacity: Max 0.75mm<sup>2</sup>;  
IP rated: IP68;  
Wiring cores: 3 core

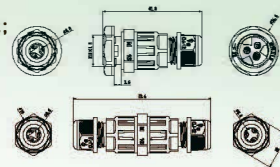

NEW



### CM-M20/M20S

板对接防水直管/线对线防水直管;  
材料: PA, 环保阻燃;  
参数: 13A, 400V, T110°C;  
阻燃等级: 灼热丝试验850°C;  
接线范围: 5-10mm;  
适配电线: Max 1.5mm<sup>2</sup>;  
防护等级: IP68;  
接线端子: 四芯

获得认证:

board-to-wire waterproof tube/wire-to-wire waterproof tube;  
Housing: PA, fire resistant;  
Ratings: 13A, 400V, T110°C;  
Category to heat and fire: glow wire test 850°C;  
Wire outer diameter: 5-10mm;  
Wiring capacity: Max 1.5mm<sup>2</sup>;  
IP rated: IP68;  
Wiring cores: 4 cores

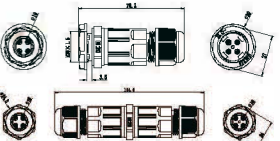

NEW



### CM-M20W

一拖二线对线防水直管;  
材料: PA, 环保阻燃;  
参数: 13A, 400V, T110°C;  
阻燃等级: 灼热丝试验850°C;  
接线范围: 单孔: 5-10mm, 双孔: 4-6.5mm;  
适配电线: 单孔: Max 1.5mm<sup>2</sup>, 双孔: Max 0.75mm<sup>2</sup>;  
防护等级: IP68;  
接线端子: 四芯

获得认证:

1 in and 2 out wire-to-wire waterproof tube;  
Housing: PA, fire resistant;  
Ratings: 13A, 400V, T110°C;  
Category to heat and fire: glow wire test 850°C;  
Wire outer diameter: 1 in: 5-10mm, 2 out: 4-6.5mm;  
Wiring capacity: 1 in: Max 1.5mm<sup>2</sup>, 2 out: Max 0.75mm<sup>2</sup>;  
IP rated: IP68;  
Wiring cores: 4 cores

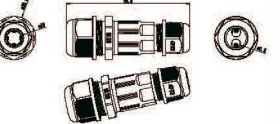

NEW



### CM-M25S

一拖三线对线防水直管;  
材料: PA, 环保阻燃;  
参数: 32A, 400V, T110°C;  
阻燃等级: 灼热丝试验850°C;  
接线范围: 单孔: 8-11mm, 三孔: 5-8mm;  
适配电线: 单孔: Max 4mm<sup>2</sup>, 三孔: Max 1.5mm<sup>2</sup>;  
防护等级: IP68;  
接线端子: 三芯

获得认证:

1 in and 3 out wire-to-wire waterproof tube;  
Housing: PA, fire resistant;  
Ratings: 32A, 400V, T110°C;  
Category to heat and fire: glow wire test 850°C;  
Wire outer diameter: 1 in: 8-11mm, 3 out: 5-8mm;  
Wiring capacity: 1 in: Max 4mm<sup>2</sup>, 3 out: Max 1.5mm<sup>2</sup>;  
IP rated: IP68;  
Wiring cores: 3 cores



NEW



### CM-M25W

一拖四线对线防水直管;  
材料: PA, 环保阻燃;  
参数: 32A, 400V, T110°C;  
阻燃等级: 灼热丝试验850°C;  
接线范围: 单孔: 8-11mm, 四孔: 4-6.5mm;  
适配电线: 单孔: Max 4mm<sup>2</sup>, 四孔: Max 0.75mm<sup>2</sup>;  
防护等级: IP68;  
接线端子: 四芯

获得认证:

1 in and 4 out wire-to-wire waterproof tube;  
Housing: PA, fire resistant;  
Ratings: 32A, 400V, T110°C;  
Category to heat and fire: glow wire test 850°C;  
Wire outer diameter: 1 in: 8-11mm, 4 out: 4-6.5mm;  
Wiring capacity: 1 in: Max 4mm<sup>2</sup>, 4 out: Max 0.75mm<sup>2</sup>;  
IP rated: IP68;  
Wiring cores: 4 cores

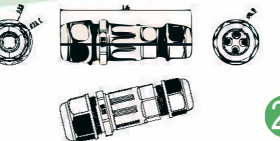



## CM-821 H

材料: PP  
阻燃等级: 灼热丝850℃

Item No.: OJ-821H  
Junction box with 2 poles push wire connector  
Material: PP  
Category to heat and fire: 850℃

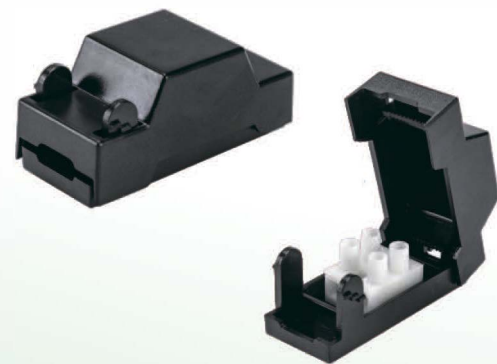
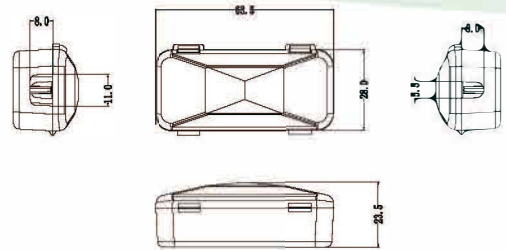

## CM-821 H mini

材料: PP  
阻燃等级: 灼热丝850℃

Item No.: OJ-821H mini  
Junction box with 2 poles push wire connector  
Material: PP  
Category to heat and fire: 850℃

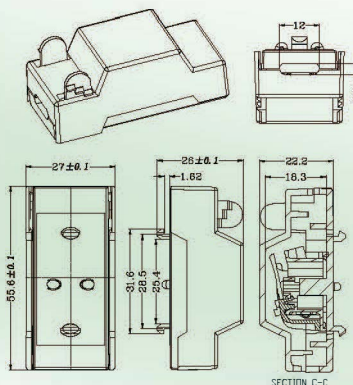

## CM-831 H

材料: PP  
阻燃等级: 灼热丝850℃

Item No.: OJ-831H  
Junction box with 3 poles push wire connector  
Material: PP  
Category to heat and fire: 850℃

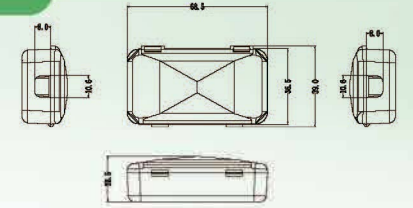

## CM-862H/863H

材料: PP  
阻燃等级: 灼热丝850℃

Item No.: OJ-862H/863H  
Junction box with 2/3 poles push wire connector  
Material: PP  
Category to heat and fire: 850℃

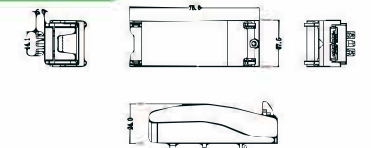

## CM-841 H

材料: PP  
阻燃等级: 灼热丝850℃

Item No.: OJ-841H  
Junction box with 4 poles push wire connector  
Material: PP  
Category to heat and fire: 850℃

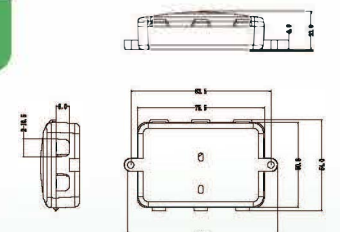

NEW



### CM 303

免剥皮软线开关

材料: PC/PP,环保阻燃

五金件: 环保铜 镀镍; 电流/电压: 2@2A 250V~

阻燃等级: 灼热丝试验 850℃ UL94V-2

适配电线: H03VVH2-F 2x0.5mm<sup>2</sup>  
H03VVH2-F 2x0.75mm<sup>2</sup>  
52RVV 2x0.5mm<sup>2</sup>  
52RVV 2x0.75mm<sup>2</sup>

获得认证:

Patent: 201720370257.5  
201730155711.0

Item No.: OJ-368 line switch

Applications: applicable to lighting products and other electrical products

Housing: PC/PP, comply with RoHS, PAHs, SVHC

Insert: nickel plated brass; Ratings: 2@2A 250V~

Category to heat and fire: glow wire test 850 degrees Celsius ; UL94V-2

Wiring Capacity:

H03VVH2-F 2x0.5mm<sup>2</sup>

H03VVH2-F 2x0.75mm<sup>2</sup>

52RVV 2x0.5mm<sup>2</sup>

52RVV 2x0.75mm<sup>2</sup>

免剥皮  
免端子  
免压接  
no stripping  
no crimping

NEW



### CM 304

免剥皮软线开关

材料: PC/PP,环保阻燃

五金件: 环保铜 镀镍; 电流/电压: 2@2A 250V~

阻燃等级: 灼热丝试验 850℃ UL94V-2

适配电线: H03VVH2-F 2x0.5mm<sup>2</sup>  
H03VVH2-F 2x0.75mm<sup>2</sup>  
52RVV 2x0.5mm<sup>2</sup>  
52RVV 2x0.75mm<sup>2</sup>

获得认证:

Patent: 201720370257.5  
201730155711.0

Item No.: OJ-368 line switch

Applications: applicable to lighting products and other electrical products

Housing: PC/PP, comply with RoHS, PAHs, SVHC

Insert: nickel plated brass; Ratings: 2@2A 250V~

Category to heat and fire: glow wire test 850 degrees Celsius ; UL94V-2

Wiring Capacity:

H03VVH2-F 2x0.5mm<sup>2</sup>

H03VVH2-F 2x0.75mm<sup>2</sup>

52RVV 2x0.5mm<sup>2</sup>

52RVV 2x0.75mm<sup>2</sup>

免剥皮  
免端子  
免压接  
no stripping  
no crimping

NEW



### CM-327

压接式脚踏开关

材料: PP/PC, 环保阻燃

五金件: 环保铜 镀镍; 电流/电压: 2@2A 250V~ ;

阻燃等级: 灼热丝试验850℃ UL94V-2

H03VVH2-F 2x0.75mm<sup>2</sup>  
H03VV-F 3G0.75mm<sup>2</sup>  
52RVV 2x0.75mm<sup>2</sup>  
52RVV 3G0.75mm<sup>2</sup>  
SPT-2 18AWGx2C

获得认证:

Patent: 201720609714.1

Item No.: OJ-327 foot switch

Applications: applicable to lighting products and other electrical products

Housing: PP/PC, comply with RoHS, PAHs, SVHC

Insert: nickel plated brass; Ratings: 2@2A 250V~ ;

Category to heat and fire: glow wire test 850 degrees Celsius ; UL94V-2

Wiring Capacity:

H03VVH2-F 2x0.75mm<sup>2</sup>

H03VV-F 3G0.75mm<sup>2</sup>

52RVV 2x0.75mm<sup>2</sup>

52RVV 3G0.75mm<sup>2</sup>

SPT-2 18AWGx2C

免螺丝  
快速安装  
screw free / quick press fit

NEW



### CM-368

免剥皮软线开关

材料: PC/PP,环保阻燃

五金件: 环保铜 镀镍; 电流/电压: 2@2A 250V~

阻燃等级: 灼热丝试验 850℃ UL94V-2

适配电线: H03VVH2-F 2x0.5mm<sup>2</sup>  
H03VVH2-F 2x0.75mm<sup>2</sup>  
52RVV 2x0.5mm<sup>2</sup>  
52RVV 2x0.75mm<sup>2</sup>

获得认证:

Patent: 201720370257.5  
201730155711.0

Item No.: OJ-368 line switch

Applications: applicable to lighting products and other electrical products

Housing: PC/PP, comply with RoHS, PAHs, SVHC

Insert: nickel plated brass; Ratings: 2@2A 250V~

Category to heat and fire: glow wire test 850 degrees Celsius ; UL94V-2

Wiring Capacity:

H03VVH2-F 2x0.5mm<sup>2</sup>

H03VVH2-F 2x0.75mm<sup>2</sup>

52RVV 2x0.5mm<sup>2</sup>

52RVV 2x0.75mm<sup>2</sup>

免剥皮  
免端子  
免压接  
no stripping  
no crimping

## CM-304



适用范围: 适用于各种携带电源线控制的灯饰产品、电器  
 材料: 外壳PC/PP, 环保阻燃  
 单极通断  
 五金件: 环保铜镀镍; 电流/电压: 2@2A 250V~; 3A 125V~  
 阻燃等级: 灼热丝试验850℃; UL94v-2  
 适配电线:  
 H03VVH2-F 2x0.75mm<sup>2</sup>  
 52RVV 2x0.75mm<sup>2</sup>  
 52RVV 3x0.75mm<sup>2</sup>  
 SPT-2 18AWGx2c

获得认证: 05 KEMA CCC cULus E354212 CE

Item No.: OJ-304  
 Applications: applicable to lighting products and other electrical products  
 Housing: PC/PP, comply with RoHS, PAHs, SVHC  
 Single pole  
 Insert: nickel plated brass; Ratings: 2@2A 250V~; 3A 125V~  
 Category to heat and fire: glow wire test 850 degrees Celsius; UL94v-2  
 Wiring Capacity:  
 H03VVH2-F 2x0.75mm<sup>2</sup>  
 52RVV 2x0.75mm<sup>2</sup>  
 52RVV 3x0.75mm<sup>2</sup>  
 SPT-2 18AWGx2c

## CM 8s.304

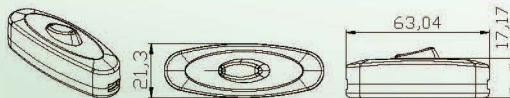

适用范围: 适用于各种携带电源线控制的灯饰产品、电器  
 材料: 外壳PC/PP, 环保阻燃  
 单极通断  
 五金件: 环保铜镀镍; 电流/电压: 2@2A 250V~  
 阻燃等级: 灼热丝试验850℃  
 适配电线:  
 H03VVH2-F 2x0.75mm<sup>2</sup>  
 VFF 2x0.75mm<sup>2</sup>

获得认证: 05 KEMA CCC PS E JET CE

Patent: 200630178537.3  
 200720048184.4

Item No.: 8s.304  
 Applications: applicable to lighting products and other electrical products  
 Housing: PC/PP, comply with RoHS, PAHs, SVHC  
 Single pole  
 Insert: nickel plated brass; Ratings: 2@2A 250V~  
 Category to heat and fire: glow wire test 850 degrees Celsius  
 Wiring Capacity:  
 H03VVH2-F 2x0.75mm<sup>2</sup>  
 VFF 2x0.75mm<sup>2</sup>

## CM: 8s.303

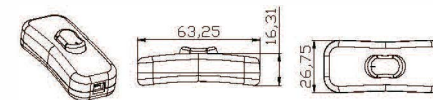

适用范围: 适用于各种携带电源线控制的灯饰产品、电器  
 材料: PC/PP, 环保阻燃  
 单极/双极通断  
 五金件: 环保铜镀镍; 电流/电压: 2@2A, 250V~  
 阻燃等级: 灼热丝试验850℃  
 适配电线:  
 H03VVH2-F 2x0.75mm<sup>2</sup>  
 H03VVH2-F 2x0.5mm<sup>2</sup>  
 H03VV-F 3G0.75mm<sup>2</sup>  
 52RVV 2x0.75mm<sup>2</sup>  
 52RVV 3x0.75mm<sup>2</sup>

获得认证: 05 KEMA CCC CE

Patent: 200630072728.1  
 200720048183.X

Item No.: 8s.303  
 Applications: applicable to lighting products and other electrical products  
 Housing: PC/PP, comply with RoHS, PAHs, SVHC  
 Single pole/double poles  
 Insert: nickel plated brass; Ratings: 2@2A 250V~  
 Category to heat and fire: glow wire test 850 degrees Celsius  
 Wiring Capacity:  
 H03VVH2-F 2x0.75mm<sup>2</sup>  
 H03VVH2-F 2x0.5mm<sup>2</sup>  
 H03VV-F 3G0.75mm<sup>2</sup>  
 52RVV 2x0.75mm<sup>2</sup>  
 52RVV 3x0.75mm<sup>2</sup>

## CM-303

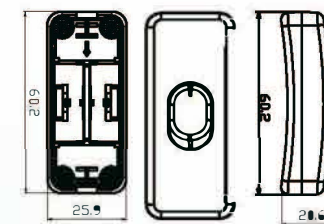

适用范围: 适用于各种携带电源线控制的灯饰产品、电器  
 材料: PC/PP  
 单极/双极通断  
 五金件: 环保铜镀镍; 电流/电压: 2@2A, 250V~ 3A, 125V~  
 阻燃等级: 灼热丝试验850℃、94V-2  
 适配电线:  
 H03VVH2-F 2x0.75mm<sup>2</sup>  
 H03VV-F 3G0.75mm<sup>2</sup>  
 52RVV 2x0.75mm<sup>2</sup>  
 52RVV 3x0.75mm<sup>2</sup>  
 SPT-2 18AWGx2C

获得认证: 05 KEMA CCC E354212 CE

Item No.: OJ-303  
 Applications: applicable to lighting products and other electrical products  
 Housing: PC/PP  
 Single pole/double poles  
 Insert: nickel plated brass; Ratings: 2@2A 250V~ 3A, 125V~  
 Category to heat and fire: glow wire test 850 degrees Celsius, 94V-2  
 Wiring Capacity:  
 H03VVH2-F 2x0.75mm<sup>2</sup>  
 SPT-2 18AWGx2C  
 H03VV-F 3G0.75mm<sup>2</sup>  
 52RVV 2x0.75mm<sup>2</sup>  
 52RVV 3x0.75mm<sup>2</sup>

## CM-313

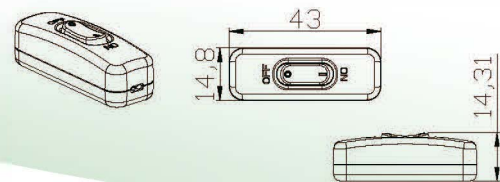

LED、DC线专用开关  
 适用范围：携带电线的LED灯饰产品  
 材料：外壳PC，环保阻燃  
 单极通断  
 五金件：环保铜 镀镍；电流/电压：2@2A 250V~  
 阻燃等级：灼热丝试验850℃  
 适配电线：  
 圆孔：H03VVH7-H 1x0.5mm<sup>2</sup>

获得认证：

Item No.: OJ-313 mini switch  
 Applications: applicable to lighting products and other electrical products  
 Housing: PC, comply with RoHS, PAHs, SVHC  
 Insert: nickel plated brass; Ratings: 2@2A 250V~  
 Category to heat and fire: glow wire test 850 degrees Celsius  
 Wiring Capacity:  
 H03VVH7-H 1x0.5mm<sup>2</sup>

## CM-318



适用范围：适用于各种携带电源线控制的灯饰产品、电器  
 材料：外壳PA，环保阻燃  
 单极/双极通断  
 五金件：环保铜 镀镍；电流/电压：2@2A, 250V~  
 阻燃等级：灼热丝试验850℃  
 适配电线：  
 H03VVH2-F 2x0.75mm<sup>2</sup>

获得认证：

Item No.: OJ-318  
 Applications: applicable to lighting products and other electrical products  
 Housing: PA, comply with RoHS, PAHs, SVHC  
 Single pole/double poles  
 Insert: nickel plated brass; Ratings: 2@2A 250V~  
 Category to heat and fire: glow wire test 850 degrees Celsius  
 Wiring Capacity:  
 H03VVH2-F 2x0.75mm<sup>2</sup>

## CM-315

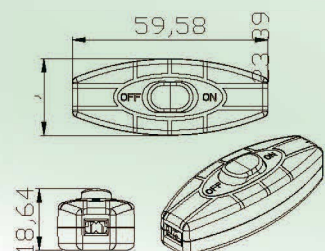

适用范围：适用于各种携带电源线控制的灯饰产品、电器  
 材料：外壳PC，环保阻燃  
 单极通断  
 五金件：环保铜 镀镍；电流/电压：3A 125V~  
 阻燃等级：UL94v-2  
 适配电线：SPT-2 18AWGx2c

获得认证：

Patent: 201230657718.X

Item No.: OJ-315  
 Applications: applicable to lighting products and other electrical products  
 Housing: PC, comply with RoHS, PAHs, SVHC  
 Single pole  
 Insert: nickel plated brass; Ratings: 3A 125V~  
 Category to heat and fire: UL94v-2  
 Wiring Capacity:  
 SPT-2 18AWGx2c

## CM-328

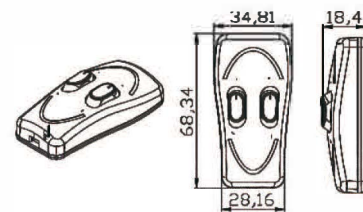

一进两出按钮开关  
 适用范围：适用于各种携带电源线控制的灯饰产品、电器  
 材料：外壳PC/PP，环保阻燃  
 五金件：环保铜 镀镍；电流/电压：3@1A 250V~  
 阻燃等级：灼热丝试验850℃  
 适配电线：H03VVH2-F 2x0.75mm<sup>2</sup>

获得认证：

Patent: 201230657302.8

Item No.: OJ-328 two way switch  
 Applications: applicable to lighting products and other electrical products  
 Housing: PC/PP, comply with RoHS, PAHs, SVHC  
 Insert: nickel plated brass; Ratings: 3@1A 250V~  
 Category to heat and fire: glow wire test 850 degrees Celsius  
 Wiring Capacity:  
 H03VVH2-F 2x0.75mm<sup>2</sup>

## CM-8138

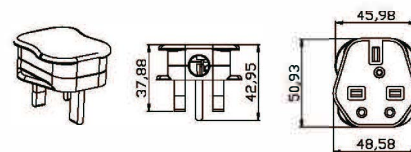

英式组装插头  
 材料：外壳PC，环保阻燃  
 五金件：环保铜；电流/电压：3A 250V~，5A 250V~，13A 250V~  
 阻燃等级：灼热丝试验850℃  
 适配电线：0.5-1.5mm<sup>2</sup>  
 Item No.: OJ-8138 BS plug

获得认证：

Applications: applicable to lighting products and other electrical products  
 Housing: PC, comply with RoHS, PAHs, SVHC  
 Insert: brass; Ratings: 3A 250V~, 5A 250V~, 13A 250V~  
 Category to heat and fire: glow wire test 850 degrees Celsius  
 Wiring Capacity:  
 0.5-1.5mm<sup>2</sup>

## CM-316

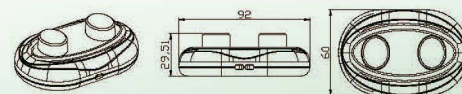

一进两出脚踏开关  
 适用范围：适用于各种携带电源线控制的灯饰产品、电器  
 材料：外壳PC，环保阻燃  
 五金件：环保铜 镀镍；电流/电压：2@1A 250V~  
 阻燃等级：灼热丝试验850℃  
 适配电线：H03VVH2-F 2x0.75mm<sup>2</sup>

获得认证：

Item No.: OJ-316 two way foot switch  
 Applications: applicable to lighting products and other electrical products  
 Housing: PC, comply with RoHS, PAHs, SVHC  
 Insert: nickel plated brass; Ratings: 2@1A 250V~  
 Category to heat and fire: glow wire test 850 degrees Celsius  
 Wiring Capacity:  
 H03VVH2-F 2x0.75mm<sup>2</sup>

## CM-336

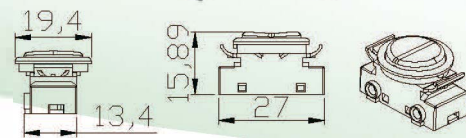

**面板按钮开关**  
 适用范围: 适用于各种台灯, 桌灯, 落地灯等灯饰产品及各种电器  
 材料: 外壳PC, 环保阻燃  
 五金件: 环保铜 镀镍; 电流/电压: 201A 250V~  
 阻燃等级: 灼热丝试验850℃  
 适配电线: 0.5-1.0mm<sup>2</sup>

获得认证: 05 KEMA CCC CE

Item No.: OJ-336 lamp switch  
 Applications: applicable to lighting products such as table lamp, desk lamp  
 Housing: PC, comply with RoHS, PAHs, SVHC  
 Insert: nickel plated brass; Ratings: 201A 250V~  
 Category to heat and fire: glow wire test 850 degrees Celsius  
 Wiring Capacity:  
 0.5-1.0mm<sup>2</sup>

## CM-200

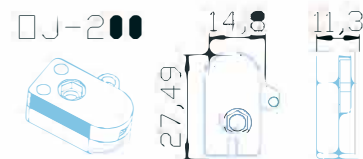

**拉线开关**  
 适用范围: 适用于各种携带电源线控制的灯饰产品、电器  
 材料: PC/PA, 环保阻燃  
 五金件: 环保铜 镀镍; 电流/电压: 202A 250V~  
 阻燃等级: 灼热丝试验850℃  
 适配电线: 0.5-1.0mm<sup>2</sup>

获得认证: 05 KEMA CE

Item No.: 200 pull switch  
 Applications: applicable to lighting products and other electrical products  
 Housing: PC/PA, comply with RoHS, PAHs, SVHC  
 Insert: nickel plated brass; Ratings: 202A 250V~  
 Category to heat and fire: glow wire test 850 degrees Celsius  
 Wiring Capacity:  
 0.5-1.0mm<sup>2</sup>

## CM-09C

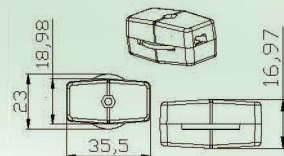

**齿轮开关**  
 适用范围: 适用于各种携带电源线控制的灯饰产品、电器  
 材料: 外壳ABS/PC, 环保阻燃  
 单极通断  
 五金件: 环保铜 镀镍; 电流/电压: 3A 125V~  
 阻燃等级: UL94v-2  
 适配电线: SPT-2 18AWGx2c

获得认证: E354212

Item No.: OJ-09C rotary switch  
 Applications: applicable to lighting products and other electrical products  
 Housing: ABS/PC, comply with RoHS, PAHs, SVHC  
 Single pole  
 Insert: nickel plated brass; Ratings: 3A 125V~  
 Category to heat and fire: UL94v-2  
 Wiring Capacity:  
 SPT-2 18AWGx2c

## CM-337/337b

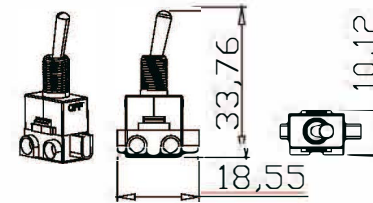

**摇柄开关**  
 材料: 外壳PA, 环保阻燃  
 五金件: 环保铜 镀镍; 电流/电压: 201A 250V~  
 阻燃等级: 灼热丝试验850℃  
 适配电线: 0.5-1.0mm<sup>2</sup>

获得认证: 05 KEMA CCC CE

Patent: 201430054812.5  
 201420105861.1  
 Item No.: OJ-337 toggle switch  
 Applications: applicable to lighting products and other electrical products  
 Housing: PA, comply with RoHS, PAHs, SVHC  
 Insert: silver plated brass; Ratings: 201A 250V~  
 Category to heat and fire: glow wire test 850 degrees Celsius  
 Wiring Capacity:  
 0.5-1.0mm<sup>2</sup>

## CM-377

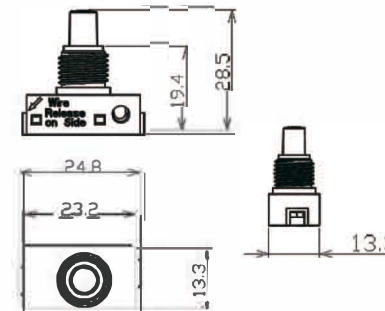

适用范围: 适用于各种电器  
 材料: 外壳PC, 环保阻燃  
 电流/电压: 202A 250V~;  
 阻燃等级: 灼热丝试验850℃;  
 适配电线:  
 0.5mm<sup>2</sup>, 0.75mm<sup>2</sup>, 1.0mm<sup>2</sup>;

获得认证: 05 KEMA CCC CE

Item No.: OJ-377  
 Applications: applicable to lighting products and other electrical products  
 Housing: PC, comply with RoHS, PAHs, SVHC  
 Ratings: 202A 250V~;  
 Category to heat and fire: glow wire test 850 degrees Celsius ;  
 Wiring Capacity:  
 0.5mm<sup>2</sup>, 0.75mm<sup>2</sup>, 1.0mm<sup>2</sup> ;