

MOS FET Relays G3VM-352C/F

MOS FET Relay Series with 350-V Load Voltage Including Models with 2 Outputs.

- Upgraded G3VM-W Series.
- Continuous load current of 120 mA.
- Dielectric strength of 2,500 Vrms between I/O.
- RoHS Compliant.

Application Examples

- Measurement devices
- Security systems
- Amusement machines

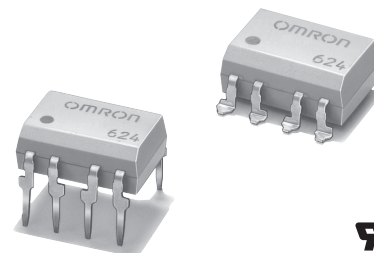

Note: The actual product is marked differently from the image shown here.

List of Models

Contact form	Terminals	Load voltage (peak value)	Model	Number per stick	Number per tape
DPST-NO	PCB terminals	350 VAC	G3VM-352C	50	---
	Surface-mounting terminals		G3VM-352F		
			G3VM-352F(TR)	---	1,500

Dimensions

Note: All units are in millimeters unless otherwise indicated.

G3VM-352C

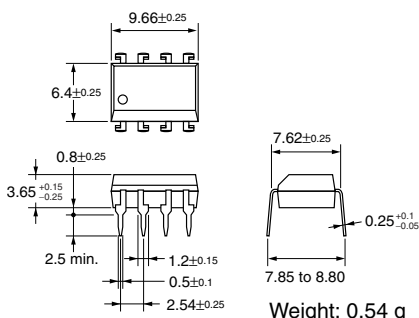
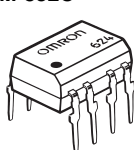

Note: The actual product is marked differently from the image shown here.

G3VM-352F

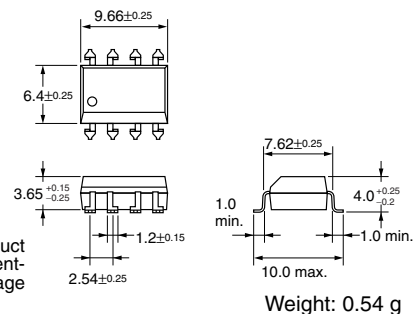
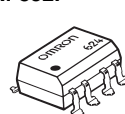

Note: The actual product is marked differently from the image shown here.

Terminal Arrangement/Internal Connections (Top View)

G3VM-352C

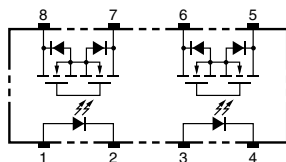

G3VM-352F

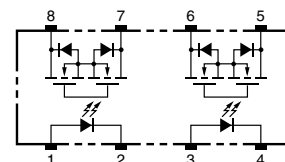

PCB Dimensions (Bottom View)

G3VM-352C

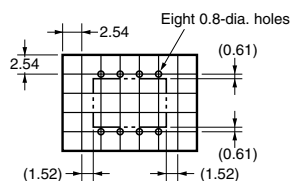

Actual Mounting Pad Dimensions (Recommended Value, Top View)

G3VM-352F

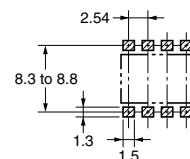

■ Absolute Maximum Ratings (Ta = 25°C)

Item	Symbol	Rating	Unit	Measurement conditions	
Input	LED forward current	I_F	50	mA	
	Repetitive peak LED forward current	I_{FP}	1	A	100 μ s pulses, 100 pps
	LED forward current reduction rate	$\Delta I_F/^\circ\text{C}$	-0.5	mA/ $^\circ\text{C}$	Ta \geq 25°C
	LED reverse voltage	V_R	5	V	
	Connection temperature	T_j	125	$^\circ\text{C}$	
Output	Load voltage (AC peak/DC)	V_{OFF}	350	V	
	Continuous load current	I_O	120	mA	
	ON current reduction rate	$\Delta I_{ON}/^\circ\text{C}$	-1.2	mA/ $^\circ\text{C}$	Ta \geq 25°C
	Connection temperature	T_j	125	$^\circ\text{C}$	
Dielectric strength between input and output (See note 1.)		V_{I-O}	2,500	V_{rms}	AC for 1 min
Operating temperature		T_a	-40 to +85	$^\circ\text{C}$	With no icing or condensation
Storage temperature		T_{stg}	-55 to +125	$^\circ\text{C}$	With no icing or condensation
Soldering temperature (10 s)		---	260	$^\circ\text{C}$	10 s

Note: 1. The dielectric strength between the input and output was checked by applying voltage between all pins as a group on the LED side and all pins as a group on the light-receiving side.

■ Electrical Characteristics (Ta = 25°C)

Item	Symbol	Minimum	Typical	Maximum	Unit	Measurement conditions	
Input	LED forward voltage	V_F	1.0	1.15	1.3	V	$I_F = 10$ mA
	Reverse current	I_R	---	---	10	μA	$V_R = 5$ V
	Capacity between terminals	C_T	---	30	---	pF	$V = 0$, $f = 1$ MHz
	Trigger LED forward current	I_{FT}	---	1	3	mA	$I_O = 120$ mA
Output	Maximum resistance with output ON	R_{ON}	---	25	35	Ω	$I_F = 5$ mA, $I_O = 120$ mA, $t < 1$ s
			---	35	50	Ω	$I_F = 5$ mA, $I_O = 120$ mA
	Current leakage when the relay is open	I_{LEAK}	---	0.0015	1.0	μA	$V_{OFF} = 350$ V
Capacity between terminals		C_{OFF}	---	30	---	pF	$V = 0$, $f = 1$ MHz,
Capacity between I/O terminals		C_{I-O}	---	0.8	---	pF	$f = 1$ MHz, $V_s = 0$ V
Insulation resistance		R_{I-O}	1,000	---	---	M Ω	$V_{I-O} = 500$ VDC, $R_{oH} \leq 60\%$
Turn-ON time		t_{ON}	---	0.3	1.0	ms	$I_F = 5$ mA, $R_L = 200 \Omega$, $V_{DD} = 20$ V (See note 2.)
Turn-OFF time		t_{OFF}	---	0.1	1.0	ms	

Note: 2. Turn-ON and Turn-OFF Times

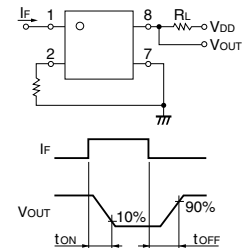

■ Recommended Operating Conditions

Use the G3VM under the following conditions so that the Relay will operate properly.

Item	Symbol	Minimum	Typical	Maximum	Unit
Load voltage (AC peak/DC)	V_{DD}	---	---	280	V
Operating LED forward current	I_F	5	7.5	25	mA
Continuous load current (AC peak/DC)	I_O	---	---	100	mA
Operating temperature	T_a	-20	---	65	$^\circ\text{C}$

■ Engineering Data

LED forward current vs. Ambient temperature

$I_F - T_a$

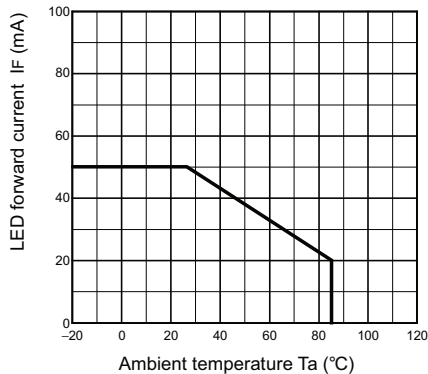

Continuous load current vs. Ambient temperature

$I_O - T_a$

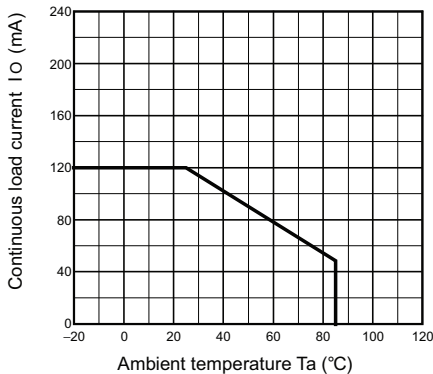

LED forward current vs. LED forward voltage

$I_F - V_F$

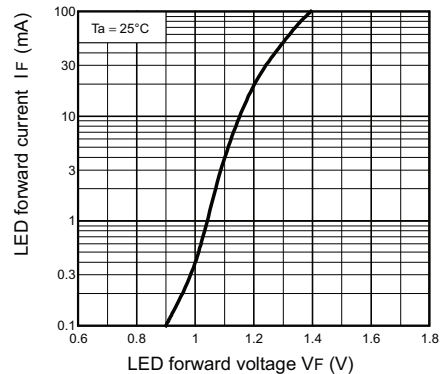

Continuous load current vs. On-state voltage

$I_O - V_{ON}$

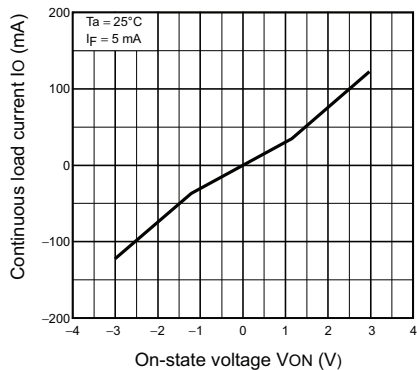

On-state resistance vs. Ambient temperature

$R_{ON} - T_a$

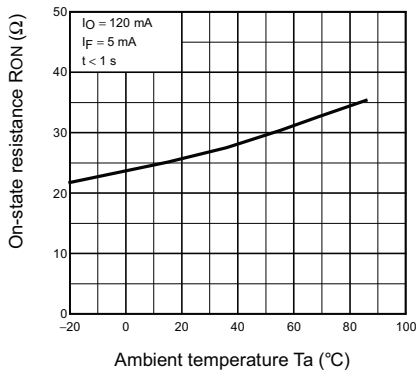

Trigger LED forward current vs. Ambient temperature

$I_{FT} - T_a$

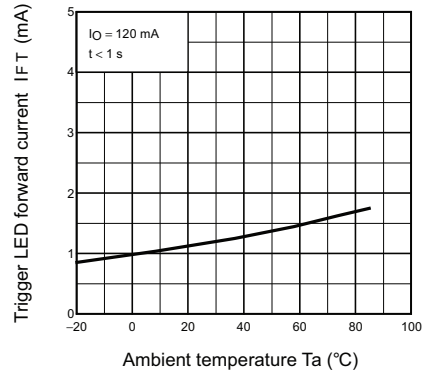

Turn ON, Turn OFF time vs. LED forward current

$t_{ON}, t_{OFF} - I_F$

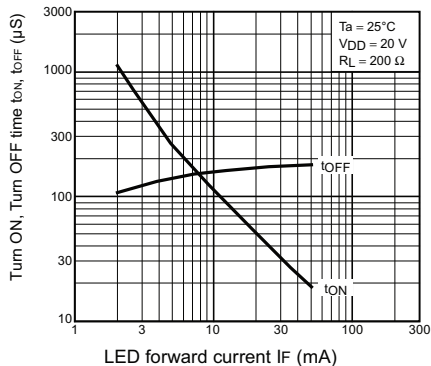

Turn ON, Turn OFF time vs. Ambient temperature

$t_{ON}, t_{OFF} - T_a$

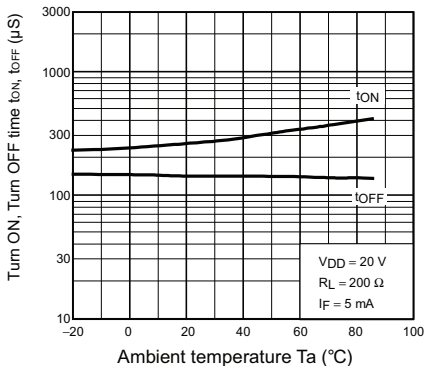

Current leakage vs. Ambient temperature

$I_{LEAK} - T_a$

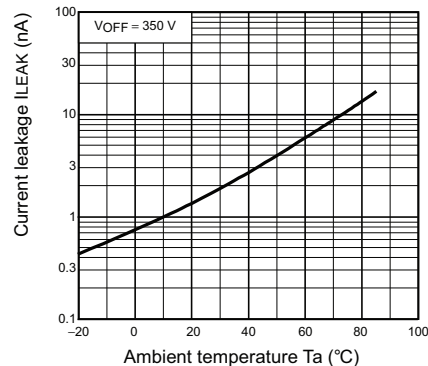

All sales are subject to Omron Electronic Components LLC standard terms and conditions of sale, which can be found at http://www.components.omron.com/components/web/webfiles.nsf/sales_terms.html

ALL DIMENSIONS SHOWN ARE IN MILLIMETERS.
To convert millimeters into inches, multiply by 0.03937. To convert grams into ounces, multiply by 0.03527.

OMRON[®]

**OMRON ELECTRONIC
COMPONENTS LLC**

55 E. Commerce Drive, Suite B
Schaumburg, IL 60173

847-882-2288

OMRON ON-LINE

Global - <http://www.omron.com>

USA - <http://www.components.omron.com>

Cat. No. X302-E-1

12/10

Specifications subject to change without notice

Printed in USA