



**SGS-THOMSON**  
MICROELECTRONICS

**M082/A-M083/A-M086/A**

SGS-THOMSON

3OE D

**TONE GENERATORS**

NOT FOR NEW DESIGN

- SINGLE POWER SUPPLY
- WIDE SUPPLY VOLTAGE OPERATING RANGE
- LOW POWER DISSIPATION < 500mW
- 13 (M082/A, M083/A) OR 12 (M086/A) TONE OUTPUTS
- HIGH OUTPUT DRIVE CAPABILITY
- HIGH ACCURACY OF OUTPUT FREQUENCIES: ERROR LESS THAN  $\pm 0.069\%$
- INPUT PROTECTED AGAINST STATIC CHARGES
- LOW INTERMODULATION

The M082/A, M083/A and M086/A are monolithic tone generators specially designed for electronic organs. The only difference between the M082, M083, M086 and the M082A, M083A, M086A is the maximum input clock frequency, which is 4500KHz for the standard types and 2500KHz for the "A" types. Constructed on a single chip using low threshold N-channel silicon gate technology they are supplied in a 16 lead dual in-line plastic package.

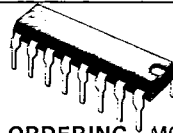

DIP-16  
(0.25)

ORDERING NUMBERS: M082 B1 M082A B1  
M083 B1 M083A B1  
M086 B1 M086A B1

**ABSOLUTE MAXIMUM RATINGS**

$V_i$	Voltage on any pin relative to $V_{SS}$ (GND)	+20 to -0.3	V
$T_{op}$	Operating temperature	0 to 50	$^{\circ}C$
$T_{stg}$	Storage temperature	-65 to 150	$^{\circ}C$

**PIN CONNECTIONS**

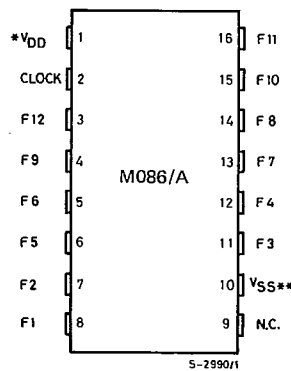
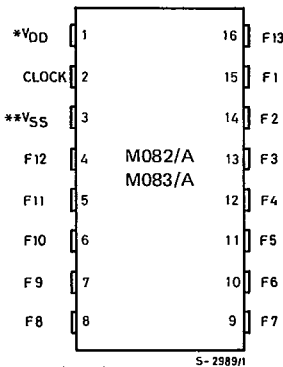

\*  $V_{DD}$  is the highest supply voltage

\*\*  $V_{SS}$  is the lowest supply voltage

SGS-THOMSON

30E D

BLOCK DIAGRAM

T-77-13

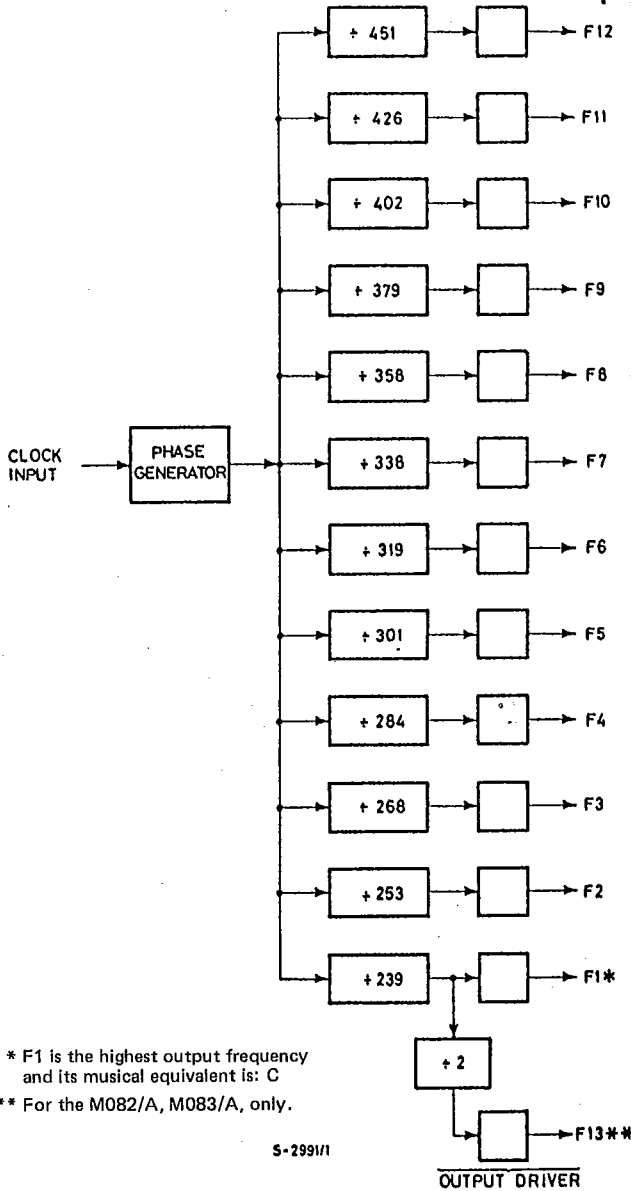

\* F1 is the highest output frequency and its musical equivalent is: C  
 \*\* For the M082/A, M083/A, only.

S-2991/1

ELECTRICAL CHARACTERISTICS (0°C ≤ T<sub>amb</sub> ≤ 50°C; V<sub>SS</sub> = 0V; V<sub>DD</sub> = +10V to +14V unless otherwise specified)

T-77-13

Parameter	Test conditions	Values			Unit	Fig.
		Min.	Typ.	Max.		
V <sub>IL</sub>	Input clock, low	V <sub>SS</sub>		V <sub>SS</sub> +1	V	1
V <sub>IH</sub>	Input clock, high	V <sub>DD</sub> -1		V <sub>DD</sub>	V	
t <sub>r</sub> , t <sub>f</sub>	Input clock rise and fall times 10% to 90%	4.5 MHz		30	ns	1
t <sub>on</sub> , t <sub>off</sub>	Input clock on and off times	4.5 MHz		111	ns	1
C <sub>I</sub>	Input capacitance		5	10	pF	
V <sub>OH</sub>	Output high	0.50 mA	V <sub>DD</sub> -1.5	V <sub>DD</sub>	V	2
V <sub>OL</sub>	Output low	0.70 mA	V <sub>SS</sub>	V <sub>SS</sub> +1	V	2
t <sub>ro</sub> , t <sub>fo</sub>	Output rise and fall times 500 pF load		250	2500	ns	3
t <sub>on</sub> , t <sub>off</sub>	Output duty cycle	M 082	30		%	
		M 083, M 086	50			
I <sub>DD</sub>	Supply current		24	35	mA	*
f <sub>I</sub>	Input clock frequency	M082, M083, M086	100	4000.48	4500	kHz
f <sub>I</sub>	Input clock frequency	M082A, M083A, M086A	100	2000.24	2500	kHz

\* Output unloaded.

Fig. 1 Input clock waveform

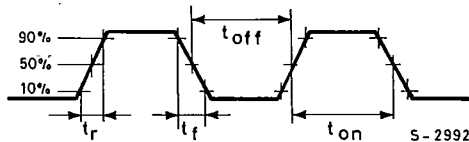
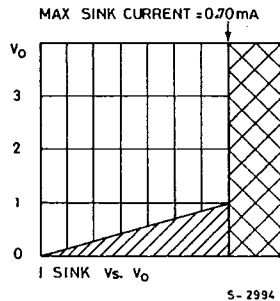
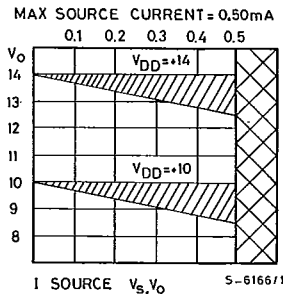

Fig. 2 - Output signal d.c. loading



(OPERATING AREA)

(CURRENT OVERLOAD AREA)

Fig. 3 - Output loading

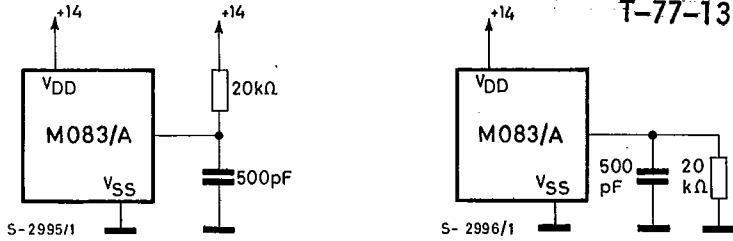

## APPLICATION INFORMATION

Keyboard frequencies for electronic organs (\*)

NOTE		OCTAVES								
		0	1	2	3	4	5	6	7	8
DOH	C	16.3516	32.7032	65.4064	130.813	261.626	523.251	1046.50	2093.00	4186.01
	C #	17.3239	34.6478	69.2957	138.591	277.183	554.365	1108.73	2217.46	4434.92
RAY	D	18.3540	36.7081	73.4162	146.832	293.665	587.330	1174.66	2349.32	4698.64
	D #	19.4454	38.8909	77.7817	155.563	311.127	622.254	1244.51	2489.02	4978.03
ME	E	20.6017	41.2034	82.4069	164.814	329.628	659.255	1318.51	2637.02	5274.04
FAH	F	21.8268	43.6536	87.3071	174.614	349.228	698.456	1396.91	2793.83	5587.66
	F #	23.1247	46.2493	92.4986	184.997	369.994	739.989	1479.98	2959.96	5919.91
SOH	G	24.4997	48.9994	97.9989	195.998	391.995	783.991	1567.98	3135.96	6271.93
	C #	25.9565	51.9131	103.826	207.652	415.305	830.609	1661.22	3322.44	6644.88
LA	A	27.5000	55.0000	110.000	220.000	440.000	880.000	1760.00	3520.00	7040.00
	A #	29.1352	58.2705	116.541	233.082	466.164	932.328	1864.66	3729.31	7458.62
TE	B	30.8671	63.7354	123.471	246.942	493.883	987.767	1975.53	3951.07	7902.13

(\*) The frequencies can be obtained from a 99680Hz (or multiples) master oscillator by the following division ratios, and subsequent repeated division by 2

C# ÷ 451	F ÷ 358	A ÷ 284
D ÷ 426	F# ÷ 338	B <sup>b</sup> ÷ 268
E <sup>b</sup> ÷ 402	G ÷ 319	B ÷ 253
E ÷ 379	G# ÷ 301	C ÷ 239

The frequency error in these approximations is less than ± 0.069%.