

BCR8CS

MEDIUM POWER USE
NON-INSULATED TYPE, PLANAR PASSIVATION TYPE

BCR8CS



- **IT (RMS)** **8A**
- **VDRM** **400V/600V**
- **IFGT I , IRGT I , IRGT III** **30mA (20mA) *5**

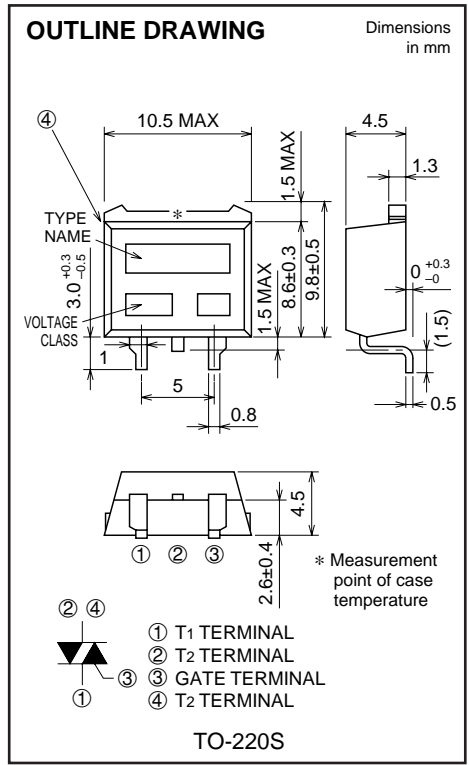

APPLICATION
Solid state relay, hybrid IC

MAXIMUM RATINGS

Symbol	Parameter	Voltage class		Unit
		8	12	
VDRM	Repetitive peak off-state voltage *1	400	600	V
VDSM	Non-repetitive peak off-state voltage *1	500	720	V

Symbol	Parameter	Conditions	Ratings	Unit
IT (RMS)	RMS on-state current	Commercial frequency, sine full wave 360° conduction, Tc=105°C	8	A
ITSM	Surge on-state current	60Hz sinewave 1 full cycle, peak value, non-repetitive	80	A
I ² t	I ² t for fusing	Value corresponding to 1 cycle of half wave 60Hz, surge on-state current	26	A ² s
PGM	Peak gate power dissipation		5	W
PG (AV)	Average gate power dissipation		0.5	W
VGM	Peak gate voltage		10	V
IGM	Peak gate current		2	A
Tj	Junction temperature		-40 ~ +125	°C
Tstg	Storage temperature		-40 ~ +125	°C
—	Weight	Typical value	1.2	g

*1. Gate open.



BCR8CS

MEDIUM POWER USE

NON-INSULATED TYPE, PLANAR PASSIVATION TYPE

ELECTRICAL CHARACTERISTICS

Symbol	Parameter	Test conditions	Limits			Unit	
			Min.	Typ.	Max.		
IDRM	Repetitive peak off-state current	$T_j=125^\circ\text{C}$, V_{DRM} applied	—	—	2.0	mA	
V _{TM}	On-state voltage	$T_c=25^\circ\text{C}$, $I_{\text{TM}}=12\text{A}$, Instantaneous measurement	—	—	1.5	V	
V _{FGT I}	Gate trigger voltage *2	$T_j=25^\circ\text{C}$, $V_D=6\text{V}$, $R_L=6\Omega$, $R_G=330\Omega$	I	—	—	1.5	V
V _{RGT I}			II	—	—	1.5	V
V _{RGT III}			III	—	—	1.5	V
I _{FGT I}	Gate trigger current *2	$T_j=25^\circ\text{C}$, $V_D=6\text{V}$, $R_L=6\Omega$, $R_G=330\Omega$	I	—	—	30*5	mA
I _{RGT I}			II	—	—	30*5	mA
I _{RGT III}			III	—	—	30*5	mA
V _{GD}	Gate non-trigger voltage	$T_j=125^\circ\text{C}$, $V_D=1/2V_{\text{DRM}}$	0.2	—	—	V	
R _{th (j-c)}	Thermal resistance	Junction to case *4	—	—	2.0	$^\circ\text{C}/\text{W}$	
(dv/dt) _c	Critical-rate of rise of off-state commutating voltage		*3	—	—	V/ μs	

*2. Measurement using the gate trigger characteristics measurement circuit.

*3. The critical-rate of rise of the off-state commutating voltage is shown in the table below.

*4. The contact thermal resistance R_{th (c-f)} is 1.0 $^\circ\text{C}/\text{W}$.

*5. High sensitivity (I_{GT}≤20mA) is also available. (IGT item ①)

Voltage class	V _{DRM} (V)	(dv/dt) _c			Test conditions	Commutating voltage and current waveforms (inductive load)
		Symbol	Min.	Unit		
8	400	R	—	V/ μs	1. Junction temperature $T_j=125^\circ\text{C}$ 2. Rate of decay of on-state commutating current $(di/dt)_c=-4\text{A}/\text{ms}$ 3. Peak off-state voltage $V_D=400\text{V}$	
		L	10			
12	600	R	—			
		L	10			

PERFORMANCE CURVES

MAXIMUM ON-STATE CHARACTERISTICS

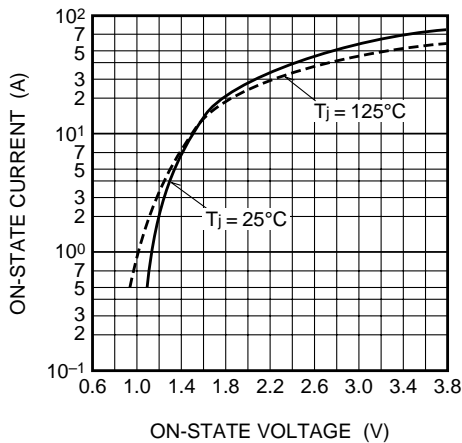

RATED SURGE ON-STATE CURRENT

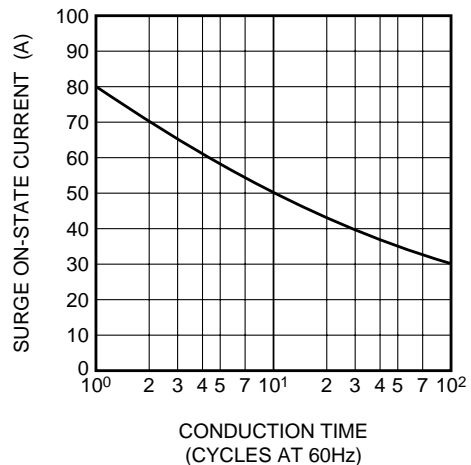

BCR8CS

MEDIUM POWER USE

NON-INSULATED TYPE, PLANAR PASSIVATION TYPE

GATE CHARACTERISTICS

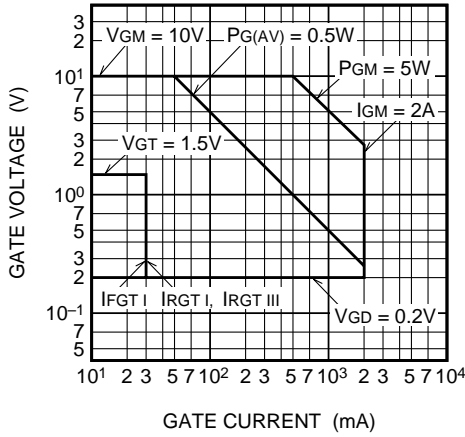

GATE TRIGGER CURRENT VS. JUNCTION TEMPERATURE

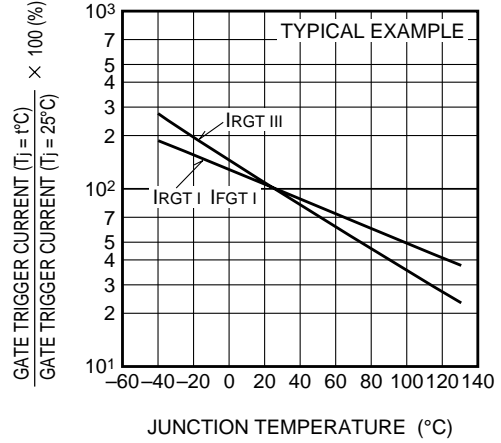

GATE TRIGGER VOLTAGE VS. JUNCTION TEMPERATURE

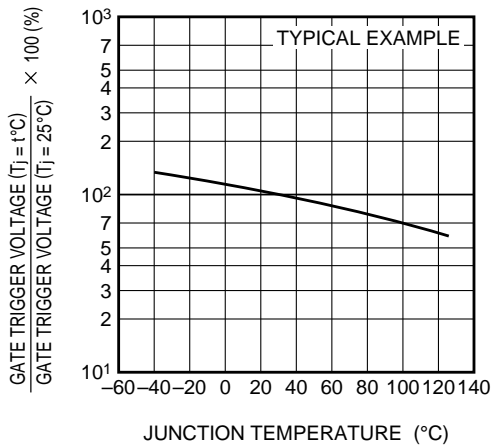

MAXIMUM TRANSIENT THERMAL IMPEDANCE CHARACTERISTICS (JUNCTION TO CASE)

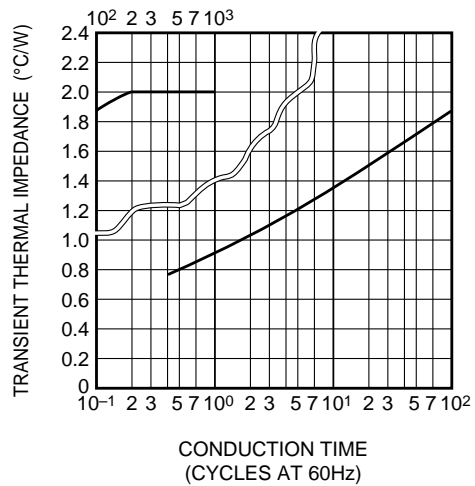

MAXIMUM ON-STATE POWER DISSIPATION

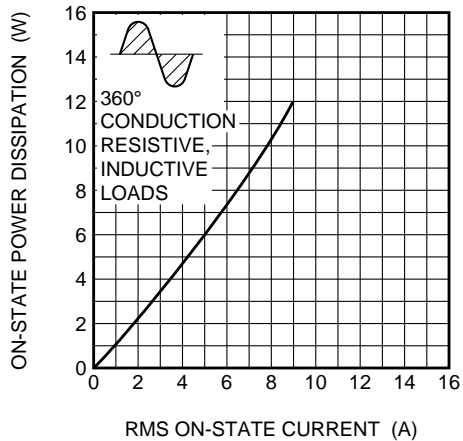

ALLOWABLE CASE TEMPERATURE VS. RMS ON-STATE CURRENT

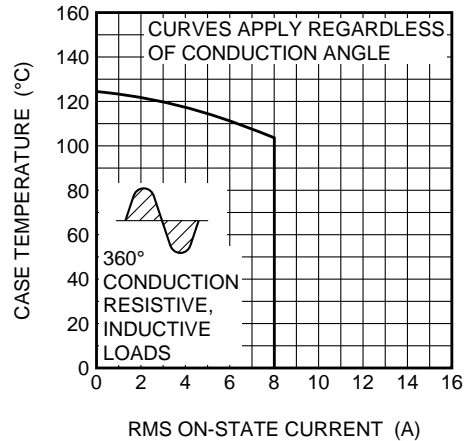

BCR8CS

MEDIUM POWER USE

NON-INSULATED TYPE, PLANAR PASSIVATION TYPE

ALLOWABLE AMBIENT TEMPERATURE VS. RMS ON-STATE CURRENT

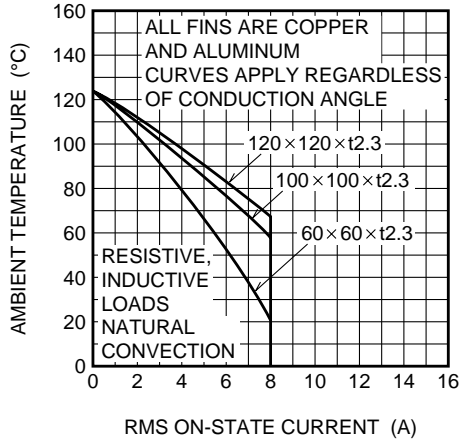

ALLOWABLE AMBIENT TEMPERATURE VS. RMS ON-STATE CURRENT

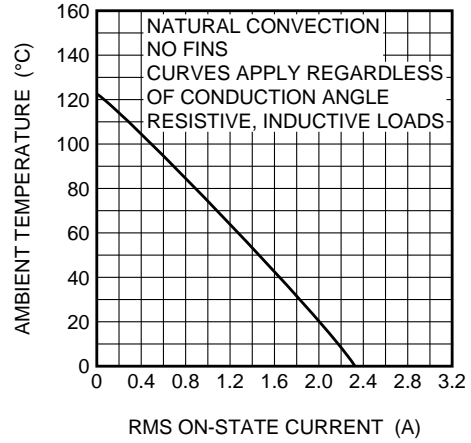

REPETITIVE PEAK OFF-STATE CURRENT VS. JUNCTION TEMPERATURE

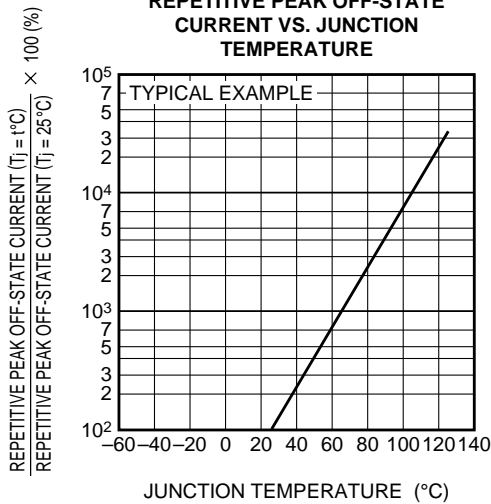

HOLDING CURRENT VS. JUNCTION TEMPERATURE

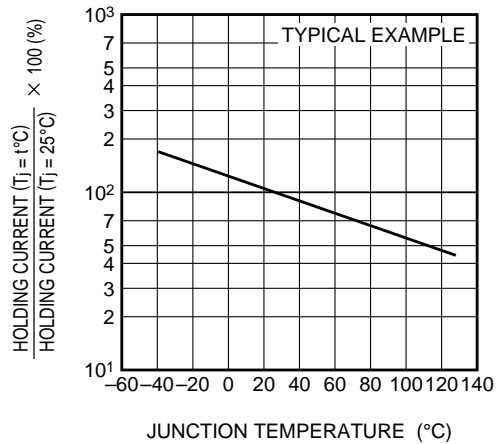

LACHING CURRENT VS. JUNCTION TEMPERATURE

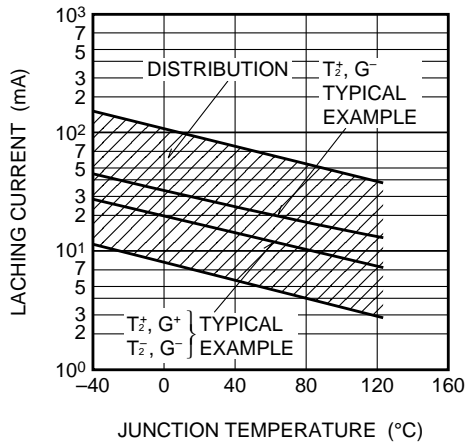

BREAKOVER VOLTAGE VS. JUNCTION TEMPERATURE

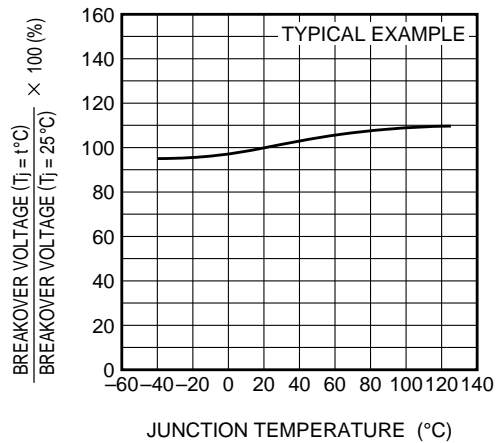

BCR8CS

MEDIUM POWER USE

NON-INSULATED TYPE, PLANAR PASSIVATION TYPE

BREAKOVER VOLTAGE VS. RATE OF RISE OF OFF-STATE VOLTAGE

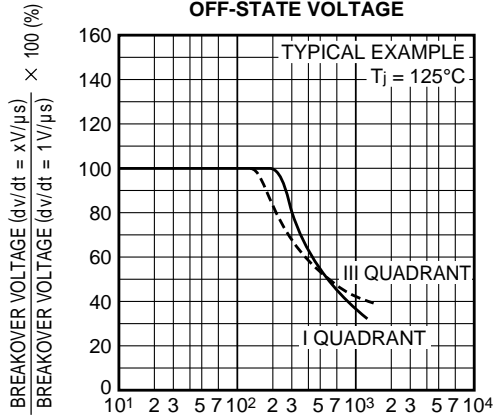

RATE OF RISE OF OFF-STATE VOLTAGE (V/μs)

COMMUTATION CHARACTERISTICS

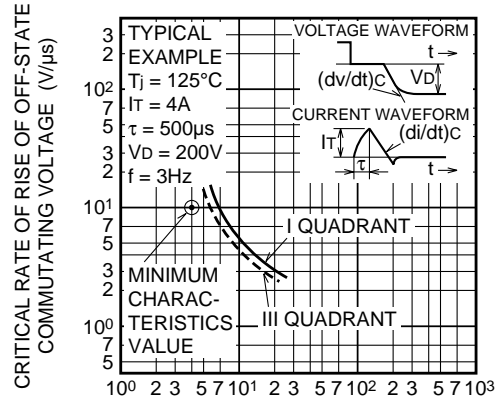

RATE OF DECAY OF ON-STATE COMMUTATING CURRENT (A/ms)

GATE TRIGGER CURRENT VS. GATE CURRENT PULSE WIDTH

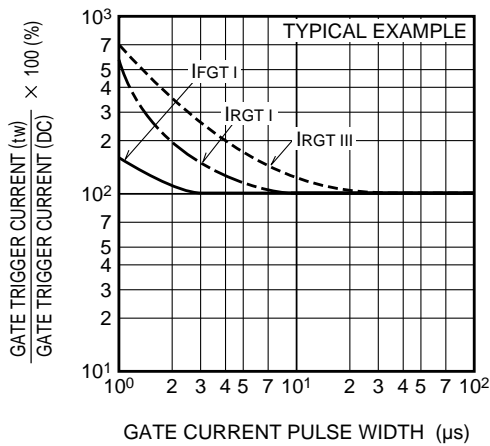

GATE TRIGGER CHARACTERISTICS TEST CIRCUITS

