

# MC74VHC1GT86

## 2-Input Exclusive OR Gate / CMOS Logic Level Shifter with LSTTL-Compatible Inputs

The MC74VHC1GT86 is an advanced high speed CMOS 2-input Exclusive OR gate fabricated with silicon gate CMOS technology. It achieves high speed operation similar to equivalent Bipolar Schottky TTL while maintaining CMOS low power dissipation.

The internal circuit is composed of three stages, including a buffer output which provides high noise immunity and stable output.

The device input is compatible with TTL-type input thresholds and the output has a full 5V CMOS level output swing. The input protection circuitry on this device allows overvoltage tolerance on the input, allowing the device to be used as a logic-level translator from 3.0V CMOS logic to 5.0V CMOS Logic or from 1.8V CMOS logic to 3.0V CMOS Logic while operating at the high-voltage power supply.

The MC74VHC1GT86 input structure provides protection when voltages up to 7V are applied, regardless of the supply voltage. This allows the MC74VHC1GT86 to be used to interface 5V circuits to 3V circuits. The output structures also provide protection when  $V_{CC} = 0V$ . These input and output structures help prevent device destruction caused by supply voltage – input/output voltage mismatch, battery backup, hot insertion, etc.

- High Speed:  $t_{PD} = 4.8ns$  (Typ) at  $V_{CC} = 5V$
- Low Power Dissipation:  $I_{CC} = 2\mu A$  (Max) at  $T_A = 25^\circ C$
- TTL-Compatible Inputs:  $V_{IL} = 0.8V$ ;  $V_{IH} = 2.0V$
- CMOS-Compatible Outputs:  $V_{OH} > 0.8V_{CC}$ ;  $V_{OL} < 0.1V_{CC}$  @Load
- Power Down Protection Provided on Inputs and Outputs
- Balanced Propagation Delays
- Pin and Function Compatible with Other Standard Logic Families
- Latchup Performance Exceeds 300mA
- ESD Performance: HBM > 2000V; MM > 200V, CDM > 1500V

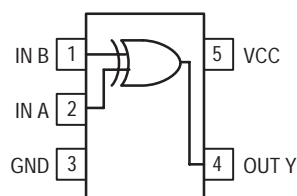
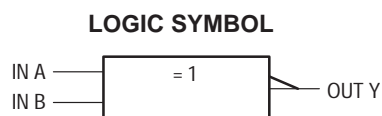
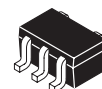

Figure 1. 5-Lead SOT-353 Pinout (Top View)



**ON Semiconductor**  
Formerly a Division of Motorola  
<http://onsemi.com>



SC-88A / SOT-353  
DF SUFFIX  
CASE 419A

### MARKING DIAGRAM

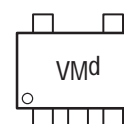

Pin 1  
d = Date Code

PIN ASSIGNMENT	
1	IN B
2	IN A
3	GND
4	OUT Y
5	VCC

### ORDERING INFORMATION

See detailed ordering and shipping information in the package dimensions section on page 4 of this data sheet.

### FUNCTION TABLE

Inputs		Output
A	B	Y
L	L	L
L	H	H
H	L	H
H	H	L

# MC74VHC1GT86

## MAXIMUM RATINGS\*

Characteristics	Symbol	Value	Unit
DC Supply Voltage	$V_{CC}$	-0.5 to +7.0	V
DC Input Voltage	$V_{IN}$	-0.5 to +7.0	V
DC Output Voltage $V_{CC} = 0$ High or Low State	$V_{OUT}$	-0.5 to 7.0 -0.5 to $V_{CC} + 0.5$	V
Input Diode Current	$I_{IK}$	-20	mA
Output Diode Current ( $V_{OUT} < GND$ ; $V_{OUT} > V_{CC}$ )	$I_{OK}$	+20	mA
DC Output Current, per Pin	$I_{OUT}$	+25	mA
DC Supply Current, $V_{CC}$ and GND	$I_{CC}$	+50	mA
Power dissipation in still air, SC-88A †	$P_D$	200	mW
Lead temperature, 1 mm from case for 10 s	$T_L$	260	°C
Storage temperature	$T_{stg}$	-65 to +150	°C

\* Maximum Ratings are those values beyond which damage to the device may occur. Exposure to these conditions or conditions beyond those indicated may adversely affect device reliability. Functional operation under absolute-maximum-rated conditions is not implied. Functional operation should be restricted to the Recommended Operating Conditions.

† Derating — SC-88A Package: -3 mW/°C from 65° to 125°C

## RECOMMENDED OPERATING CONDITIONS

Characteristics	Symbol	Min	Max	Unit
DC Supply Voltage	$V_{CC}$	4.5	5.5	V
DC Input Voltage	$V_{IN}$	0.0	5.5	V
DC Output Voltage $V_{CC} = 0$ High or Low State	$V_{OUT}$	0.0 0.0	5.5 $V_{CC}$	V
Operating Temperature Range	$T_A$	-55	+85	°C
Input Rise and Fall Time $V_{CC} = 3.3V \pm 0.3V$ $V_{CC} = 5.0V \pm 0.5V$	$t_r, t_f$	0 0	100 20	ns/V

# MC74VHC1GT86

## DC ELECTRICAL CHARACTERISTICS

Symbol	Parameter	Test Conditions	V <sub>CC</sub> (V)	T <sub>A</sub> = 25°C			T <sub>A</sub> ≤ 85°C		T <sub>A</sub> ≤ 125°C		Unit
				Min	Typ	Max	Min	Max	Min	Max	
V <sub>IH</sub>	Minimum High-Level Input Voltage		3.0 4.5 5.5	1.2 2.0 2.0			1.2 2.0 2.0		1.2 2.0 2.0	V	
V <sub>IL</sub>	Maximum Low-Level Input Voltage		3.0 4.5 5.5			0.53 0.8 0.8		0.53 0.8 0.8		0.53 0.8 0.8	V
V <sub>OH</sub>	Minimum High-Level Output Voltage V <sub>IN</sub> = V <sub>IH</sub> or V <sub>IL</sub>	V <sub>IN</sub> = V <sub>IH</sub> or V <sub>IL</sub> I <sub>OH</sub> = -50μA	3.0 4.5	2.9 4.4	3.0 4.5		2.9 4.4		2.9 4.4	V	
		V <sub>IN</sub> = V <sub>IH</sub> or V <sub>IL</sub> I <sub>OH</sub> = -4mA I <sub>OH</sub> = -8mA	3.0 4.5	2.58 3.94			2.48 3.80		2.34 3.66	V	
V <sub>OL</sub>	Maximum Low-Level Output Voltage V <sub>IN</sub> = V <sub>IH</sub> or V <sub>IL</sub>	V <sub>IN</sub> = V <sub>IH</sub> or V <sub>IL</sub> I <sub>OL</sub> = 50μA	3.0 4.5		0.0 0.0	0.1 0.1		0.1 0.1		0.1 0.1	V
		V <sub>IN</sub> = V <sub>IH</sub> or V <sub>IL</sub> I <sub>OL</sub> = 4mA I <sub>OL</sub> = 8mA	3.0 4.5				0.36 0.36		0.44 0.44		0.52 0.52
I <sub>IN</sub>	Maximum Input Leakage Current	V <sub>IN</sub> = 5.5V or GND	0 to 5.5			±0.1		±1.0		±1.0	μA
I <sub>CC</sub>	Maximum Quiescent Supply Current	V <sub>IN</sub> = V <sub>CC</sub> or GND	5.5			2.0		20		40	μA
I <sub>CCT</sub>	Quiescent Supply Current	Input: V <sub>IN</sub> = 3.4V	5.5			1.35		1.50		1.65	mA
I <sub>OPD</sub>	Output Leakage Current	V <sub>OUT</sub> = 5.5V	0.0			0.5		5.0		10	μA

## AC ELECTRICAL CHARACTERISTICS (C<sub>load</sub> = 50 pF, Input t<sub>r</sub> = t<sub>f</sub> = 3.0ns)

Symbol	Parameter	Test Conditions	T <sub>A</sub> = 25°C			T <sub>A</sub> ≤ 85°C		T <sub>A</sub> ≤ 125°C		Unit
			Min	Typ	Max	Min	Max	Min	Max	
t <sub>PLH</sub> , t <sub>PHL</sub>	Maximum Propagation Delay, Input A or B to Y	V <sub>CC</sub> = 3.0 ± 0.3V C <sub>L</sub> = 15 pF C <sub>L</sub> = 50 pF		5.0 6.2	11.0 14.5		13.0 16.5		15.5 19.5	ns
		V <sub>CC</sub> = 5.0 ± 0.5V C <sub>L</sub> = 15 pF C <sub>L</sub> = 50 pF		3.1 4.2	6.8 8.8		8.0 10.0		10.0 12.0	
C <sub>IN</sub>	Maximum Input Capacitance			5.5	10		10		10	pF

C <sub>PD</sub>	Power Dissipation Capacitance (Note 1.)	<b>Typical @ 25°C, V<sub>CC</sub> = 5.0V</b>	pF
		11	

1. C<sub>PD</sub> is defined as the value of the internal equivalent capacitance which is calculated from the operating current consumption without load. Average operating current can be obtained by the equation: I<sub>CC(OPR)</sub> = C<sub>PD</sub> • V<sub>CC</sub> • f<sub>in</sub> + I<sub>CC</sub>. C<sub>PD</sub> is used to determine the no-load dynamic power consumption; P<sub>D</sub> = C<sub>PD</sub> • V<sub>CC</sub><sup>2</sup> • f<sub>in</sub> + I<sub>CC</sub> • V<sub>CC</sub>.

# MC74VHC1GT86

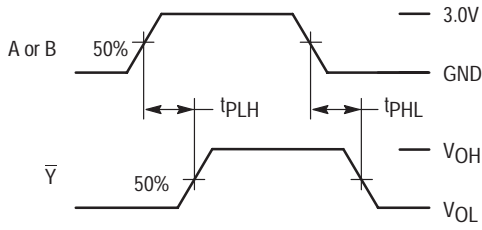
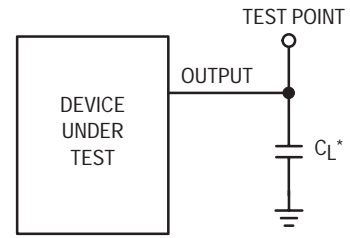

Figure 2. Switching Waveforms



\*Includes all probe and jig capacitance

Figure 3. Test Circuit

## DEVICE ORDERING INFORMATION

Device Order Number	Device Nomenclature							Package Type	Tape and Reel Size
	Circuit Indicator	Temp Range Identifier	Tech- nology	Input Type	Device Function	Package Suffix	Tape & Reel Suffix		
MC74VHC1GT86DFT1	MC	74	VHC1G	T	86	DF	T1	SC-88A/ SOT-353	7-Inch/3000 Unit

## PACKAGE DIMENSIONS

SC-88A / SOT-353  
DF SUFFIX  
5-LEAD PACKAGE  
CASE 419A-01  
ISSUE B

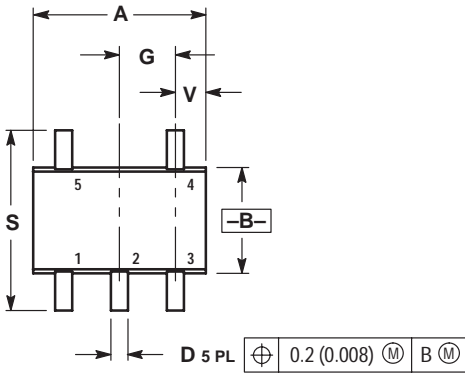

- NOTES:  
1. DIMENSIONING AND TOLERANCING PER ANSI Y14.5M, 1982.  
2. CONTROLLING DIMENSION: MM.

DIM	INCHES		MILLIMETERS	
	MIN	MAX	MIN	MAX
A	0.071	0.087	1.80	2.20
B	0.045	0.053	1.15	1.35
C	0.031	0.043	0.80	1.10
D	0.004	0.012	0.10	0.30
G	0.026 BSC		0.65 BSC	
H	—	0.004	—	0.10
J	0.004	0.010	0.10	0.25
K	0.004	0.012	0.10	0.30
N	0.008 REF		0.20 REF	
S	0.079	0.087	2.00	2.20
V	0.012	0.016	0.30	0.40

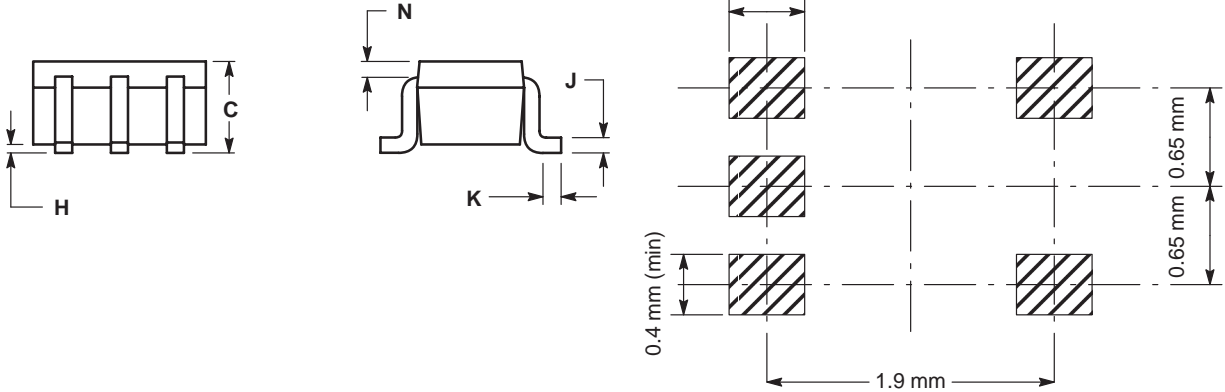

# MC74VHC1GT86

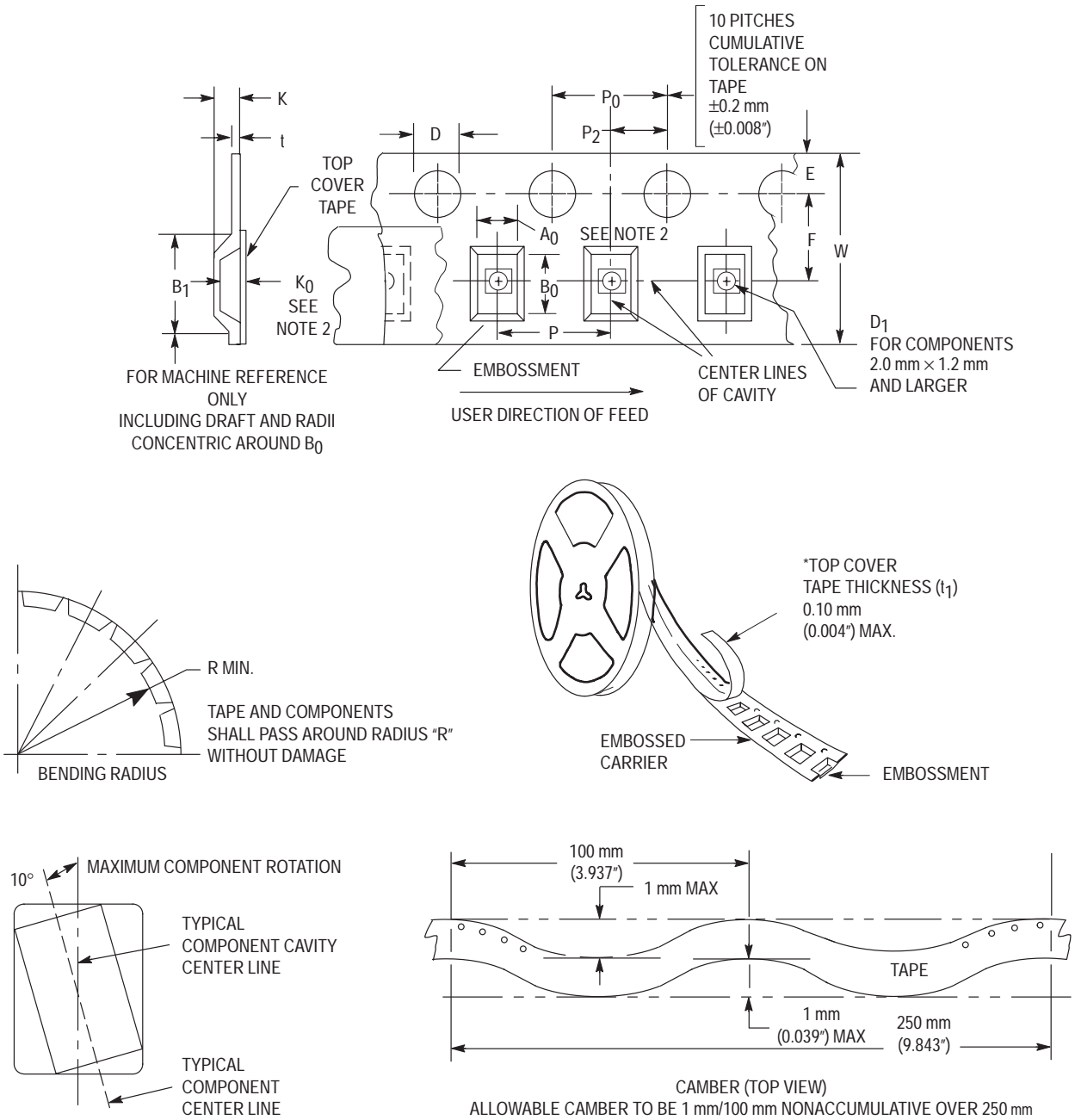

**Figure 4. Carrier Tape Specifications**

**EMBOSSED CARRIER DIMENSIONS** (See Notes 1 and 2)

Tape Size	B <sub>1</sub> Max	D	D <sub>1</sub>	E	F	K	P	P <sub>0</sub>	P <sub>2</sub>	R	T	W
8 mm	4.35 mm (0.171")	1.5 +0.1/-0.0 mm (0.059 +0.004/-0.0")	1.0 mm Min (0.039")	1.75 ±0.1 mm (0.069 ±0.004")	3.5 ±0.5 mm (1.38 ±0.002")	2.4 mm (0.094")	4.0 ±0.10 mm (0.157 ±0.004")	4.0 ±0.1 mm (0.156 ±0.004")	2.0 ±0.1 mm (0.079 ±0.002")	25 mm (0.98")	0.3 ±0.05 mm (0.01 +0.0038/-0.0002")	8.0 ±0.3 mm (0.315 ±0.012")

1. Metric Dimensions Govern—English are in parentheses for reference only.
2. A<sub>0</sub>, B<sub>0</sub>, and K<sub>0</sub> are determined by component size. The clearance between the components and the cavity must be within 0.05 mm min to 0.50 mm max. The component cannot rotate more than 10° within the determined cavity

# MC74VHC1GT86

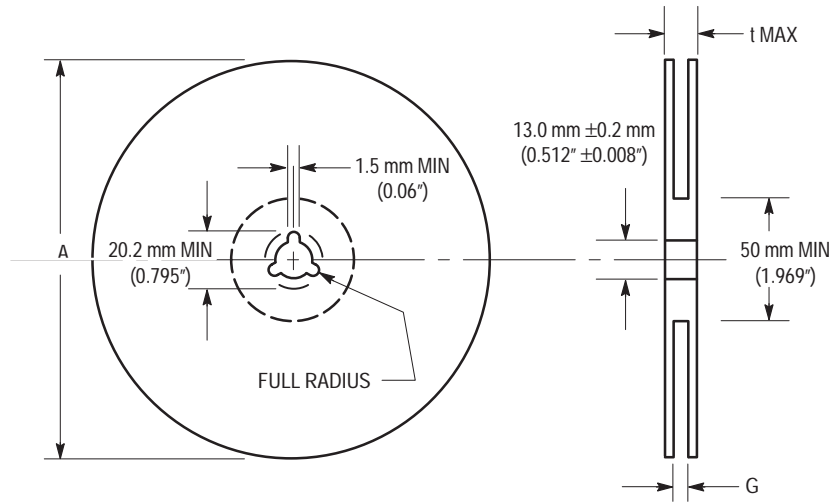

Figure 5. Reel Dimensions

## REEL DIMENSIONS

Tape Size	A Max	G	t Max
8 mm	330 mm (13")	8.400 mm, +1.5 mm, -0.0 (0.33", +0.059", -0.00)	14.4 mm (0.56")

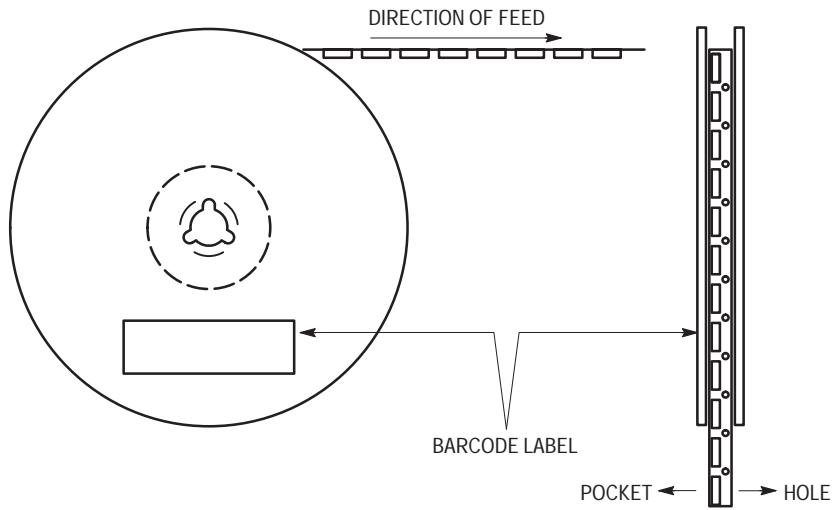
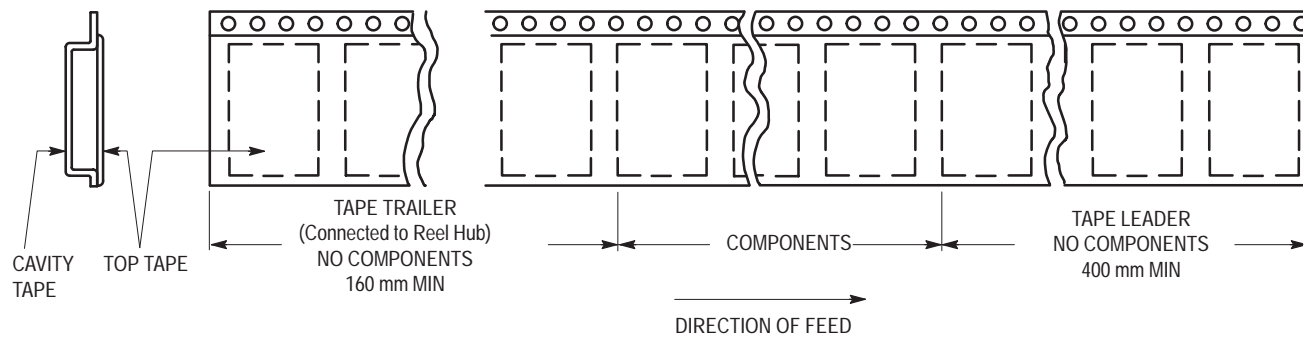
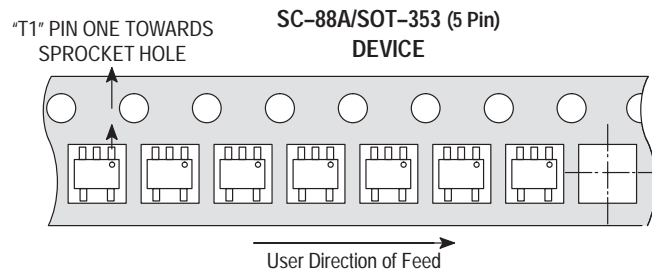

Figure 6. Reel Winding Direction

# MC74VHC1GT86



**Figure 7. Tape Ends for Finished Goods**



**Figure 8. Reel Configuration**

# MC74VHC1GT86

**ON Semiconductor** and  are trademarks of Semiconductor Components Industries, LLC (SCILLC). SCILLC reserves the right to make changes without further notice to any products herein. SCILLC makes no warranty, representation or guarantee regarding the suitability of its products for any particular purpose, nor does SCILLC assume any liability arising out of the application or use of any product or circuit, and specifically disclaims any and all liability, including without limitation special, consequential or incidental damages. "Typical" parameters which may be provided in SCILLC data sheets and/or specifications can and do vary in different applications and actual performance may vary over time. All operating parameters, including "Typicals" must be validated for each customer application by customer's technical experts. SCILLC does not convey any license under its patent rights nor the rights of others. SCILLC products are not designed, intended, or authorized for use as components in systems intended for surgical implant into the body, or other applications intended to support or sustain life, or for any other application in which the failure of the SCILLC product could create a situation where personal injury or death may occur. Should Buyer purchase or use SCILLC products for any such unintended or unauthorized application, Buyer shall indemnify and hold SCILLC and its officers, employees, subsidiaries, affiliates, and distributors harmless against all claims, costs, damages, and expenses, and reasonable attorney fees arising out of, directly or indirectly, any claim of personal injury or death associated with such unintended or unauthorized use, even if such claim alleges that SCILLC was negligent regarding the design or manufacture of the part. SCILLC is an Equal Opportunity/Affirmative Action Employer.

## PUBLICATION ORDERING INFORMATION

### USA/EUROPE Literature Fulfillment:

Literature Distribution Center for ON Semiconductor  
P.O. Box 5163, Denver, Colorado 80217 USA  
**Phone:** 303-675-2175 or 800-344-3860 Toll Free USA/Canada  
**Fax:** 303-675-2176 or 800-344-3867 Toll Free USA/Canada  
**Email:** ONlit@hibbertco.com

**Fax Response Line\*:** 303-675-2167  
800-344-3810 Toll Free USA/Canada  
\*To receive a Fax of our publications

**N. America Technical Support:** 800-282-9855 Toll Free USA/Canada

**ASIA/PACIFIC:** LDC for ON Semiconductor – Asia Support  
**Phone:** 303-675-2121 (Tue-Fri 9:00am to 1:00pm, Hong Kong Time)  
**Email:** ONlit-asia@hibbertco.com

**JAPAN:** ON Semiconductor, Japan Customer Focus Center  
4-32-1 Nishi-Gotanda, Shinagawa-ku, Tokyo, Japan 141-8549  
**Phone:** 81-3-5487-8345  
**Email:** r14153@onsemi.com

**ON Semiconductor Website:** <http://onsemi.com>

For additional information, please contact your local Sales Representative.