

High Voltage Transistors

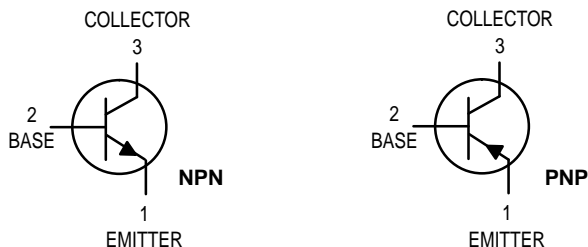

NPN
2N6515
2N6517
PNP
2N6519
2N6520

Voltage and current are negative
for PNP transistors

MAXIMUM RATINGS

Rating	Symbol	2N6515	2N6519	2N6517 2N6520	Unit
Collector–Emitter Voltage	V_{CEO}	250	300	350	Vdc
Collector–Base Voltage	V_{CBO}	250	300	350	Vdc
Emitter–Base Voltage 2N6515, 2N6516, 2N6517 2N6519, 2N6520	V_{EBO}	6.0 5.0			Vdc
Base Current	I_B	250			mAdc
Collector Current — Continuous	I_C	500			mAdc
Total Device Dissipation @ $T_A = 25^\circ\text{C}$ Derate above 25°C	P_D	625 5.0			mW mW/ $^\circ\text{C}$
Total Device Dissipation @ $T_C = 25^\circ\text{C}$ Derate above 25°C	P_D	1.5 12			Watts mW/ $^\circ\text{C}$
Operating and Storage Junction Temperature Range	T_J, T_{stg}	–55 to +150			$^\circ\text{C}$

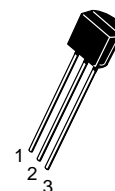

CASE 29–04, STYLE 1
TO–92 (TO–226AA)

THERMAL CHARACTERISTICS

Characteristic	Symbol	Max	Unit
Thermal Resistance, Junction to Ambient	$R_{\theta JA}$	200	$^\circ\text{C}/\text{W}$
Thermal Resistance, Junction to Case	$R_{\theta JC}$	83.3	$^\circ\text{C}/\text{W}$

ELECTRICAL CHARACTERISTICS ($T_A = 25^\circ\text{C}$ unless otherwise noted)

Characteristic	Symbol	Min	Max	Unit
----------------	--------	-----	-----	------

OFF CHARACTERISTICS

Collector–Emitter Breakdown Voltage ⁽¹⁾ ($I_C = 1.0$ mAdc, $I_B = 0$)	$V_{(BR)CEO}$	250 300 350	— — —	Vdc
Collector–Base Breakdown Voltage ($I_C = 100$ μ Adc, $I_E = 0$)	$V_{(BR)CBO}$	250 300 350	— — —	Vdc
Emitter–Base Breakdown Voltage ($I_E = 10$ μ Adc, $I_C = 0$)	$V_{(BR)EBO}$	6.0 5.0	— —	Vdc

1. Pulse Test: Pulse Width ≤ 300 μs , Duty Cycle $\leq 2.0\%$.

NPN 2N6515 2N6517 PNP 2N6519 2N6520
ELECTRICAL CHARACTERISTICS ($T_A = 25^\circ\text{C}$ unless otherwise noted) (Continued)

Characteristic	Symbol	Min	Max	Unit
OFF CHARACTERISTICS (Continued)				
Collector Cutoff Current ($V_{CB} = 150\text{ Vdc}$, $I_E = 0$) ($V_{CB} = 200\text{ Vdc}$, $I_E = 0$) ($V_{CB} = 250\text{ Vdc}$, $I_E = 0$)	I_{CBO}	—	50	nAdc
			50	
			50	
Emitter Cutoff Current ($V_{EB} = 5.0\text{ Vdc}$, $I_C = 0$) ($V_{EB} = 4.0\text{ Vdc}$, $I_C = 0$)	I_{EBO}	—	50	nAdc
			50	

ON CHARACTERISTICS⁽¹⁾

DC Current Gain ($I_C = 1.0\text{ mAdc}$, $V_{CE} = 10\text{ Vdc}$)	h_{FE}	35	—	—
		30	—	
		20	—	
($I_C = 10\text{ mAdc}$, $V_{CE} = 10\text{ Vdc}$)		50	—	
		45	—	
		30	—	
($I_C = 30\text{ mAdc}$, $V_{CE} = 10\text{ Vdc}$)		50	300	
		45	270	
		30	200	
($I_C = 50\text{ mAdc}$, $V_{CE} = 10\text{ Vdc}$)		45	220	
		40	200	
		20	200	
($I_C = 100\text{ mAdc}$, $V_{CE} = 10\text{ Vdc}$)		25	—	
		20	—	
		15	—	
Collector–Emitter Saturation Voltage ($I_C = 10\text{ mAdc}$, $I_B = 1.0\text{ mAdc}$) ($I_C = 20\text{ mAdc}$, $I_B = 2.0\text{ mAdc}$) ($I_C = 30\text{ mAdc}$, $I_B = 3.0\text{ mAdc}$) ($I_C = 50\text{ mAdc}$, $I_B = 5.0\text{ mAdc}$)	$V_{CE(sat)}$	—	0.30	Vdc
			0.35	
			0.50	
			1.0	
Base–Emitter Saturation Voltage ($I_C = 10\text{ mAdc}$, $I_B = 1.0\text{ mAdc}$) ($I_C = 20\text{ mAdc}$, $I_B = 2.0\text{ mAdc}$) ($I_C = 30\text{ mAdc}$, $I_B = 3.0\text{ mAdc}$)	$V_{BE(sat)}$	—	0.75	Vdc
			0.85	
			0.90	
Base–Emitter On Voltage ($I_C = 100\text{ mAdc}$, $V_{CE} = 10\text{ Vdc}$)	$V_{BE(on)}$	—	2.0	Vdc

SMALL–SIGNAL CHARACTERISTICS

Current–Gain — Bandwidth Product ⁽¹⁾ ($I_C = 10\text{ mAdc}$, $V_{CE} = 20\text{ Vdc}$, $f = 20\text{ MHz}$)	f_T	40	200	MHz
Collector–Base Capacitance ($V_{CB} = 20\text{ Vdc}$, $I_E = 0$, $f = 1.0\text{ MHz}$)	C_{cb}	—	6.0	pF
Emitter–Base Capacitance ($V_{EB} = 0.5\text{ Vdc}$, $I_C = 0$, $f = 1.0\text{ MHz}$)	C_{eb}	—	80	pF
			100	

SWITCHING CHARACTERISTICS

Turn–On Time ($V_{CC} = 100\text{ Vdc}$, $V_{BE(off)} = 2.0\text{ Vdc}$, $I_C = 50\text{ mAdc}$, $I_{B1} = 10\text{ mAdc}$)	t_{on}	—	200	μs
Turn–Off Time ($V_{CC} = 100\text{ Vdc}$, $I_C = 50\text{ mAdc}$, $I_{B1} = I_{B2} = 10\text{ mAdc}$)	t_{off}	—	3.5	μs

1. Pulse Test: Pulse Width $\leq 300\ \mu\text{s}$, Duty Cycle $\leq 2.0\%$.

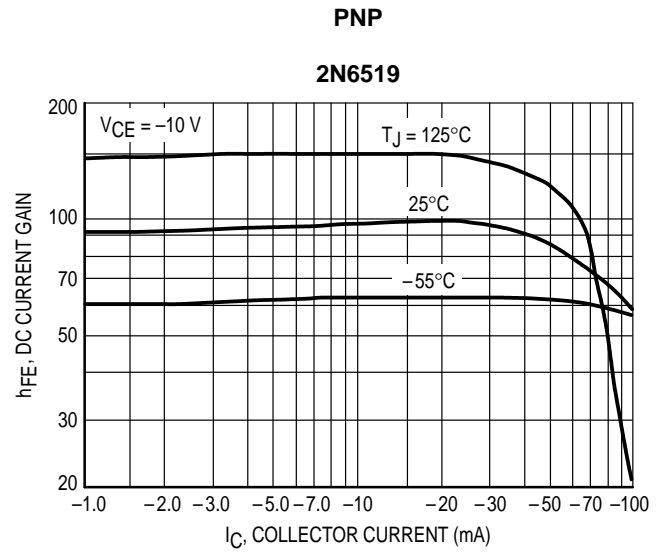
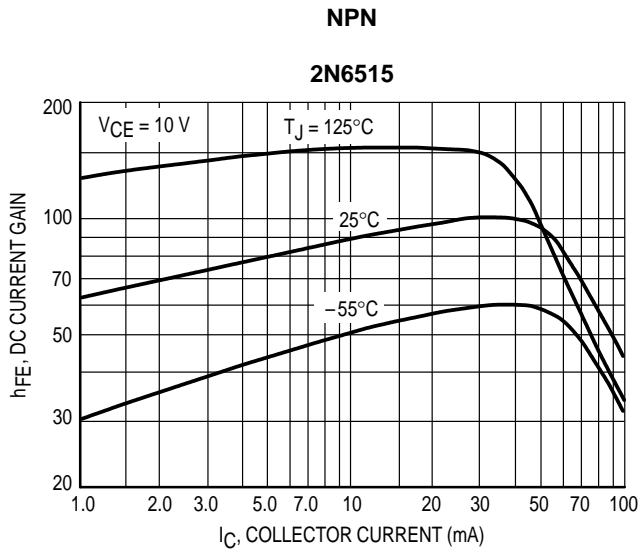

Figure 1. DC Current Gain

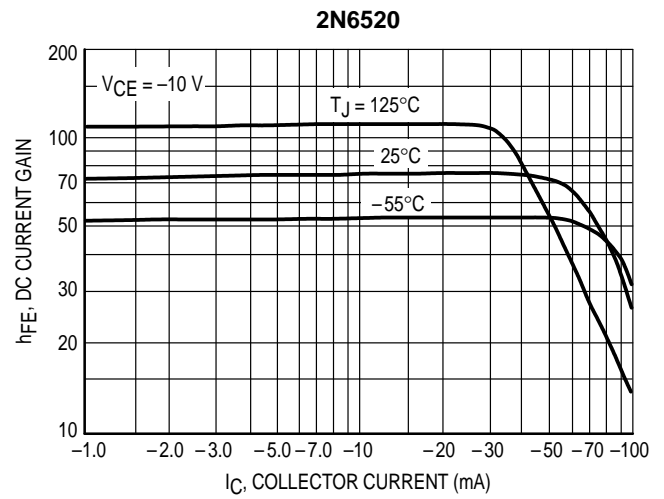
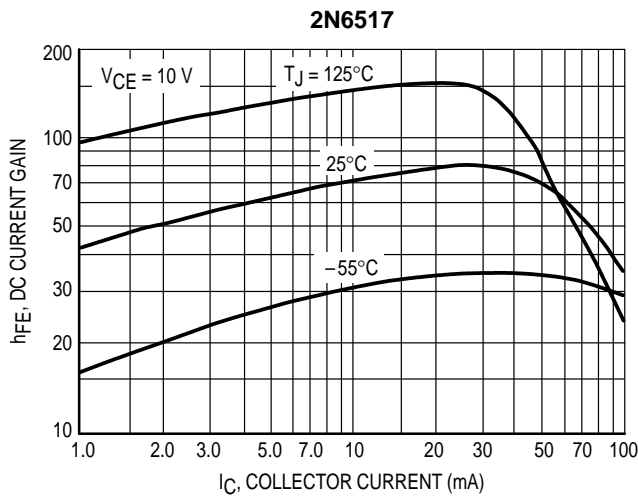

Figure 2. DC Current Gain

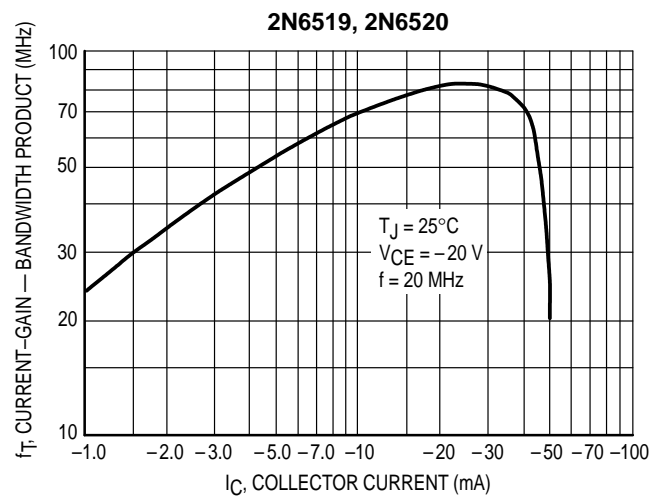
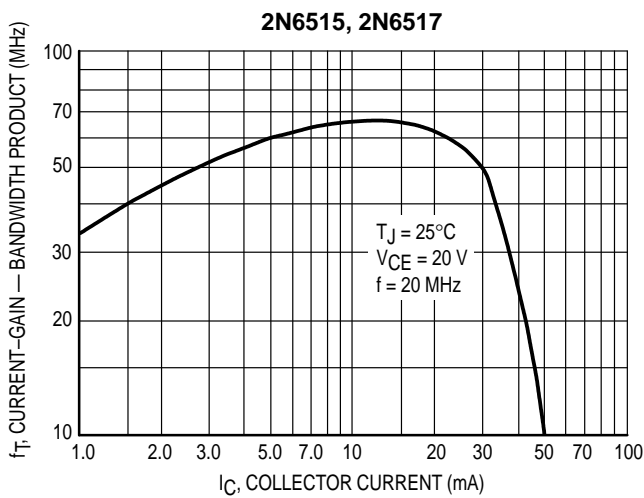
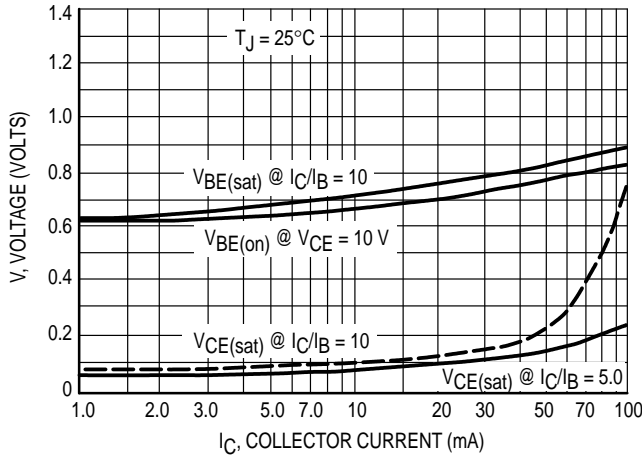

Figure 3. Current-Gain — Bandwidth Product

NPN

2N6515, 2N6517



PNP

2N6519, 2N6520

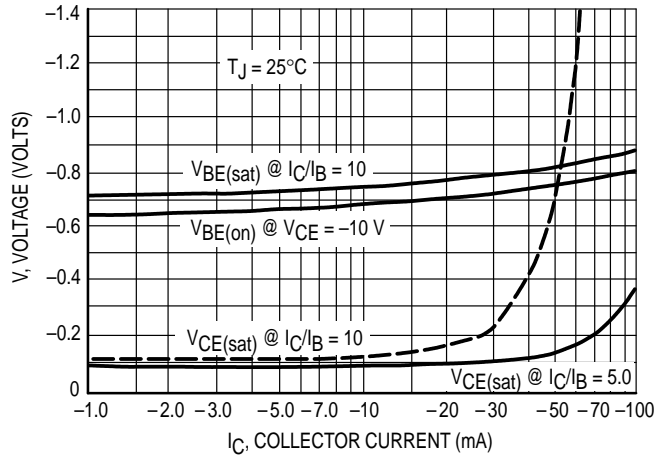
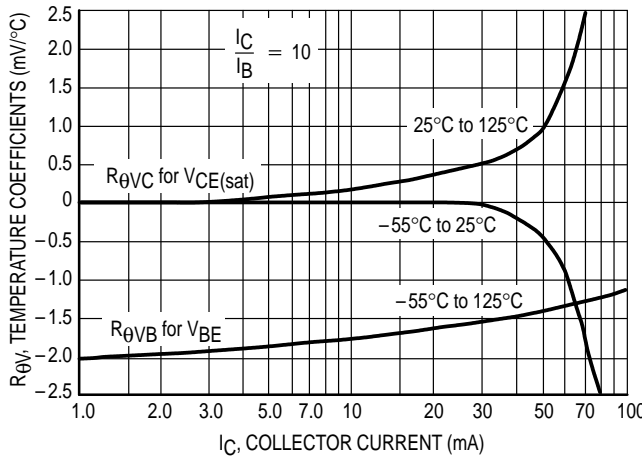

Figure 4. "On" Voltages

2N6515, 2N6517



2N6519, 2N6520

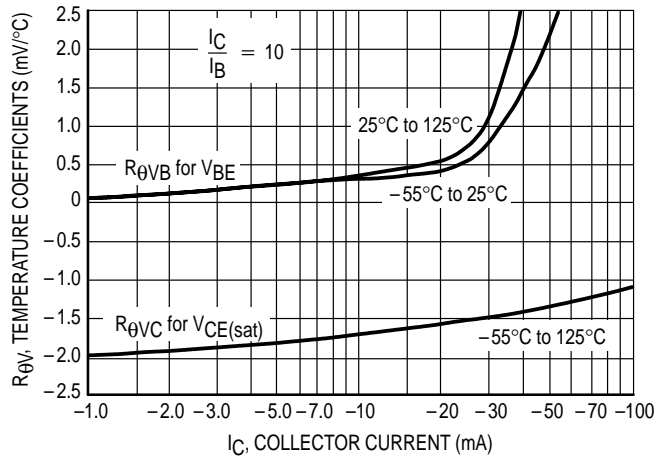
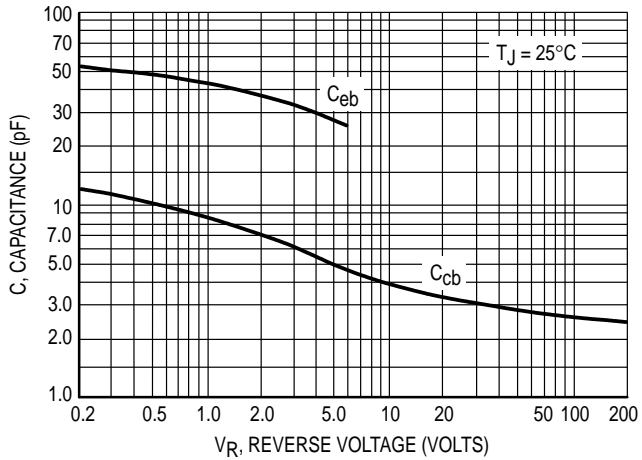

Figure 5. Temperature Coefficients

2N6515, 2N6517



2N6519, 2N6520

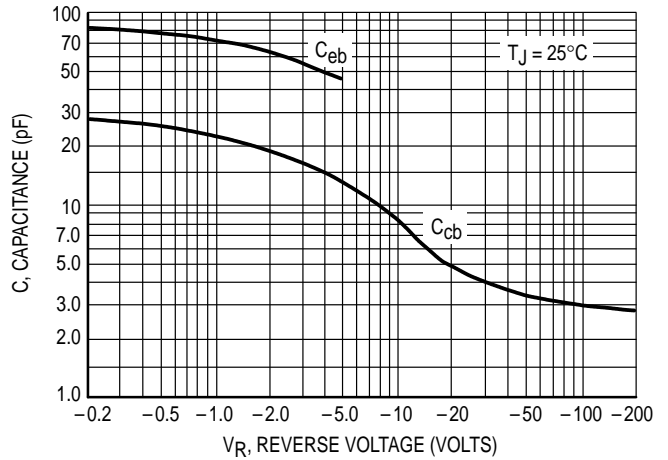

Figure 6. Capacitance

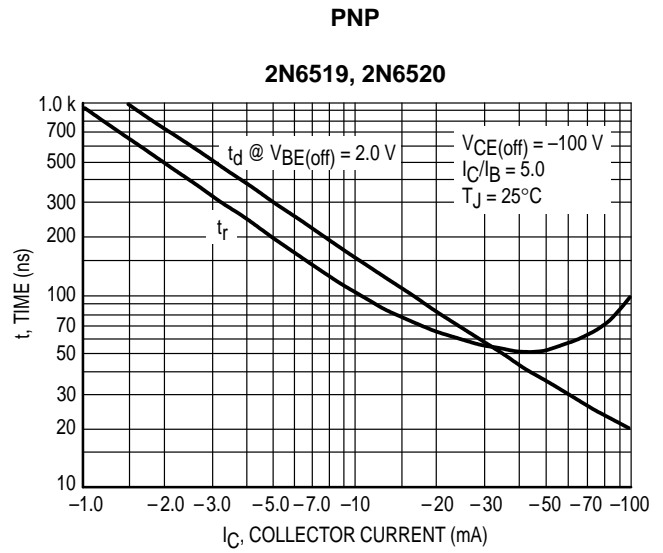
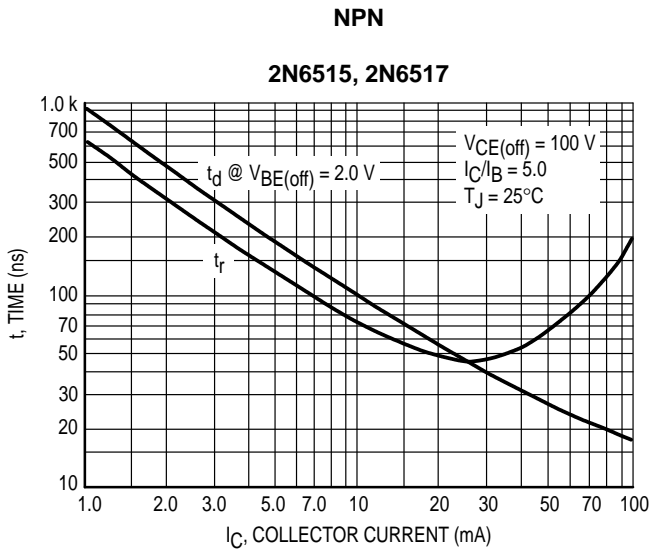

Figure 7. Turn-On Time

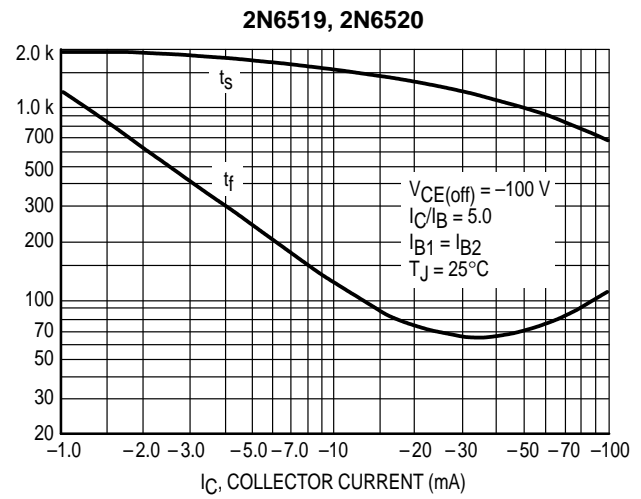
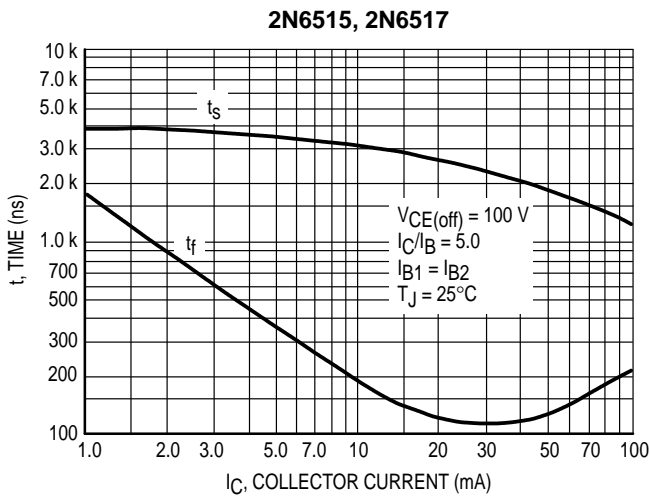

Figure 8. Turn-Off Time

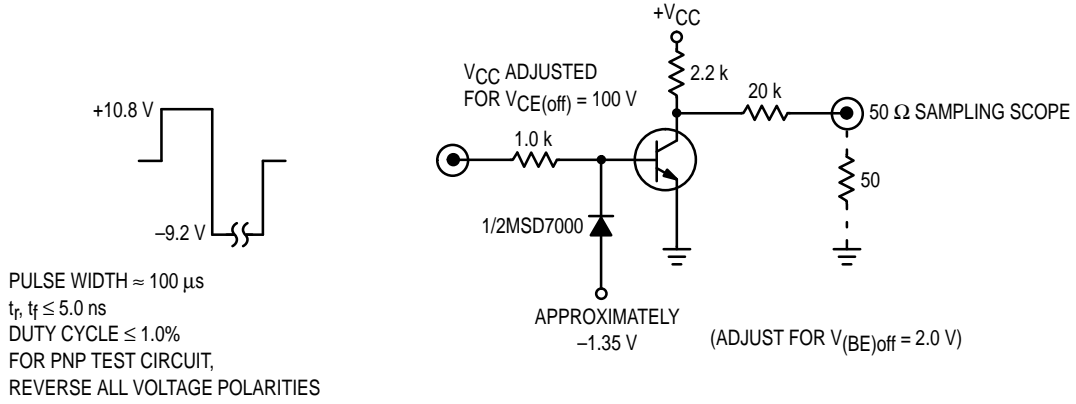

Figure 9. Switching Time Test Circuit

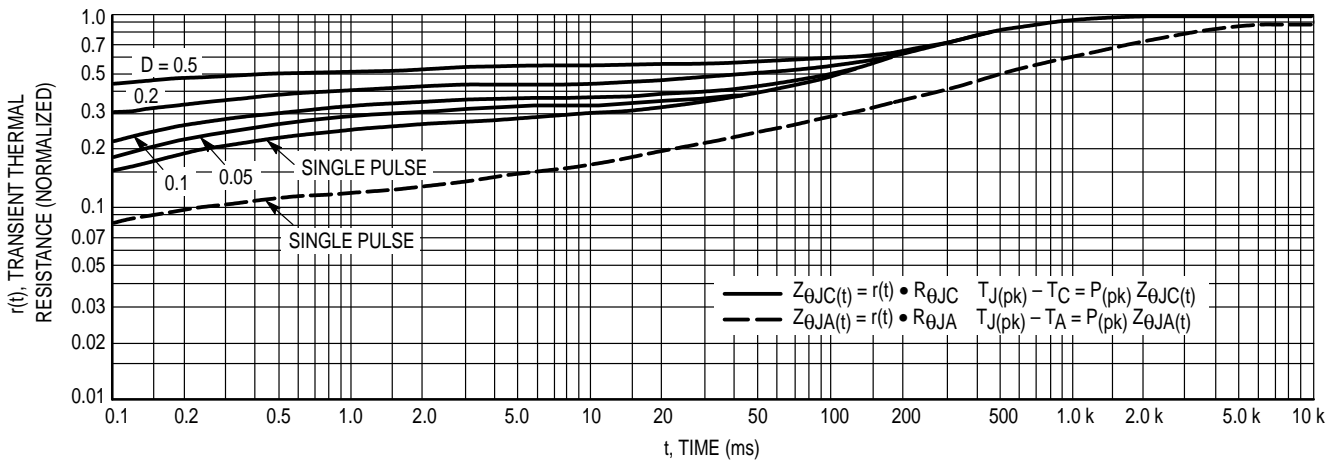

Figure 10. Thermal Response

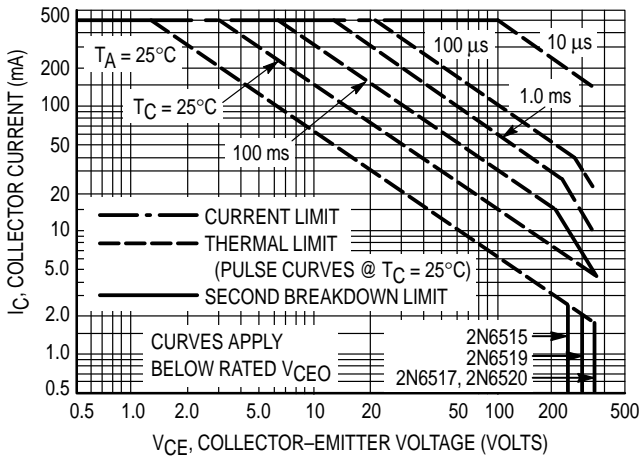
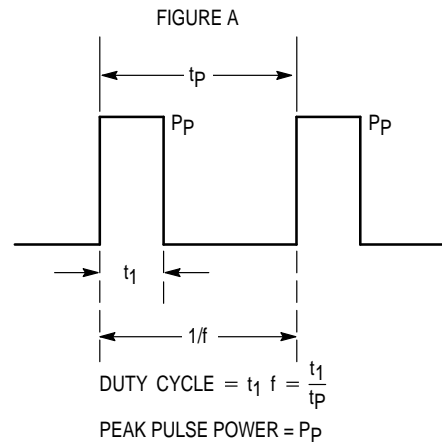
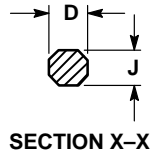
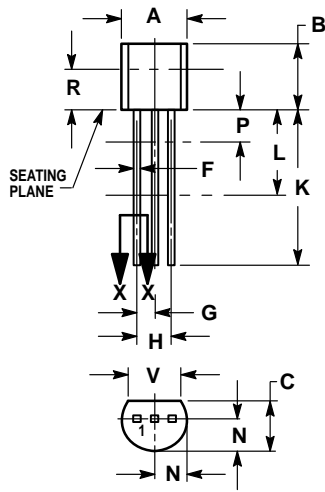

Figure 11. Active Region Safe Operating Area



Design Note: Use of Transient Thermal Resistance Data

PACKAGE DIMENSIONS



**CASE 029-04
(TO-226AA)
ISSUE AD**

NOTES:

1. DIMENSIONING AND TOLERANCING PER ANSI Y14.5M, 1982.
2. CONTROLLING DIMENSION: INCH.
3. CONTOUR OF PACKAGE BEYOND DIMENSION R IS UNCONTROLLED.
4. DIMENSION F APPLIES BETWEEN P AND L. DIMENSION D AND J APPLY BETWEEN L AND K. MINIMUM LEAD DIMENSION IS UNCONTROLLED IN P AND BEYOND DIMENSION K MINIMUM.

DIM	INCHES		MILLIMETERS	
	MIN	MAX	MIN	MAX
A	0.175	0.205	4.45	5.20
B	0.170	0.210	4.32	5.33
C	0.125	0.165	3.18	4.19
D	0.016	0.022	0.41	0.55
F	0.016	0.019	0.41	0.48
G	0.045	0.055	1.15	1.39
H	0.095	0.105	2.42	2.66
J	0.015	0.020	0.39	0.50
K	0.500	—	12.70	—
L	0.250	—	6.35	—
N	0.080	0.105	2.04	2.66
P	—	0.100	—	2.54
R	0.115	—	2.93	—
V	0.135	—	3.43	—

STYLE 1:

- PIN 1. EMITTER
2. BASE
3. COLLECTOR

Motorola reserves the right to make changes without further notice to any products herein. Motorola makes no warranty, representation or guarantee regarding the suitability of its products for any particular purpose, nor does Motorola assume any liability arising out of the application or use of any product or circuit, and specifically disclaims any and all liability, including without limitation consequential or incidental damages. "Typical" parameters which may be provided in Motorola data sheets and/or specifications can and do vary in different applications and actual performance may vary over time. All operating parameters, including "Typicals" must be validated for each customer application by customer's technical experts. Motorola does not convey any license under its patent rights nor the rights of others. Motorola products are not designed, intended, or authorized for use as components in systems intended for surgical implant into the body, or other applications intended to support or sustain life, or for any other application in which the failure of the Motorola product could create a situation where personal injury or death may occur. Should Buyer purchase or use Motorola products for any such unintended or unauthorized application, Buyer shall indemnify and hold Motorola and its officers, employees, subsidiaries, affiliates, and distributors harmless against all claims, costs, damages, and expenses, and reasonable attorney fees arising out of, directly or indirectly, any claim of personal injury or death associated with such unintended or unauthorized use, even if such claim alleges that Motorola was negligent regarding the design or manufacture of the part. Motorola and  are registered trademarks of Motorola, Inc. Motorola, Inc. is an Equal Opportunity/Affirmative Action Employer.

Mfax is a trademark of Motorola, Inc.

How to reach us:

USA/EUROPE/Locations Not Listed: Motorola Literature Distribution;
P.O. Box 5405, Denver, Colorado 80217. 303-675-2140 or 1-800-441-2447

JAPAN: Nippon Motorola Ltd.: SPD, Strategic Planning Office, 4-32-1,
Nishi-Gotanda, Shinagawa-ku, Tokyo 141, Japan. 81-3-5487-8488

Mfax™: RMFAX0@email.sps.mot.com – TOUCHTONE 602-244-6609
– US & Canada ONLY 1-800-774-1848

ASIA/PACIFIC: Motorola Semiconductors H.K. Ltd.; 8B Tai Ping Industrial Park,
51 Ting Kok Road, Tai Po, N.T., Hong Kong. 852-26629298

INTERNET: <http://motorola.com/sps>

