

LM4841 Boomer® Audio Power Amplifier Series

Stereo 2W Amplifiers with DC Volume Control, Transient Free Outputs, and Cap-less Headphone Drive

General Description

The LM4841 is a monolithic integrated circuit that provides DC volume control and stereo bridged audio power amplifiers capable of producing 2W into 4Ω (Note 1) or 2.2W into 3Ω (Note 2) with less than 1.0% THD.

The LM4841 uses advanced, latest generation circuitry to eliminate all traces of clicks and pops when the supply voltages is first applied. The amplifier has a headphone-amplifier-select input pin that is used to switch the amplifiers from bridge to single-ended mode for driving headphones. A new circuit topology eliminates headphone output coupling capacitors (patent pending).

Boomer® audio integrated circuits are designed specifically to provide high quality audio while requiring a minimum amount of external components. The LM4841 incorporates a DC volume control, stereo bridged audio power amplifiers and a selectable gain or bass boost, making it optimally suited for multimedia monitors, portable radios, desktop, and portable computer applications.

The LM4841 features an externally controlled, low-power consumption shutdown mode (Shutdown Low), and both a power amplifier and headphone mute for maximum system flexibility and performance.

Note 1: When properly mounted to the circuit board, LM4841MH and LM4841LQ will deliver 2W into 4Ω. The LM4841MT will deliver 1.1W into 8Ω. See the Application Information section for LM4841MH usage information.

Note 2: An LM4841MH that has been properly mounted to the circuit board and forced-air cooled will deliver 2.2W into 3Ω.

Key Specifications

■ P _O at 1% THD+N	
■ into 3Ω (MH and LQ)	2.2W (typ)
■ into 4Ω (MH and LQ)	2.0W (typ)
■ into 8Ω (MT, MH, and LQ)	1.1W (typ)
■ Single-ended THD+N at 85mW into 32Ω	1.0%(typ)
■ Shutdown current	0.7μA (typ)

Features

- Stereo headphone amplifier mode that eliminates the Output Coupling Capacitors (patent pending)
- Acoustically Enhanced DC Volume Control Taper
- System Beep Detect
- Stereo switchable bridged/single-ended power amplifiers
- Selectable internal/external gain and bass boost
- Advanced “click and pop” suppression circuitry
- Thermal shutdown protection circuitry

Applications

- Portable and Desktop Computers
- Multimedia Monitors
- Portable Radios, PDAs, and Portable TVs

Connection Diagrams

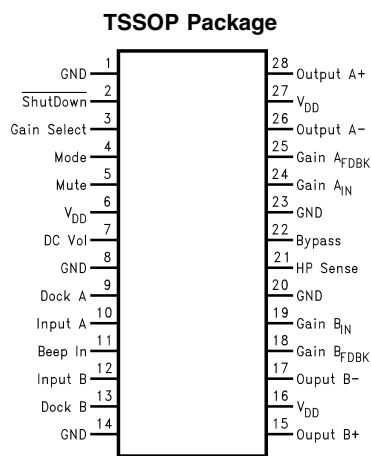

Top View

Order Number LM4841MT or LM4841MH

See NS Package Number MTC28 for TSSOP and MXA28A for Exposed-DAP TSSOP

Boomer® is a registered trademark of National Semiconductor Corporation.

Connection Diagrams (Continued)

LLP Package

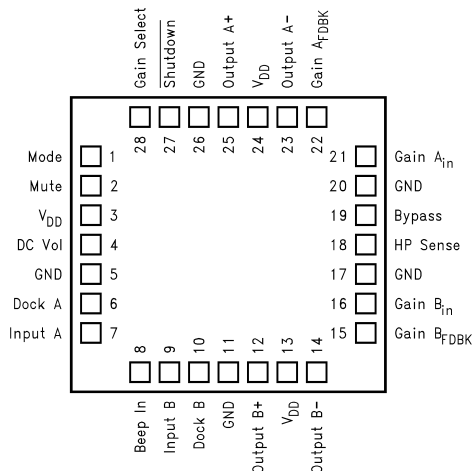

20028097

Top View

Order Number LM4841LQ

See NS Package Number LQA028AA for Exposed-DAP LLP

Block Diagram

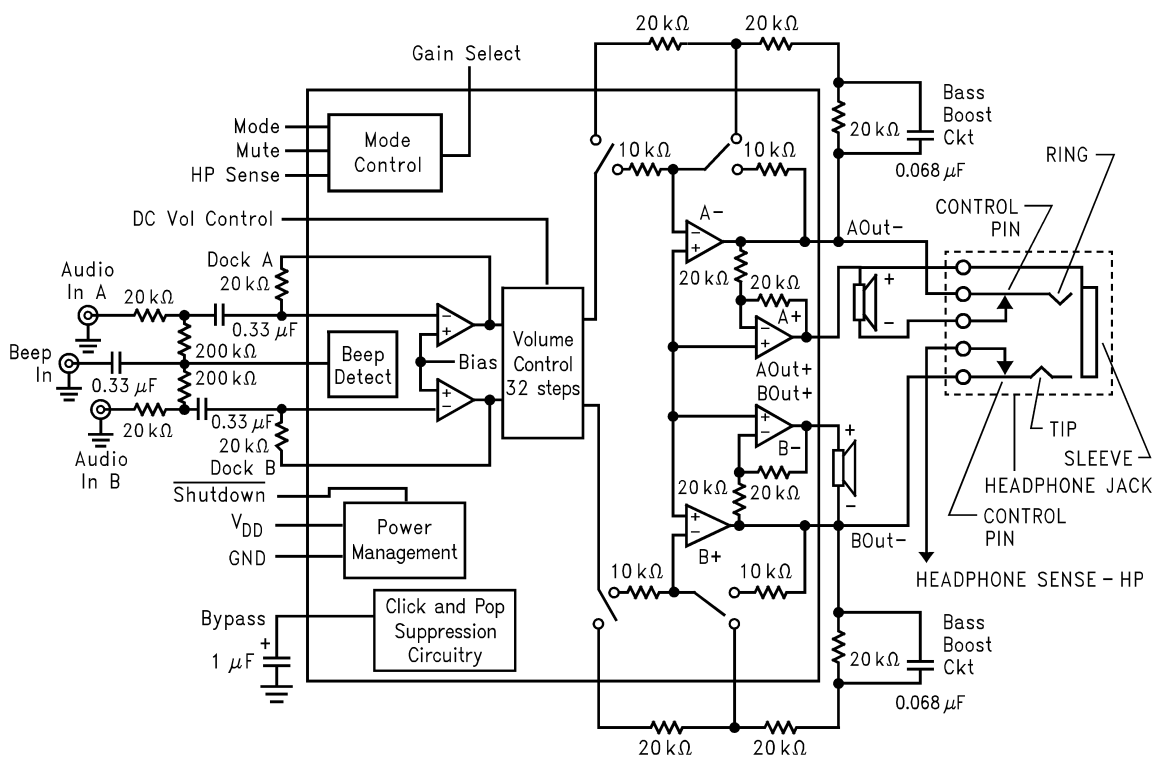

20028001

FIGURE 1. LM4841 Block Diagram

Absolute Maximum Ratings (Note 10)

If Military/Aerospace specified devices are required, please contact the National Semiconductor Sales Office/Distributors for availability and specifications.

Supply Voltage	6.0V
Storage Temperature	-65°C to +150°C
Input Voltage	-0.3V to $V_{DD} + 0.3V$
Power Dissipation (Note 11)	Internally limited
ESD Susceptibility (Note 12)	
All pins except Pin 28	2500V
Pin 28	6500V
ESD Susceptibility (Note 13)	200V
Junction Temperature	150°C
Soldering Information	
Small Outline Package	
Vapor Phase (60 sec.)	215°C
Infrared (15 sec.)	220°C

See AN-450 "Surface Mounting and their Effects on Product Reliability" for other methods of soldering surface mount devices.

θ_{JC} (typ)—LQA028A	3°C/W
θ_{JA} (typ)—LQA028A	42°C/W
θ_{JC} (typ)—MTC28	20°C/W
θ_{JA} (typ)—MTC28	80°C/W
θ_{JC} (typ)—MXA28A	2°C/W
θ_{JA} (typ)—MXA28A (exposed DAP) (Note 4)	41°C/W
θ_{JA} (typ)—MXA28A (exposed DAP) (Note 3)	54°C/W
θ_{JA} (typ)—MXA28A (exposed DAP) (Note 5)	59°C/W
θ_{JA} (typ)—MXA28A (exposed DAP) (Note 6)	93°C/W

Operating Ratings

Temperature Range	$T_{MIN} \leq T_A \leq T_{MAX}$	-40°C ≤ TA ≤ 85°C
Supply Voltage		2.7V ≤ V_{DD} ≤ 5.5V

Electrical Characteristics for Entire IC (Notes 7, 10)

The following specifications apply for $V_{DD} = 5V$ unless otherwise noted. Limits apply for $T_A = 25^\circ C$.

Symbol	Parameter	Conditions	LM4841		Units (Limits)
			Typical (Note 14)	Limit (Note 15)	
V_{DD}	Supply Voltage			2.7	V (min)
				5.5	V (max)
I_{DD}	Quiescent Power Supply Current	$V_{IN} = 0V, I_O = 0A$	15	30	mA (max)
I_{SD}	Shutdown Current	$\overline{V_{shutdown}} = GND$	0.7	2.0	μA (max)
V_{IH}	Headphone Sense High Input Voltage			4	V (min)
V_{IL}	Headphone Sense Low Input Voltage			0.8	V (max)
TH_{um}	Un-Mute Threshold Voltage	Gain 1st Stage = 1		10	mV _{rms}
		$\overline{V_{shutdown}} = V_{DD}$ V_{IN} applied to A or B input	22	40	mV _{rms}

Electrical Characteristics for Volume Attenuators (Notes 7, 10)

The following specifications apply for $V_{DD} = 5V$. Limits apply for $T_A = 25^\circ C$.

Symbol	Parameter	Conditions	LM4841		Units (Limits)
			Typical (Note 14)	Limit (Note 15)	
C_{RANGE}	Attenuator Range	Gain with $V_{DCVol} = 5V$, No Load		±0.75	dB (max)
		Attenuation with $V_{DCVol} = 0V$ (BM & SE)		-75	dB (min)
A_M	Mute Attenuation	$V_{mute} = 5V$, Bridged Mode (BM)		-78	dB (min)
		$V_{mute} = 5V$, Single-Ended Mode (SE)		-78	dB (min)

Electrical Characteristics for Single-Ended Mode Operation (Notes 7, 10)

The following specifications apply for $V_{DD} = 5V$. Limits apply for $T_A = 25^\circ C$.

Symbol	Parameter	Conditions	LM4841		Units (Limits)
			Typical (Note 14)	Limit (Note 15)	
P _O	Output Power	THD = 1.0%; f = 1kHz; R _L = 32Ω	85		mW
		THD = 10%; f = 1 kHz; R _L = 32Ω	95		mW
THD+N	Total Harmonic Distortion+Noise	V _{OUT} = 1V _{RMS} , f=1kHz, R _L = 10kΩ, A _{VD} = 1	0.065		%
PSRR	Power Supply Rejection Ratio	C _B = 1.0 μF, f =120 Hz, V _{RIPPLE} = 200 mVrms	58		dB
SNR	Signal to Noise Ratio	P _{OUT} =75 mW, R _L = 32Ω, A-Wtd Filter	102		dB
X _{talk}	Channel Separation	f=1kHz, C _B = 1.0 μF	65		dB

Electrical Characteristics for Bridged Mode Operation (Notes 7, 10)

The following specifications apply for $V_{DD} = 5V$, unless otherwise noted. Limits apply for $T_A = 25^\circ C$.

Symbol	Parameter	Conditions	LM4841		Units (Limits)
			Typical (Note 14)	Limit (Note 15)	
V _{OS}	Output Offset Voltage	V _{IN} = 0V, No Load	5	±50	mV (max)
P _O	Output Power	THD + N = 1.0%; f=1kHz; R _L = 3Ω (Note 8)	2.2		W
		THD + N = 1.0%; f=1kHz; R _L = 4Ω (Note 9)	2		W
		THD = 1% (max); f = 1 kHz; R _L = 8Ω	1.1	1.0	W (min)
		THD+N = 10%; f = 1 kHz; R _L = 8Ω	1.5		W
THD+N	Total Harmonic Distortion+Noise	P _O = 1W, 20 Hz < f < 20 kHz, R _L = 8Ω, A _{VD} = 2	0.3		%
		P _O = 340 mW, R _L = 32Ω	1.0		%
PSRR	Power Supply Rejection Ratio	C _B = 1.0 μF, f = 120 Hz, V _{RIPPLE} = 200 mVrms; R _L = 8Ω	74		dB
SNR	Signal to Noise Ratio	V _{DD} = 5V, P _{OUT} = 1.1W, R _L = 8Ω, A-Wtd Filter	93		dB
X _{talk}	Channel Separation	f=1kHz, C _B = 1.0 μF	70		dB

Note 3: The θ_{JA} given is for an MXA28A package whose exposed-DAP is soldered to an exposed 2in² piece of 1 ounce printed circuit board copper.

Note 4: The θ_{JA} given is for an MXA28A package whose exposed-DAP is soldered to a 2in² piece of 1 ounce printed circuit board copper on a bottom side layer through 21 8mil vias.

Note 5: The θ_{JA} given is for an MXA28A package whose exposed-DAP is soldered to an exposed 1in² piece of 1 ounce printed circuit board copper.

Note 6: The θ_{JA} given is for an MXA28A package whose exposed-DAP is not soldered to any copper.

Note 7: All voltages are measured with respect to the ground pins, unless otherwise specified. All specifications are tested using the typical application as shown in Figure 1.

Note 8: When driving 3Ω loads from a 5V supply, LM4841MH and LM4841LQ must be mounted to the circuit board and forced-air cooled.

Note 9: When driving 4Ω loads from a 5V supply, the LM4841MH and LM4841LQ must be mounted to the circuit board.

Note 10: *Absolute Maximum Ratings* indicate limits beyond which damage to the device may occur. *Operating Ratings* indicate conditions for which the device is functional, but do not guarantee specific performance limits. *Electrical Characteristics* state DC and AC electrical specifications under particular test conditions which guarantee specific performance limits. This assumes that the device is within the Operating Ratings. Specifications are not guaranteed for parameters where no limit is given, however, the typical value is a good indication of device performance.

Note 11: The maximum power dissipation must be derated at elevated temperatures and is dictated by T_{JMAX} , θ_{JA} , and the ambient temperature T_A . The maximum allowable power dissipation is $P_{DMAX} = (T_{JMAX} - T_A) / \theta_{JA}$. For the LM4841MT and LM4841LQ, $T_{JMAX} = 150^\circ C$. See **Power Dissipation** for further information.

Note 12: Human body model, 100 pF discharged through a 1.5 kΩ resistor.

Note 13: Machine Model, 220 pF–240 pF discharged through all pins.

Note 14: Typicals are measured at 25°C and represent the parametric norm.

Note 15: Limits are guaranteed to National's AOQL (Average Outgoing Quality Level). Datasheet min/max specification limits are guaranteed by design, test, or statistical analysis.

Typical Application

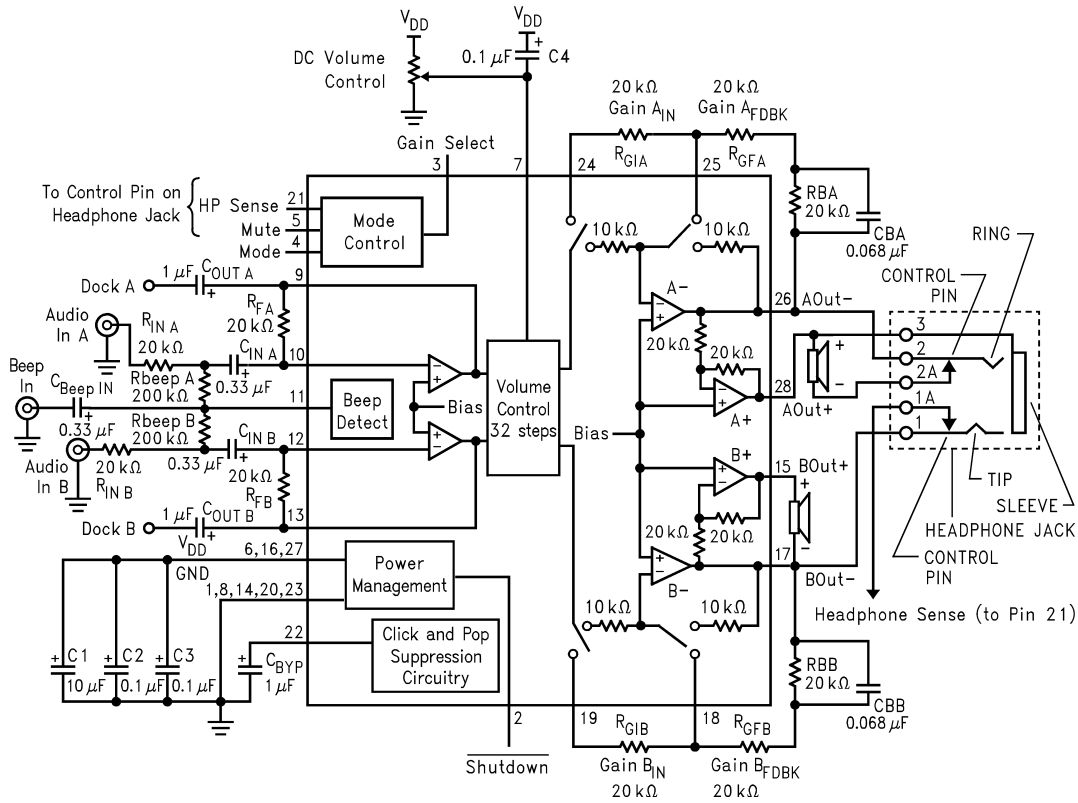

20028003

FIGURE 2. Typical Application Circuit (MT / MH Package Pinout)

Truth Table for Logic Inputs (Note 16)

Headphone Sense	Gain Select	Mode	Mute	Output Stage Set To	Volume Control
X	0	0	0	Internal Gain	On
X	0	0	0	Internal Gain	On
X	1	0	0	External Gain	On
X	1	0	0	External Gain	On
On	0	1	0	Internal Gain	On
Off	0	1	0	External Gain	On
On	1	1	0	External Gain	On
Off	1	1	0	Internal Gain	On
X	X	X	1	X	Muted

Note 16: If system beep is detected on the Beep In pin (pin 11), the system beep will be passed through the bridged amplifier regardless of the logic of the Mute and HP sense pins.

Typical Performance Characteristics MH/LQ Specific Characteristics

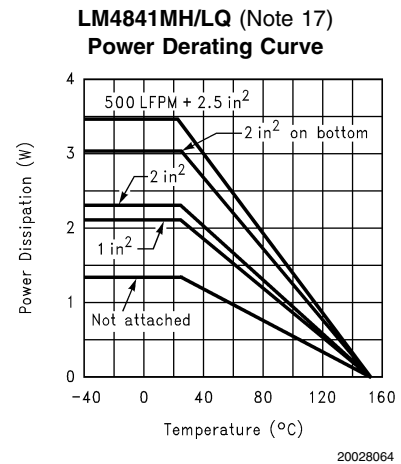
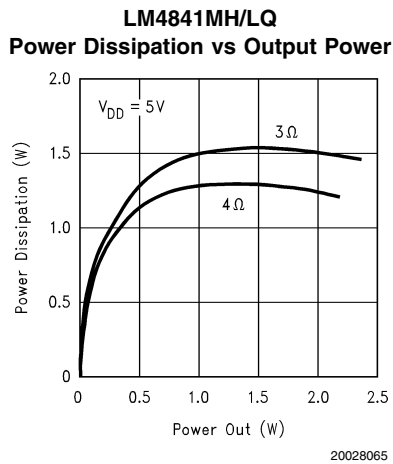
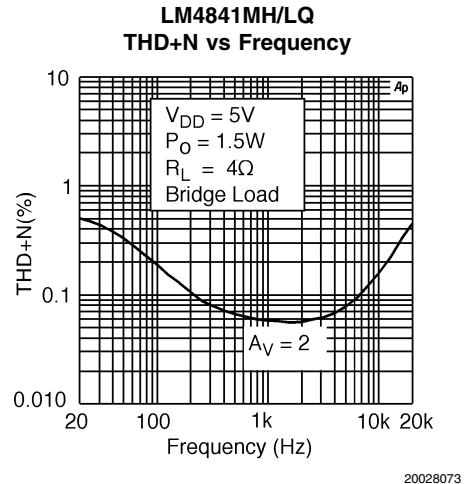
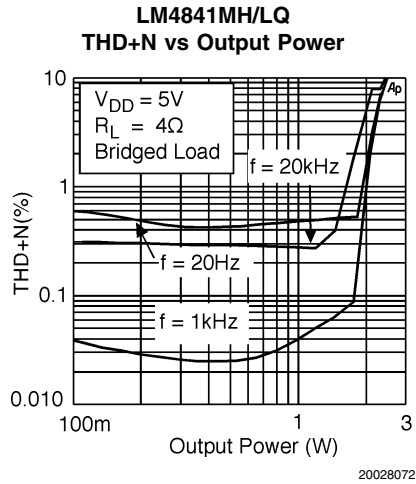
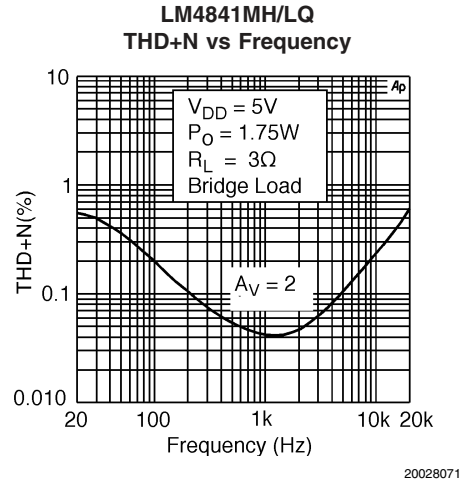
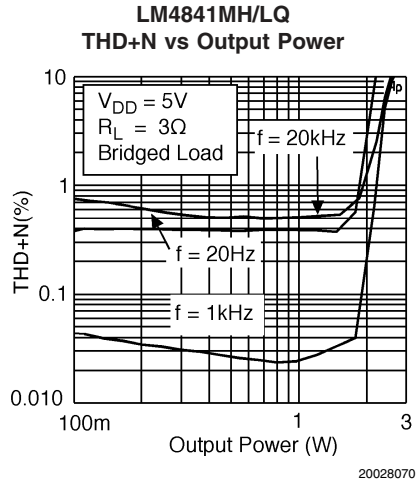

Note 17: These curves show the thermal dissipation ability of the LM4841MH/LQ at different ambient temperatures given these conditions:

500LFPM + 2in²: The part is soldered to a 2in², 1 oz. copper plane with 500 linear feet per minute of forced-air flow across it.

2in²on bottom: The part is soldered to a 2in², 1oz. copper plane that is on the bottom side of the PC board through 21 8 mil vias.

2in²: The part is soldered to a 2in², 1oz. copper plane.

1in²: The part is soldered to a 1in², 1oz. copper plane.

Not Attached: The part is not soldered down and is not forced-air cooled.

Non-MH/LQ Specific Characteristics

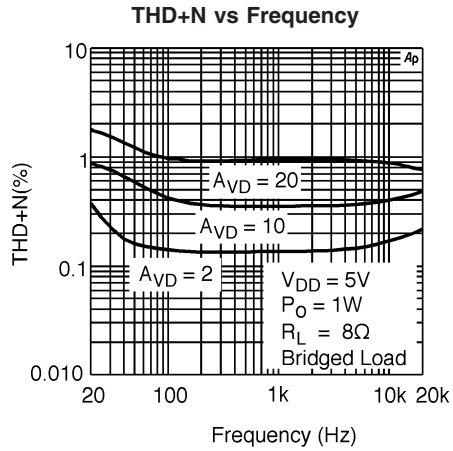

20028057

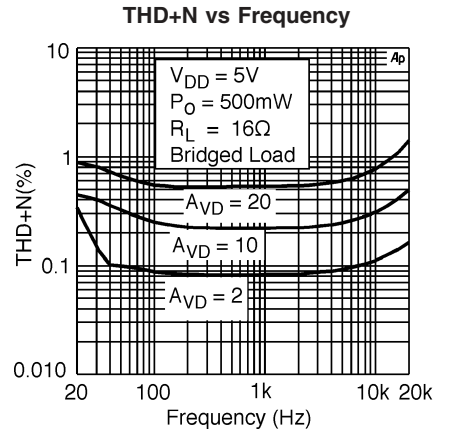

20028058

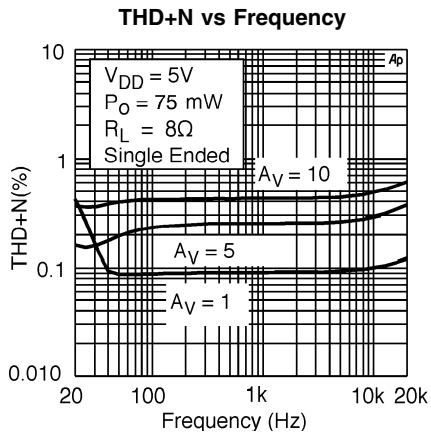

20028014

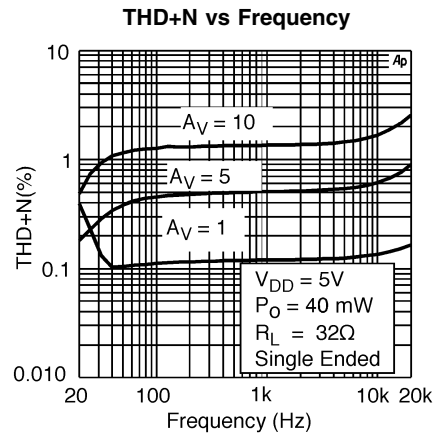

20028015

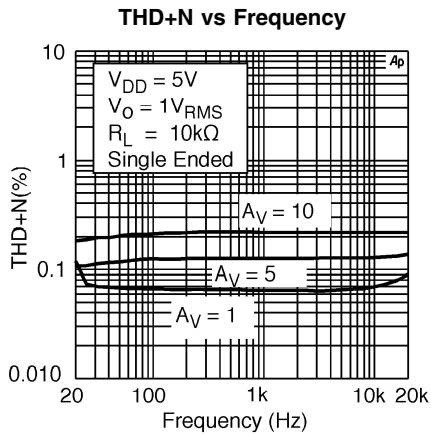

20028016

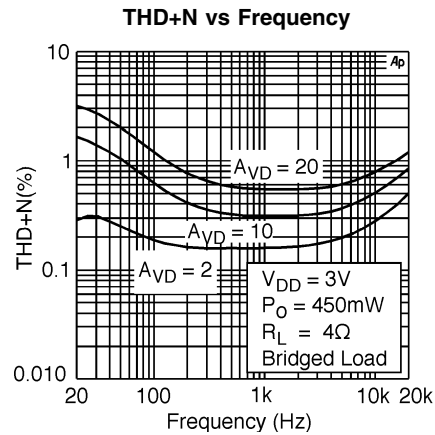

20028017

Non-MH/LQ Specific Characteristics (Continued)

THD+N vs Frequency

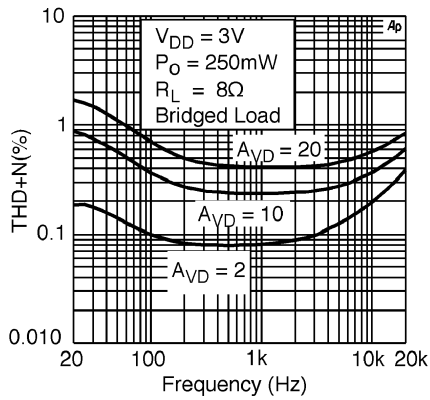

20028018

THD+N vs Frequency

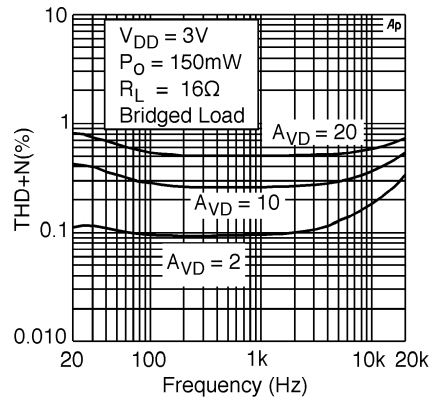

20028019

THD+N vs Frequency

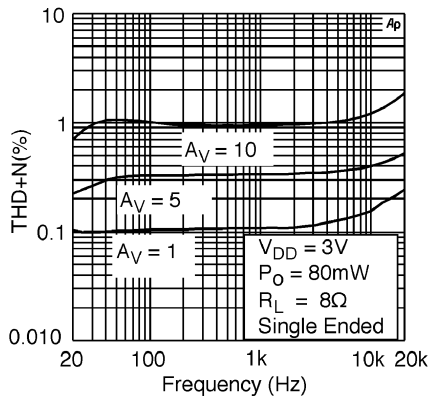

20028020

THD+N vs Frequency

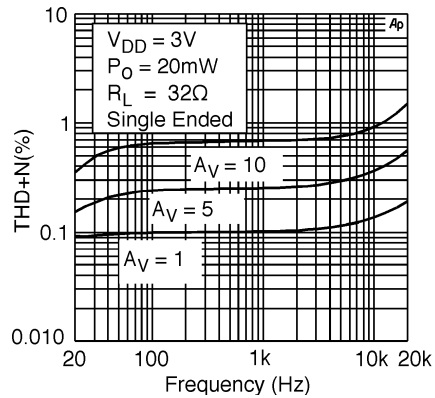

20028021

THD+N vs Frequency

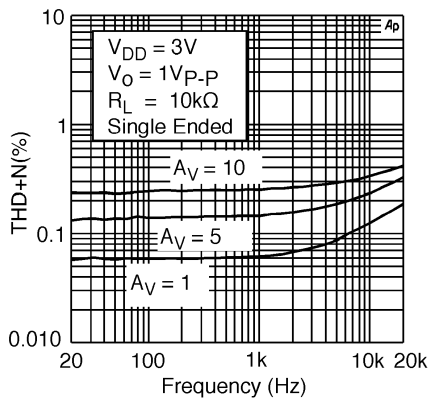

20028022

THD+N vs Output Power

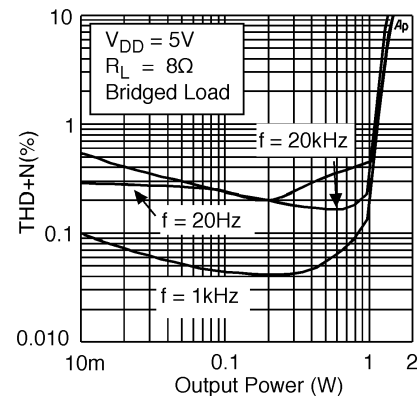

20028024

Non-MH/LQ Specific Characteristics (Continued)

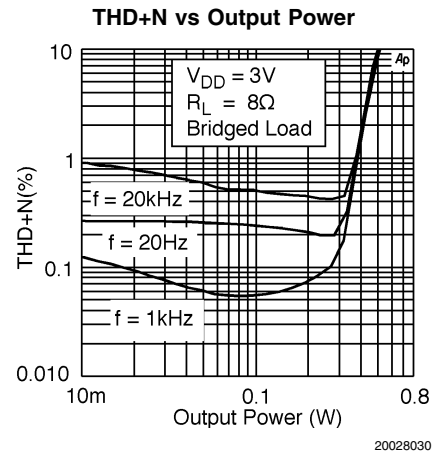
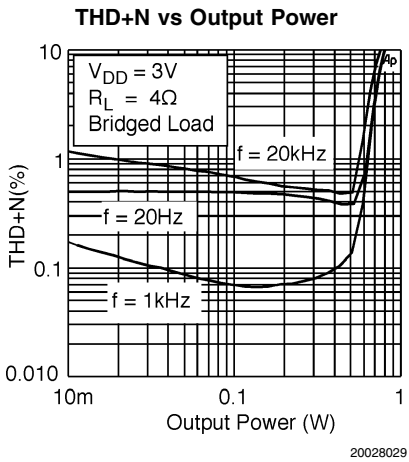
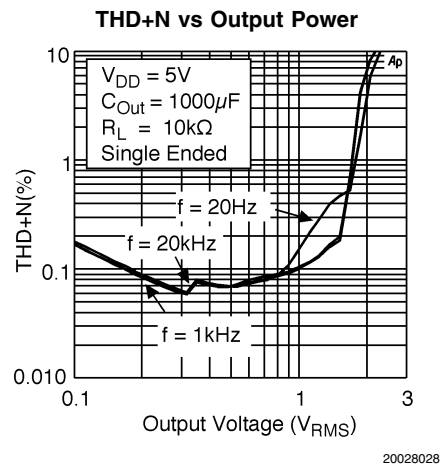
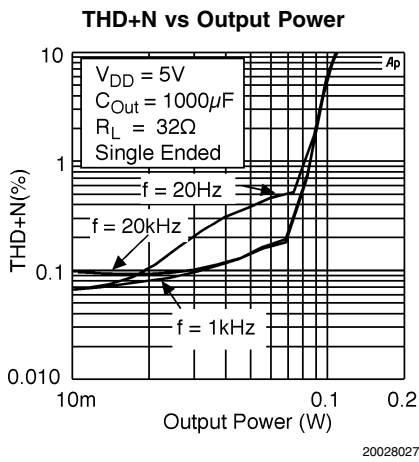
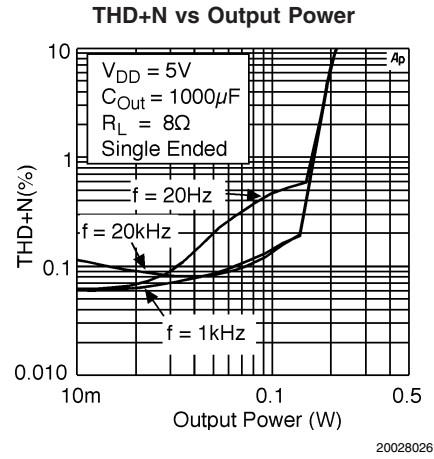
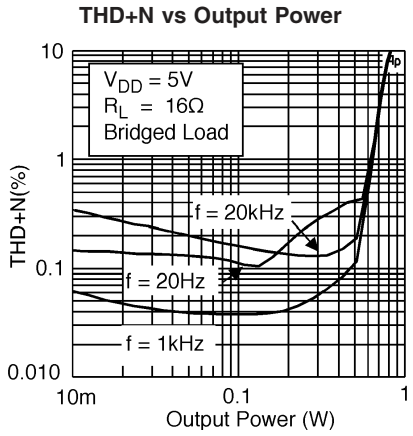

Non-MH/LQ Specific Characteristics (Continued)

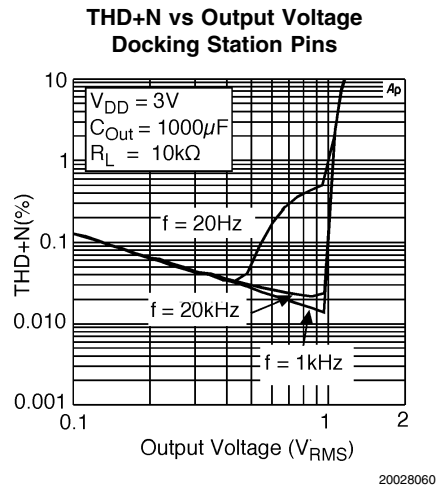
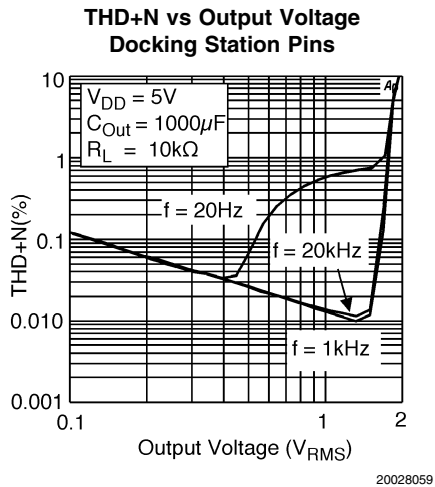
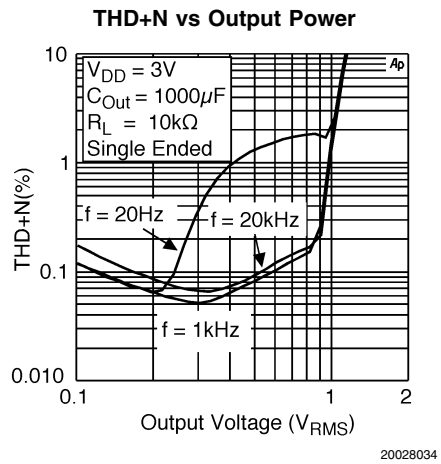
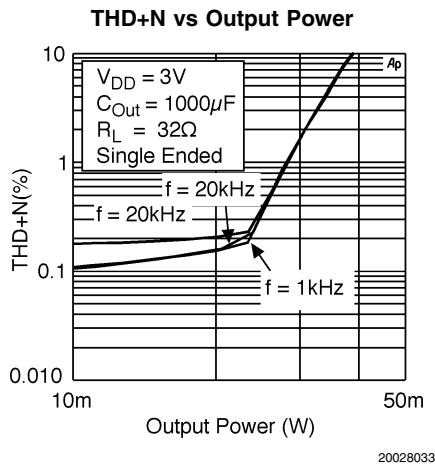
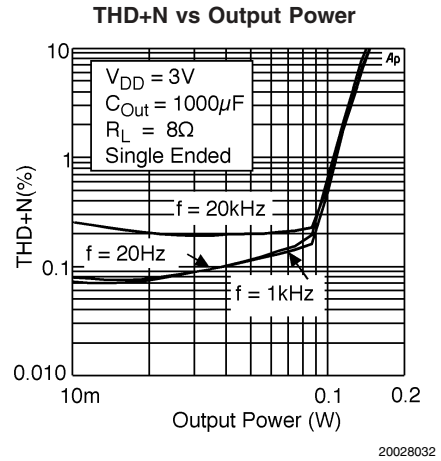
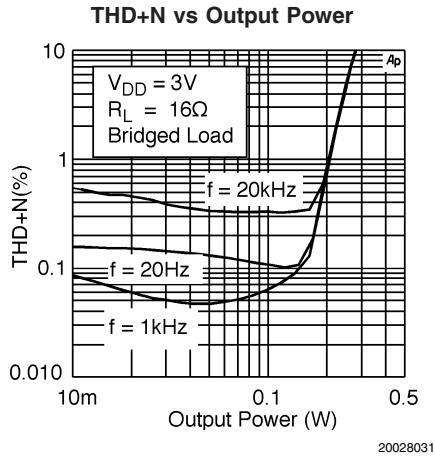

Typical Performance Characteristics

Output Power vs Load Resistance

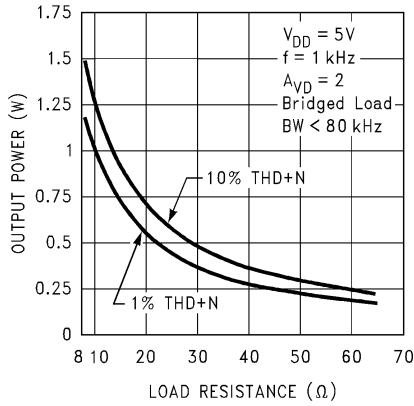

20028062

Output Power vs Load Resistance

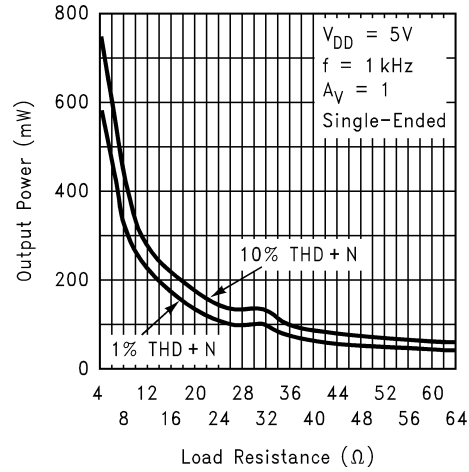

20028006

Output Power vs Load Resistance

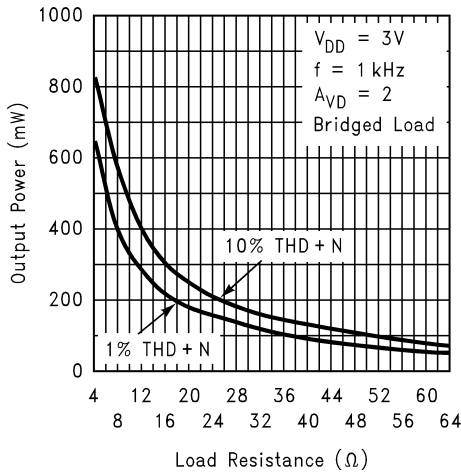

20028007

Power Supply Rejection Ratio

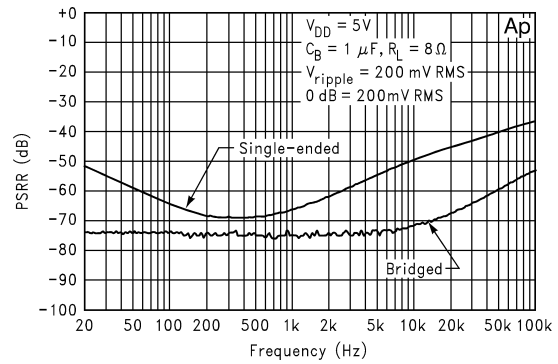

20028039

Dropout Voltage

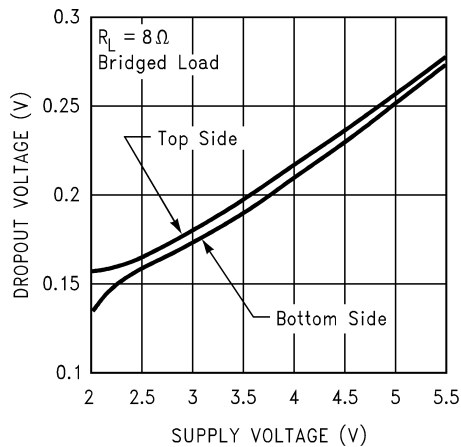

20028053

Output Power vs Load Resistance

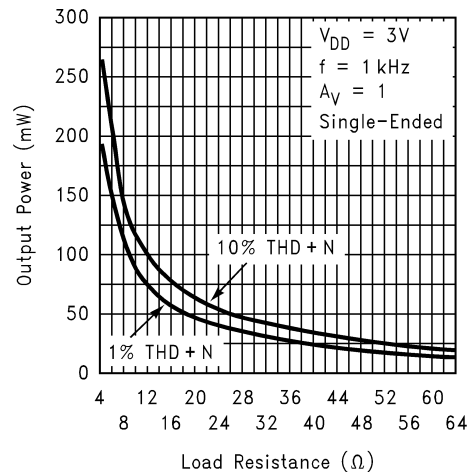

20028008

Typical Performance Characteristics (Continued)

Volume Control Characteristics

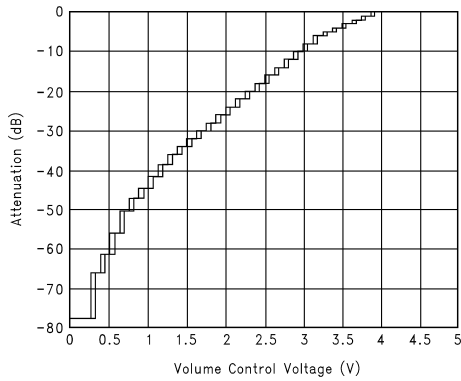

20028040

Power Dissipation vs Output Power

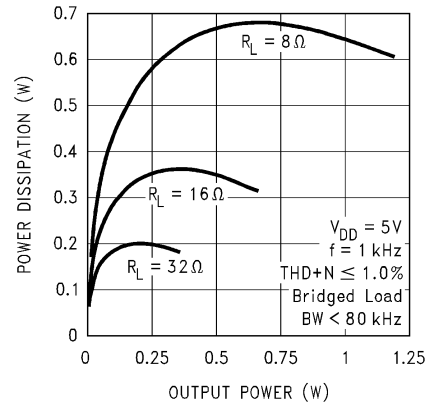

20028051

Power Dissipation vs Output Power

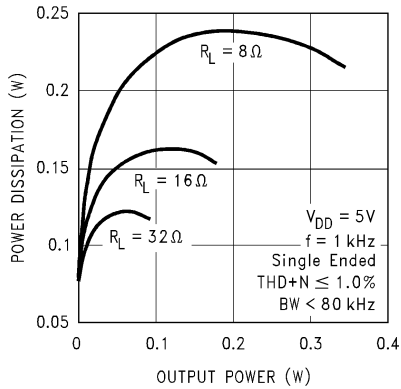

20028052

External Gain/ Bass Boost Characteristics

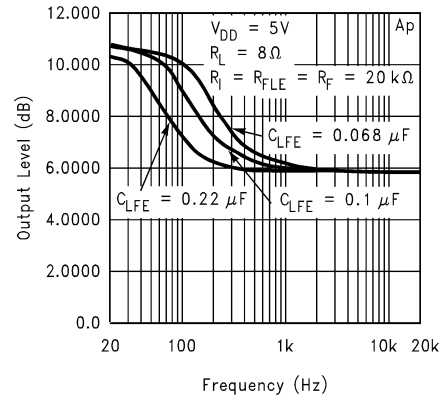

20028061

Power Derating Curve

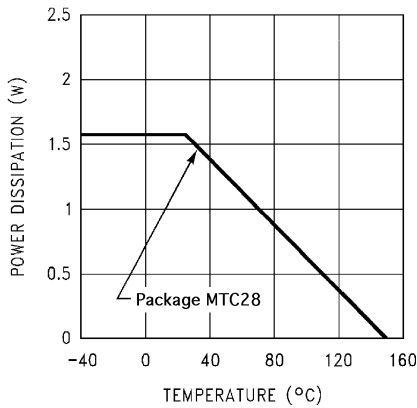

20028063

Crosstalk

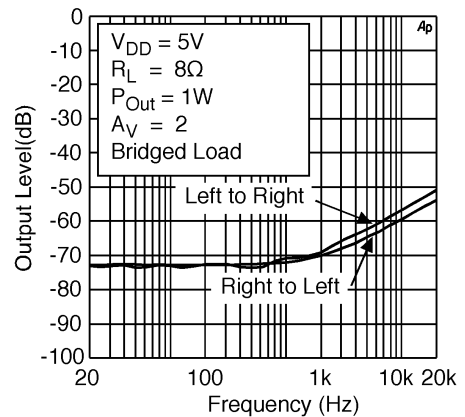

20028049

Typical Performance Characteristics (Continued)

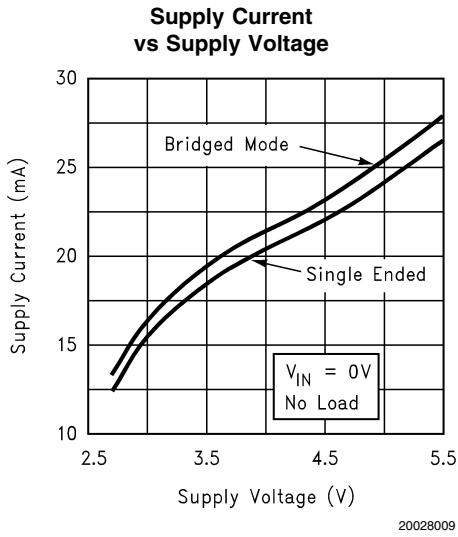
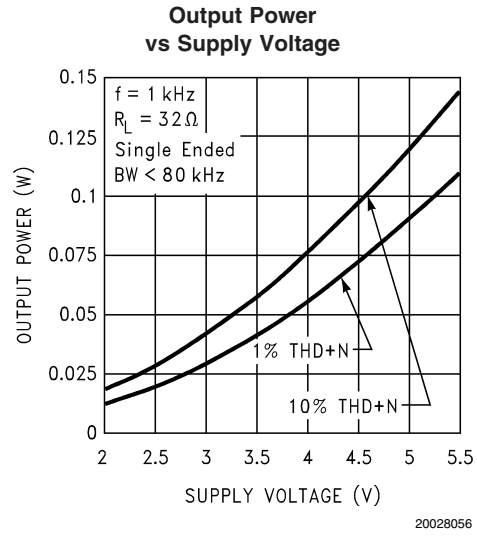
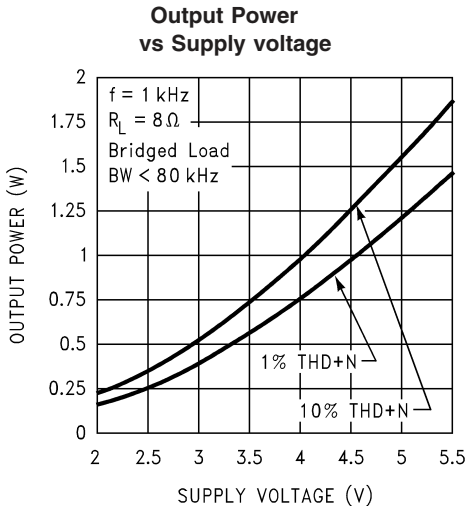

Application Information

ELIMINATING OUTPUT COUPLING CAPACITORS

Typical single-supply audio amplifiers that can switch between driving bridge-tied-load (BTL) speakers and single-ended (SE) headphones use a coupling capacitor on each SE output. This capacitor blocks the half-supply voltage to which the output amplifiers are typically biased and couples the audio signal to the headphones. The signal return to circuit ground is through the headphone jack's sleeve.

The LM4841 eliminates these coupling capacitors. AmplifierA+ (pin 28 on MT/MH) is internally configured to apply $V_{DD}/2$ to a stereo headphone jack's sleeve. This voltage matches the quiescent voltage present on the AmpAout- and AmpBout- outputs that drive the headphones. The headphones operate in a manner very similar to a bridge-tied-load (BTL). The same DC voltage is applied to both headphone speaker terminals. This results in no net DC current flow through the speaker. AC current flows through a headphone speaker as an audio signal's output amplitude increases on the speaker's terminal.

When operating as a headphone amplifier, the headphone jack sleeve is not connected to circuit ground. Using the headphone output jack as a line-level output will place the

LM4841's one-half supply voltage on a plug's sleeve connection. Driving a portable notebook computer or audio-visual display equipment is possible. This presents no difficulty when the external equipment uses capacitively coupled inputs. For the very small minority of equipment that is DC-coupled, the LM4841 monitors the current supplied by the amplifier that drives the headphone jack's sleeve. If this current exceeds 500mA_{PK} , the amplifier is shutdown, protecting the LM4841 and the external equipment.

OUTPUT TRANSIENT ('POPS AND CLICKS') ELIMINATED

The LM4841 contains advanced circuitry that eliminates output transients ('pop and click'). This circuitry prevents all traces of transients when the supply voltage is first applied, when the part resumes operation after shutdown, or when switching between BTL speakers and SE headphones. Two circuits combine to eliminate pop and click. One circuit mutes the output when switching between speaker loads. Another circuit monitors the input signal. It maintains the muted condition until there is sufficient input signal magnitude ($>22\text{mV}_{RMS}$, typ) to mask any remaining transient that may occur. (See Turn On Characteristics).

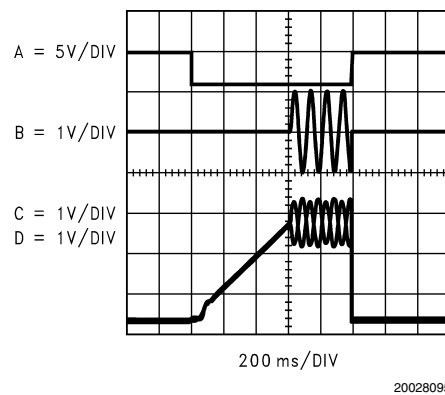

FIGURE 3. Differential output signal (Trace B) is devoid of transients. The SHUTDOWN pin is driven by a shutdown signal (Trace A). The inverting output (Trace C) and the non-inverting output (Trace D) are applied across an 8Ω BTL load.

Figure 3 shows the LM4841's lack of transients in the differential signal (Trace B) across a BTL 8Ω load. The LM4841's active-high SHUTDOWN pin is driven by the logic signal shown in Trace A. Trace C is the VOUT- output signal and trace D is the VOUT+ output signal. The shutdown signal

frequency is 1Hz with a 50% duty cycle. Figure 4 is generated with the same conditions except that the output drives a 32Ω single-ended (SE) load. Again, no trace of output transients on Trace B can be observed.

Application Information (Continued)

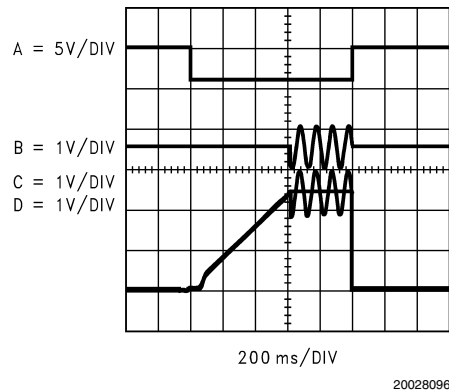

FIGURE 4. Single-ended output signal (Trace B) is devoid of transients. The SHUTDOWN pin is driven by a shutdown signal (Trace A). The inverting output (Trace C) and the V_{BYPASS} output (Trace D) are applied across a 32Ω BTL load.

EXPOSED-DAP PACKAGE PCB MOUNTING CONSIDERATIONS

The LM4841's exposed-DAP (die attach paddle) packages (MH,LQ) provide a low thermal resistance between the die and the PCB to which the part is mounted and soldered. This allows rapid heat transfer from the die to the surrounding PCB copper traces, ground plane and, finally, surrounding air. The result is a low voltage audio power amplifier that produces 2.1W at $\leq 1\%$ THD with a 4Ω load. This high power is achieved through careful consideration of necessary thermal design. Failing to optimize thermal design may compromise the LM4841's high power performance and activate unwanted, though necessary, thermal shutdown protection.

The MH and LQ packages must have their exposed DAPs soldered to a grounded copper pad on the PCB. The DAP's PCB copper pad is connected to a large grounded plane of continuous unbroken copper. This plane forms a thermal mass heat sink and radiation area. Place the heat sink area on either outside plane in the case of a two-sided PCB, or on an inner layer of a board with more than two layers. Connect the DAP copper pad to the inner layer or backside copper heat sink area with $32(4 \times 8)$ (MH) vias or $6(3 \times 2)$ LQ. The via diameter should be $0.012\text{in} - 0.013\text{in}$ with a 1.27mm pitch. Ensure efficient thermal conductivity by plating-through and solder-filling the vias.

Best thermal performance is achieved with the largest practical copper heat sink area. If the heatsink and amplifier share the same PCB layer, a nominal 2.5in^2 (min) area is necessary for 5V operation with a 4Ω load. Heatsink areas not placed on the same PCB layer as the LM4841MH and LQ packages should be 5in^2 (min) for the same supply voltage and load resistance. The last two area recommendations apply for 25°C ambient temperature. Increase the area to compensate for ambient temperatures above 25°C . The junction temperature must be held below 150°C to prevent activating the LM4841's thermal shutdown protection. The LM4841's power de-rating curve in the **Typical Performance Characteristics** shows the maximum power dissipation versus temperature. Example PCB layouts for the exposed-DAP TSSOP and LQ packages are shown in the **Demonstration Board Layout** section. Further detailed and specific information concerning PCB layout and fabrication is available in National Semiconductor's AN1187.

PCB LAYOUT AND SUPPLY REGULATION CONSIDERATIONS FOR DRIVING 3Ω AND 4Ω LOADS

Power dissipated by a load is a function of the voltage swing across the load and the load's impedance. As load impedance decreases, load dissipation becomes increasingly dependent on the interconnect (PCB trace and wire) resistance between the amplifier output pins and the load's connections. Residual trace resistance causes a voltage drop, which results in power dissipated in the trace and not in the load as desired. For example, 0.1Ω trace resistance reduces the output power dissipated by a 4Ω load from 2.1W to 2.0W. This problem of decreased load dissipation is exacerbated as load impedance decreases. Therefore, to maintain the highest load dissipation and widest output voltage swing, PCB traces that connect the output pins to a load must be as wide as possible.

Poor power supply regulation adversely affects maximum output power. A poorly regulated supply's output voltage decreases with increasing load current. Reduced supply voltage causes decreased headroom, output signal clipping, and reduced output power. Even with tightly regulated supplies, trace resistance creates the same effects as poor supply regulation. Therefore, making the power supply traces as wide as possible helps maintain full output voltage swing.

BRIDGE CONFIGURATION EXPLANATION

As shown in *Figure 2*, the LM4841 output stage consists of two pairs of operational amplifiers, forming a two-channel (channel A and channel B) stereo amplifier. (Though the following discusses channel A, it applies equally to channel B.)

Figure 2 shows that the first amplifier's negative (-) output serves as the second amplifier's input. This results in both amplifiers producing signals identical in magnitude, but 180° out of phase. Taking advantage of this phase difference, a load is placed between $-OUTA$ and $+OUTA$ and driven differentially (commonly referred to as "bridge mode"). This results in a differential gain of

$$A_{VD} = 2 * (R_{GFA}/R_{GIA}) \quad (1)$$

Application Information (Continued)

Bridge mode amplifiers are different from single-ended amplifiers that drive loads connected between a single amplifier's output and ground. For a given supply voltage, bridge mode has a distinct advantage over the single-ended configuration: **its differential output doubles the voltage swing across the load.** This produces four times the output power when compared to a single-ended amplifier under the same conditions. This increase in attainable output power assumes that the amplifier is not current limited or that the output signal is not clipped. To ensure minimum output signal clipping when choosing an amplifier's closed-loop gain, refer to the **Audio Power Amplifier Design** section.

Another advantage of the differential bridge output is no net DC voltage across the load. This is accomplished by biasing channel A's and channel B's outputs at half-supply. This eliminates the coupling capacitor that single supply, single-ended amplifiers require. Eliminating an output coupling capacitor in a single-ended configuration forces a single-supply amplifier's half-supply bias voltage across the load. This increases internal IC power dissipation and may permanently damage loads such as speakers.

POWER DISSIPATION

Power dissipation is a major concern when designing a successful single-ended or bridged amplifier. Equation (2) states the maximum power dissipation point for a single-ended amplifier operating at a given supply voltage and driving a specified output load.

$$P_{\text{DMAX}} = (V_{\text{DD}})^2 / (2\pi^2 R_L) \quad \text{Single-Ended} \quad (2)$$

However, a direct consequence of the increased power delivered to the load by a bridge amplifier is higher internal power dissipation for the same conditions.

The LM4841 has two operational amplifiers per channel. The maximum internal power dissipation per channel operating in the bridge mode is four times that of a single-ended amplifier. From Equation (3), assuming a 5V power supply and a 4Ω load, the maximum single channel power dissipation is 1.27W or 2.54W for stereo operation.

$$P_{\text{DMAX}} = 4 * (V_{\text{DD}})^2 / (2\pi^2 R_L) \quad \text{Bridge Mode} \quad (3)$$

The LM4841's power dissipation is twice that given by Equation (2) or Equation (3) when operating in the single-ended mode or bridge mode, respectively. Twice the maximum power dissipation point given by Equation (3) must not exceed the power dissipation given by Equation (4):

$$P_{\text{DMAX}}' = (T_{\text{JMAX}} - T_A) / \theta_{\text{JA}} \quad (4)$$

The LM4841's $T_{\text{JMAX}} = 150^\circ\text{C}$. In the LQ package soldered to a DAP pad that expands to a copper area of 5in^2 on a PCB, the LM4841's θ_{JA} is 20°C/W . In the MH and LQ packages soldered to a DAP pad that expands to a copper area of 2in^2 on a PCB, the LM4841MH's and LQ's θ_{JA} is 41°C/W . For the LM4841MT package, $\theta_{\text{JA}} = 80^\circ\text{C/W}$. At any given ambient temperature T_A , use Equation (4) to find the maximum internal power dissipation supported by the IC packaging. Rearranging Equation (4) and substituting P_{DMAX} for P_{DMAX}' results in Equation (5). This equation gives the maxi-

imum ambient temperature that still allows maximum stereo power dissipation without violating the LM4841's maximum junction temperature.

$$T_A = T_{\text{JMAX}} - 2 * P_{\text{DMAX}} \theta_{\text{JA}} \quad (5)$$

For a typical application with a 5V power supply and an 4Ω load, the maximum ambient temperature that allows maximum stereo power dissipation without exceeding the maximum junction temperature is approximately 45°C for the MH package.

$$T_{\text{JMAX}} = P_{\text{DMAX}} \theta_{\text{JA}} + T_A \quad (6)$$

Equation (6) gives the maximum junction temperature T_{JMAX} . If the result violates the LM4841's 150°C T_{JMAX} , reduce the maximum junction temperature by reducing the power supply voltage or increasing the load resistance. Further allowance should be made for increased ambient temperatures.

The above examples assume that a device is a surface mount part operating around the maximum power dissipation point. Since internal power dissipation is a function of output power, higher ambient temperatures are allowed as output power or duty cycle decreases.

If the result of Equation (2) is greater than that of Equation (3), then decrease the supply voltage, increase the load impedance, or reduce the ambient temperature. If these measures are insufficient, a heat sink can be added to reduce θ_{JA} . The heat sink can be created using additional copper area around the package, with connections to the ground pin(s), supply pin and amplifier output pins. External, solder attached SMT heatsinks such as the Thermalloy 7106D can also improve power dissipation. When adding a heat sink, the θ_{JA} is the sum of θ_{JC} , θ_{CS} , and θ_{SA} . (θ_{JC} is the junction-to-case thermal impedance, θ_{CS} is the case-to-sink thermal impedance, and θ_{SA} is the sink-to-ambient thermal impedance.) Refer to the **Typical Performance Characteristics** curves for power dissipation information at lower output power levels.

POWER SUPPLY BYPASSING

As with any power amplifier, proper supply bypassing is critical for low noise performance and high power supply rejection. Applications that employ a 5V regulator typically use a 10 μF in parallel with a 0.1 μF filter capacitor to stabilize the regulator's output, reduce noise on the supply line, and improve the supply's transient response. However, their presence does not eliminate the need for a local 1.0 μF tantalum bypass capacitance connected between the LM4841's supply pins and ground. Do not substitute a ceramic capacitor for the tantalum. Doing so may cause oscillation. Keep the length of leads and traces that connect capacitors between the LM4841's power supply pin and ground as short as possible. Connecting a 1μF capacitor, C_B , between the BYPASS pin and ground improves the internal bias voltage's stability and the amplifier's PSRR. The PSRR improvements increase as the bypass pin capacitor value increases. Too large a capacitor, however, increases turn-on time and can compromise the amplifier's click and pop performance. The selection of bypass capacitor values, especially C_B , depends on desired PSRR requirements, click and pop performance (as explained in the following section, **Selecting Proper External Components**), system cost, and size constraints.

Application Information (Continued)

SELECTING PROPER EXTERNAL COMPONENTS

Optimizing the LM4841's performance requires properly selecting external components. Though the LM4841 operates well when using external components with wide tolerances, best performance is achieved by optimizing component values.

The LM4841 is unity-gain stable, giving a designer maximum design flexibility. The gain should be set to no more than a given application requires. This allows the amplifier to achieve minimum THD+N and maximum signal-to-noise ratio. These parameters are compromised as the closed-loop gain increases. However, low gain circuits demand input signals with greater voltage swings to achieve maximum output power. Fortunately, many signal sources such as audio CODECs have outputs of $1V_{RMS}$ ($2.83V_{P-P}$). Please refer to the **Audio Power Amplifier Design** section for more information on selecting the proper gain.

Input Capacitor Value Selection

Amplifying the lowest audio frequencies requires a high value input coupling capacitor ($0.33\mu F$ in *Figure 2*), but high value capacitors can be expensive and may compromise space efficiency in portable designs. In many cases, however, the speakers used in portable systems, whether internal or external, have little ability to reproduce signals below 150 Hz. Applications using speakers with this limited frequency response reap little improvement by using a large input capacitor.

Besides effecting system cost and size, the input coupling capacitor has an affect on the LM4841's click and pop performance. When the supply voltage is first applied, a transient (pop) is created as the charge on the input capacitor changes from zero to a quiescent state. The magnitude of the pop is directly proportional to the input capacitor's size. Higher value capacitors need more time to reach a quiescent DC voltage (usually $V_{DD}/2$) when charged with a fixed current. The amplifier's output charges the input capacitor through the feedback resistor, R_f . Thus, pops can be minimized by selecting an input capacitor value that is no higher than necessary to meet the desired $-6dB$ frequency.

As shown in *Figure 2*, the input resistor (R_{IA} , $R_{IB} = 20k$) (and the input capacitor (C_{IA} , $C_{IB} = 0.33\mu F$) produce a $-6dB$ high pass filter cutoff frequency that is found using Equation (7).

$$f_{-6dB} = \frac{1}{2\pi R_{IN} C_{IN}} \quad (7)$$

As an example when using a speaker with a low frequency limit of 150Hz, the input coupling capacitor, using Equation (7), is $0.063\mu F$. The $0.33\mu F$ input coupling capacitor shown in *Figure 2* allows the LM4841 to drive a high efficiency, full range speaker whose response extends below 30Hz.

TURN ON Characteristics

The LM4841 contains advanced circuitry that minimizes turn-on and shutdown transients or "clicks and pops". For this discussion, turn-on refers to either applying the power supply voltage or when the shutdown mode is deactivated. While the power supply is ramping to its final value, the LM4841's internal amplifiers are configured as unity gain buffers. An internal current source changes the voltage of

the BYPASS pin in a controlled, linear manner. Ideally, the input and outputs track the voltage applied to the BYPASS pin. The gain of the internal amplifiers remains unity until the voltage on the BYPASS pin reaches $1/2 V_{DD}$. As soon as the voltage on the BYPASS pin is stable, the LM4841 is ready to be fully turned on. To turn the device on, the input signal must exceed $22mV_{rms}$. This is accomplished through a threshold detect circuit that enables all appropriate output amplifiers after the $22mV_{rms}$ limit is reached. Until this threshold is reached, some of the amplifiers remain in a tri-state mode. This insures that there is no current flowing through to the speakers or headphones during power up. Without current flow, the speakers or headphones remain silent. During headphone mode, A+, B-, and B+ are in tri-state mode during power up. During speaker mode, A+ and B+ are in tri-state mode during power up.

Although the BYPASS pin current cannot be modified, changing the size of C_{BYP} alters the device's turn-on time. As the size of C_{BYP} increases, the turn-on time increases. There is a linear relationship between the size of C_{BYP} and the turn-on time. Here are some typical turn-on times for various values of C_{BYP} :

C_{BYP}	T_{ON}
$0.01\mu F$	2ms
$0.1\mu F$	20ms
$0.22\mu F$	44ms
$0.47\mu F$	94ms
$1.0\mu F$	200ms

DOCKING STATION INTERFACE

Applications such as notebook computers can take advantage of a docking station to connect to external devices such as monitors or audio/visual equipment that sends or receives line level signals. The LM4841 has two outputs, Dock A and Dock B, which connect to outputs of the internal input amplifiers that drive the volume control inputs. These input amplifiers can drive loads of $>1k\Omega$ (such as powered speakers) with a rail-to-rail signal. Since the output signal present on the Dock A and Dock B pins are biased to $V_{DD}/2$, coupling capacitors should be connected in series with the load when using these outputs. Typical values for the output coupling capacitors are $0.33\mu F$ to $1.0\mu F$. If polarized coupling capacitors are used, connect their '+' terminals to the respective output pin.

Since the Dock outputs precede the internal volume control, the signal amplitude will be equal to the input signal's magnitude and cannot be adjusted. However, the input amplifier's closed-loop gain can be adjusted using external resistors. These $20k$ resistors (R_{FA} and R_{FB}) are shown in *Figure 2* and they set each input amplifier's gain to -1 . Use Equation 7 to determine the input and feedback resistor values for a desired gain.

$$-A_v = R_F / R_{IN} \quad (8)$$

Adjusting the input amplifier's gain sets the minimum gain for that channel. Although the single ended output of the Bridge Output Amplifiers can be used to drive line level outputs, it is recommended that the A & B Dock Outputs simpler signal path be used for better performance.

Application Information (Continued)

BEEP DETECT FUNCTION

Computers and notebooks produce a system “beep” signal that drives a small speaker. The speaker’s auditory output signifies that the system requires user attention or input. To accommodate this system alert signal, the LM4841’s beep input pin is a mono input that accepts the beep signal. Internal level detection circuitry at this input monitors the beep signal’s magnitude. When a signal level greater than $V_{DD}/2$ is detected on the BEEP IN pin, the bridge output amplifiers are enabled. The beep signal is amplified and applied to the load connected to the output amplifiers. A valid beep signal will be applied to the load even when MUTE is active. Use the input resistors connected between the BEEP IN pin and the stereo input pins to accommodate different beep signal amplitudes. These resistors are shown as 200k Ω devices in *Figure 2*. Use higher value resistors to reduce the gain applied to the beep signal. The resistors must be used to pass the beep signal to the stereo inputs. The BEEP IN pin is used only to detect the beep signal’s magnitude: it does not pass the signal to the output amplifiers. The LM4841’s shutdown mode must be deactivated before a system alert signal is applied to BEEP IN pin.

MICRO-POWER SHUTDOWN

The voltage applied to the SHUTDOWN pin controls the LM4841’s shutdown function. Activate micro-power shutdown by applying ground (logic low) to the SHUTDOWN pin.

When activated, the LM4841’s micro-power shutdown feature turns off the amplifier’s bias circuitry, reducing the supply current. On the demo board, the micro-power shutdown feature is controlled by a single pole switch that connects the shutdown pin to either V_{DD} , for normal operation, or directly to ground to enable shutdown. In a system with a microprocessor or a microcontroller, use a digital output to apply the control voltage to the SHUTDOWN pin.

MODE FUNCTION

The LM4841’s MODE function has 2 states controlled by the voltage applied to the MODE pin. In Mode 0 (mode pin at GND), the HP Sense has no effect on the gain setting (only the Gain Select Input Controls either internal or external gain). In Mode 1 (mode pin tied high), the HP Sense and Gain Select both can toggle between Internal and External Gain. See ‘Truth Table for Logic Inputs’ on page 5.

MUTE FUNCTION

The LM4841 mutes the amplifier and DOCK outputs when V_{DD} is applied to the MUTE pin. Even while muted, the LM4841 will amplify a system alert (beep) signal whose magnitude satisfies the BEEP DETECT circuitry. Applying 0V to the MUTE pin returns the LM4841 to normal, unmuted operation. Prevent unanticipated mute behavior by connecting the MUTE pin to V_{DD} or ground. Do not let the mute pin float.

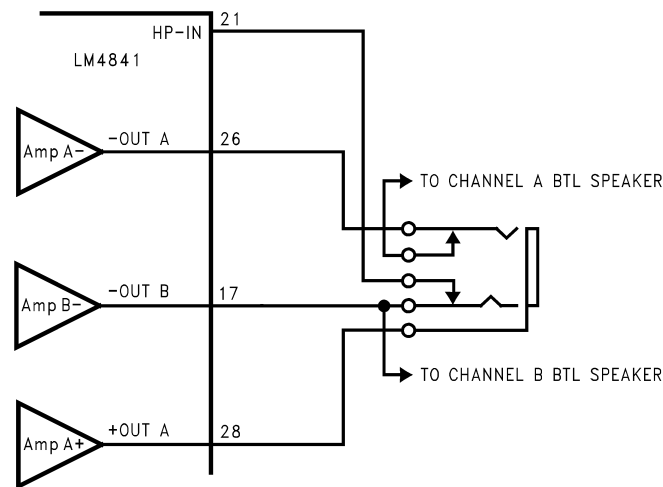

20028087

FIGURE 5. Headphone Sensing Circuit (MT & MH Packages)

Application Information (Continued)

CAP-LESS HEADPHONE (SINGLE-ENDED) AMPLIFIER OPERATION

An internal pull-up circuit is connected to the HP Sense (Pin 21 HP-IN) headphone amplifier control pin. When this pin is left unconnected, V_{DD} is applied to the HP-IN. This turns off Amp B +OUT (not seen in Fig 5, see Fig 2 Pin 15) and switches Amp A +OUT's input signal from an audio signal to the $V_{DD}/2$ voltage present on pin 28 (Amp A + OUT). The result is muted bridge-connected loads. Quiescent current consumption is reduced when the IC is in this single-ended mode.

Figure 5 above shows the implementation of the LM4841's headphone control function. An internal comparator with a nominal 400mV offset monitors the signal present at the -OUT B output. It compares this signal against the signal applied to the HP-IN pin (Notice in Figure 5, Pin 21 is shorted to Pin 17 without a headphone plugged in). When these signals are equal, as in the case when a BTL is connected to the amplifier, an internal comparator forces the LM4841 to maintain bridged-amplifier operation. When the HP-IN pin is externally floated, such as when headphones are connected to the jack shown in Figure 5, an internal pull-up forces V_{DD} on the internal comparator's HP-IN inputs. This changes the comparator's output state and enables the headphone function: it turns off Amp B +OUT (not seen in Fig 5, see Fig 2 Pin 15), switches the Amp A +OUT

input signal from an audio signal to the $V_{DD}/2$ DC voltage present on pin 28, and mutes the bridge-connected loads. Amp A -OUT and Amp B -OUT drive the headphones.

Figures 2 and 6 also show suggested headphone jack electrical connections. The jack is designed to mate with a three-wire plug. The plug's tip and ring should each carry one of the two stereo output signals, whereas the sleeve provides the return to Amp A +OUT. A headphone jack with one control pin contact is sufficient to drive the HP-IN pin when connecting headphones

A switch can replace the headphone jack contact pin. When a switch shorts the HP-IN pin to V_{DD} (An open switch contact will accomplish this because there is an internal pull-up resistor), the bridge-connected speakers are muted and Amp A -OUT and Amp B -OUT drive the stereo headphones. When a switch shorts the HP-IN pin to GND (pulling down the internal pull-up resistor), the LM4841 operates in bridge mode. If headphone drive is not needed, short the HP-IN pin to the -OUTB pin.

ESD Protection

As stated in the Absolute Maximum Ratings, pin 28 on the MT/MH packages and pin 25 on the LQ package, have a maximum ESD susceptibility rating of 6500V. For higher ESD voltages, the addition of a PCDN042 dual transil (from California Micro Devices), as shown in Figure 6, will provide additional protection.

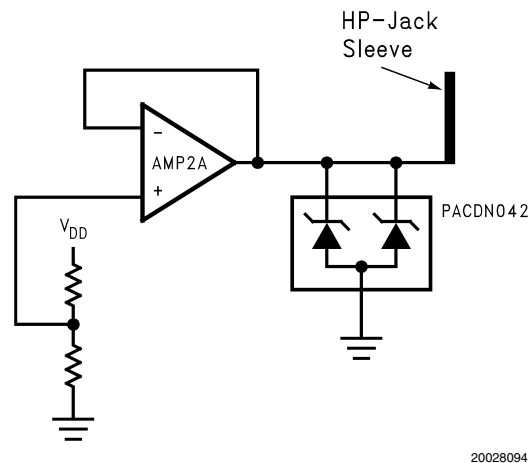

FIGURE 6. The PCDN042 provides additional ESD protection beyond the 6500V shown in the Absolute Maximum Ratings for the AMP2A output

GAIN SELECT FUNCTION (Bass Boost)

The LM4841 features selectable gain, using either internal or external feedback resistors. Either set of feedback resistors set the gain of the output amplifiers. The voltage applied to the GAIN SELECT pin controls which gain is selected. Applying V_{DD} to the GAIN SELECT pin selects the external gain mode. Applying 0V to the GAIN SELECT pin selects the internally set unity gain.

In some cases a designer may want to improve the low frequency response of the bridged amplifier or incorporate a bass boost feature. This bass boost can be useful in systems where speakers are housed in small enclosures. A resistor, R_{BA} , and a capacitor, C_{BA} , in parallel, can be placed in series with the feedback resistor of the bridged amplifier as seen in Figure 7.

Application Information (Continued)

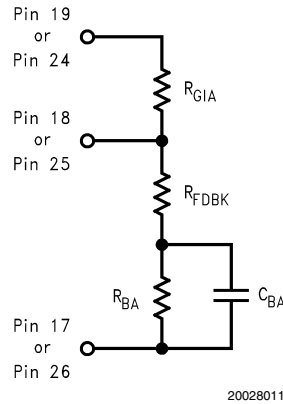

20028011

FIGURE 7. Low Frequency Enhancement (MT/MH PINOUT)

At low frequencies C_{BA} is a virtual open circuit and at high frequencies, its nearly zero ohm impedance shorts R_{BA} . The result is increased bridge-amplifier gain at low frequencies. The combination of R_{BA} and C_{BA} form a -6dB corner frequency at

$$f_C = 1/(2\pi R_{BA} C_{BA}) \quad (9)$$

The bridged-amplifier low frequency differential gain is:

$$A_{VD} = 2(R_{GFA} + R_{BA}) / R_{GIA} \quad (10)$$

Using the component values shown in *Figure 2* ($R_{GFA} = 20k\Omega$, $R_{BA} = 20k\Omega$, and $C_{BA} = 0.068\mu F$), a first-order, -6dB pole is created at 120Hz. Assuming $R_{GIA} = 20k\Omega$, the low frequency differential gain is 4. The input (C_{inA} and B) capacitor values must be selected for a low frequency response that covers the range of frequencies affected by the desired bass-boost operation.

DC VOLUME CONTROL

The LM4841 has an internal stereo volume control whose setting is a function of the DC voltage applied to the DC VOL CONTROL pin.

The LM4841 volume control consists of 31 steps that are individually selected by a variable DC voltage level on the volume control pin. The range of the steps, controlled by the DC voltage, are from 0dB - 78dB. Each gain step corresponds to a specific input voltage range, as shown in table 2, (on the following page.)

To minimize the effect of noise on the volume control pin, which can affect the selected gain level, hysteresis has been implemented. The amount of hysteresis corresponds to half of the step width, as shown in Volume Control Characterization Graph (DS200133-40).

For highest accuracy, the voltage shown in the 'recommended voltage' column of the table is used to select a desired gain. This recommended voltage is exactly halfway between the two nearest transitions to the next highest or next lowest gain levels.

The gain levels are 1dB/step from 0dB to -6dB, 2dB/step from -6dB to -36dB, 3dB/step from -36dB to -47dB, 4dB/step from -47dB to -51dB, 5dB/step from -51dB to -66dB, and 12dB to the last step at -78dB.

Application Information (Continued)**VOLUME CONTROL TABLE (Table 2)**

Gain (dB)	Voltage Range (% of Vdd)			Voltage Range (Vdd = 5)			Voltage Range (Vdd = 3)		
	Low	High	Recommended	Low	High	Recommended	Low	High	Recommended
0	77.5%	100.00%	100.000%	3.875	5.000	5.000	2.325	3.000	3.000
-1	75.0%	78.5%	76.875%	3.750	3.938	3.844	2.250	2.363	2.306
-2	72.5%	76.25%	74.375%	3.625	3.813	3.719	2.175	2.288	2.231
-3	70.0%	73.75%	71.875%	3.500	3.688	3.594	2.100	2.213	2.156
-4	67.5%	71.25%	69.375%	3.375	3.563	3.469	2.025	2.138	2.081
-5	65.0%	68.75%	66.875%	3.250	3.438	3.344	1.950	2.063	2.006
-6	62.5%	66.25%	64.375%	3.125	3.313	3.219	1.875	1.988	1.931
-8	60.0%	63.75%	61.875%	3.000	3.188	3.094	1.800	1.913	1.856
-10	57.5%	61.25%	59.375%	2.875	3.063	2.969	1.725	1.838	1.781
-12	55.0%	58.75%	56.875%	2.750	2.938	2.844	1.650	1.763	1.706
-14	52.5%	56.25%	54.375%	2.625	2.813	2.719	1.575	1.688	1.631
-16	50.0%	53.75%	51.875%	2.500	2.688	2.594	1.500	1.613	1.556
-18	47.5%	51.25%	49.375%	2.375	2.563	2.469	1.425	1.538	1.481
-20	45.0%	48.75%	46.875%	2.250	2.438	2.344	1.350	1.463	1.406
-22	42.5%	46.25%	44.375%	2.125	2.313	2.219	1.275	1.388	1.331
-24	40.0%	43.75%	41.875%	2.000	2.188	2.094	1.200	1.313	1.256
-26	37.5%	41.25%	39.375%	1.875	2.063	1.969	1.125	1.238	1.181
-28	35.0%	38.75%	36.875%	1.750	1.938	1.844	1.050	1.163	1.106
-30	32.5%	36.25%	34.375%	1.625	1.813	1.719	0.975	1.088	1.031
-32	30.0%	33.75%	31.875%	1.500	1.688	1.594	0.900	1.013	0.956
-34	27.5%	31.25%	29.375%	1.375	1.563	1.469	0.825	0.937	0.881
-36	25.0%	28.75%	26.875%	1.250	1.438	1.344	0.750	0.862	0.806
-39	22.5%	26.25%	24.375%	1.125	1.313	1.219	0.675	0.787	0.731
-42	20.0%	23.75%	21.875%	1.000	1.188	1.094	0.600	0.712	0.656
-45	17.5%	21.25%	19.375%	0.875	1.063	0.969	0.525	0.637	0.581
-47	15.0%	18.75%	16.875%	0.750	0.937	0.844	0.450	0.562	0.506
-51	12.5%	16.25%	14.375%	0.625	0.812	0.719	0.375	0.487	0.431
-56	10.0%	13.75%	11.875%	0.500	0.687	0.594	0.300	0.412	0.356
-61	7.5%	11.25%	9.375%	0.375	0.562	0.469	0.225	0.337	0.281
-66	5.0%	8.75%	6.875%	0.250	0.437	0.344	0.150	0.262	0.206
-78	0.0%	6.25%	0.000%	0.000	0.312	0.000	0.000	0.187	0.000

Application Information (Continued)

AUDIO POWER AMPLIFIER DESIGN

Audio Amplifier Design: Driving 1W into an 8Ω Load

The following are the desired operational parameters:

Power Output:	1 W _{RMS}
Load Impedance:	8Ω
Input Level:	1 V _{RMS}
Input Impedance:	20 kΩ
Bandwidth:	100 Hz–20 kHz ± 0.25 dB

The design begins by specifying the minimum supply voltage necessary to obtain the specified output power. One way to find the minimum supply voltage is to use the Output Power vs Supply Voltage curve in the **Typical Performance Characteristics** section. Another way, using Equation (10), is to calculate the peak output voltage necessary to achieve the desired output power for a given load impedance. To account for the amplifier's dropout voltage, two additional voltages, based on the Dropout Voltage vs Supply Voltage in the **Typical Performance Characteristics** curves, must be added to the result obtained by Equation (10). The result is Equation (11).

$$V_{\text{outpeak}} = \sqrt{(2R_L P_O)} \quad (11)$$

$$V_{DD} \geq (V_{\text{OUTPEAK}} + (V_{\text{ODTOP}} + V_{\text{ODBOT}})) \quad (12)$$

The Output Power vs Supply Voltage graph for an 8Ω load indicates a minimum supply voltage of 4.6V. This is easily met by the commonly used 5V supply voltage. The additional voltage creates the benefit of headroom, allowing the LM4841 to produce peak output power in excess of 1W without clipping or other audible distortion. The choice of supply voltage must also not create a situation that violates of maximum power dissipation as explained above in the **Power Dissipation** section.

After satisfying the LM4841's power dissipation requirements, the minimum differential gain needed to achieve 1W dissipation in an 8Ω load is found using Equation (12).

$$A_{VD} \geq \sqrt{(P_O R_L)} / (V_{IN}) = V_{\text{orms}} / V_{\text{inrms}} \quad (13)$$

Thus, a minimum overall gain of 2.83 allows the LM4841's to reach full output swing and maintain low noise and THD+N performance.

The last step in this design example is setting the amplifier's –6dB frequency bandwidth. To achieve the desired ±0.25dB pass band magnitude variation limit, the low frequency response must extend to at least one-fifth the lower bandwidth limit and the high frequency response must extend to at least five times the upper bandwidth limit. The gain variation for both response limits is 0.17dB, well within the ±0.25dB desired limit. The results are an

$$f_L = 100\text{Hz}/5 = 20\text{Hz} \quad (14)$$

and an

$$f_H = 20\text{kHz} \times 5 = 100\text{kHz} \quad (15)$$

As mentioned in the **Selecting Proper External Components** section, $R_{\text{in A and B}}$ and $C_{\text{in A and B}}$ create a highpass filter that sets the amplifier's lower bandpass frequency limit. Find the input coupling capacitor's value using Equation (14).

$$C_{\text{in A and B}} \geq 1/(2\pi R_{\text{in A and B}} f_L) \quad (16)$$

The result is

$$1/(2\pi * 20\text{k}\Omega * 20\text{Hz}) = 0.397\mu\text{F} \quad (17)$$

Use a 0.39μF capacitor, the closest standard value.

The product of the desired high frequency cutoff (100kHz in this example) and the differential gain A_{VD} , determines the upper passband response limit. With $A_{VD} = 3$ and $f_H = 100\text{kHz}$, the closed-loop gain bandwidth product (GBWP) is 300kHz. This is less than the LM4841's 3.5MHz GBWP. With this margin, the amplifier can be used in designs that require more differential gain while avoiding performance, restricting bandwidth limitations.

Recommended Printed Circuit Board Layout

Figures 8 through 14 show the recommended PC board layout that is optimized for the LM4841 and associated external components. This circuit is designed for use with an external 5V supply and 8Ω speakers.

This circuit board is easy to use. Apply 5V and ground to the board's V_{DD} and GND pads, respectively. Connect 8Ω speakers between the board's –OUTA and +OUTA and –OUTB and +OUTB pads.

LM4841LQ Demo Board Artworks

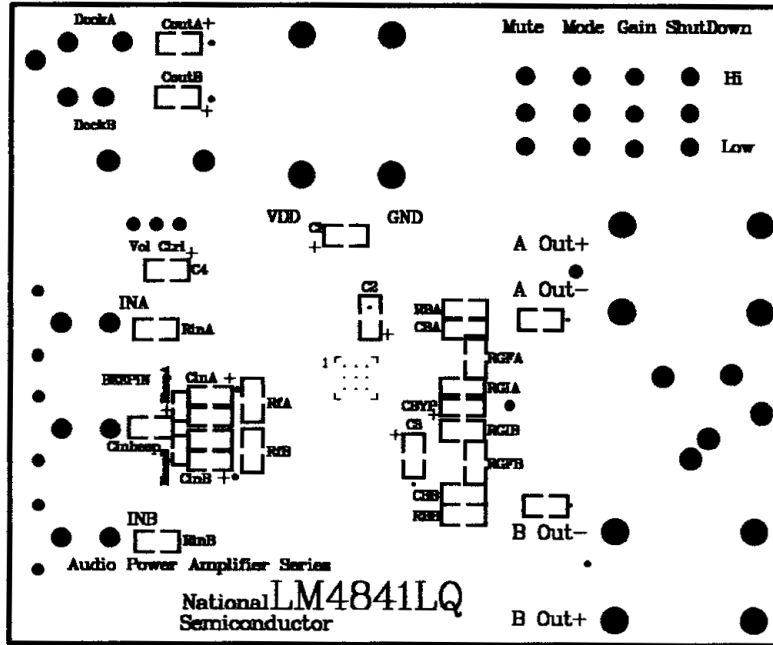

20028098

FIGURE 8. Top Layer SilkScreen

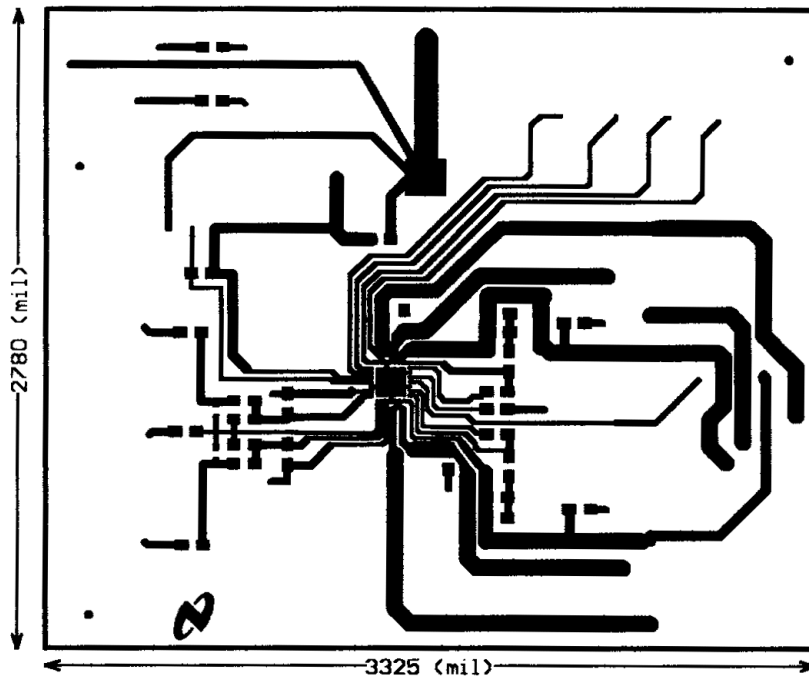

20028099

FIGURE 9. Top Layer LQ

LM4841LQ Demo Board Artworks (Continued)

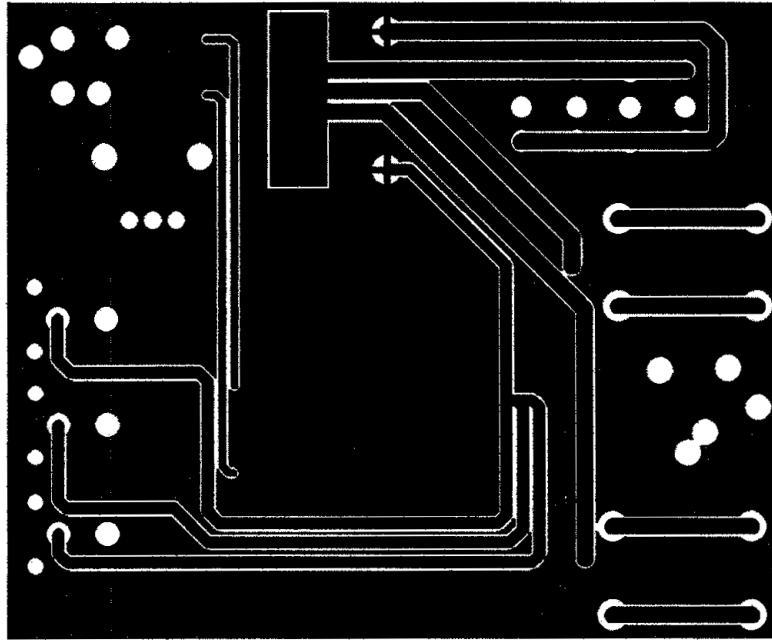

200280A0

FIGURE 10. Bottom Layer LQ

Analog Audio LM4841LQ Eval Board
Assembly Part Number: 5510118313-001
Revision: A
Bill of Material

Item	Part Number	Part Description	Qty	Ref Designator	Remark
1	551011373-001	LM4841 Eval Board PCB etch 001	1		
10	482911373-001	LM4841LQ	1		
20	151911368-001	Cer Cap 0.068 μ F 50V 10% 1206	2	CBA, CBB	
25	152911368-001	Tant Cap 0.1 μ F 10V 10% Size = A 3216	3	C2, C3, C4	
26	152911368-002	Tant Cap 0.33 μ F 10V 10% Size = A 3216	3	CinA, CinB, Cinbeep	
27	152911368-003	Tant Cap 1 μ F 16V 10% Size = A 3216	3	C _{BYP} , CoutA, CoutB	
28	152911368-004	Tant Cap 10 μ F 10V 10% Size = C 6032	1	C1	
31	472911368-002	Res 20K Ohm 1/8W 1% 1206	10	R _{INAandB} , R _{GFAandB} , RBA, RBB, R _{GIAandB} , R _{FAandB}	
33	472911368-004	Res 200K Ohm 1/16W 1% 0603	2	R _{BeepAandB}	
40	131911368-001	Stereo Headphone Jack W/ Switch	1		Switchcraft 35RAPC4BH3
41	131911368-002	Slide Switch	4	mute, mode, Gain, SD	Mouser # 10SP003
42	131911368-003	Potentiometer	1	Volume Control	Mouser # 317-2090-100K
43	131911368-004	RCA Jack	3	InA, InB, BeepIn	Mouser # 16PJ097
44	131911368-005	Banana Jack, Black	3	GND, AOUT-, BOUT-	Mouser # ME164-6219
45	131911368-006	Banana Jack, Red	3	VDD, AOUT+, BOUT+	Mouser # ME164-6218

LM4841 MT & MH Demo Board Artworks

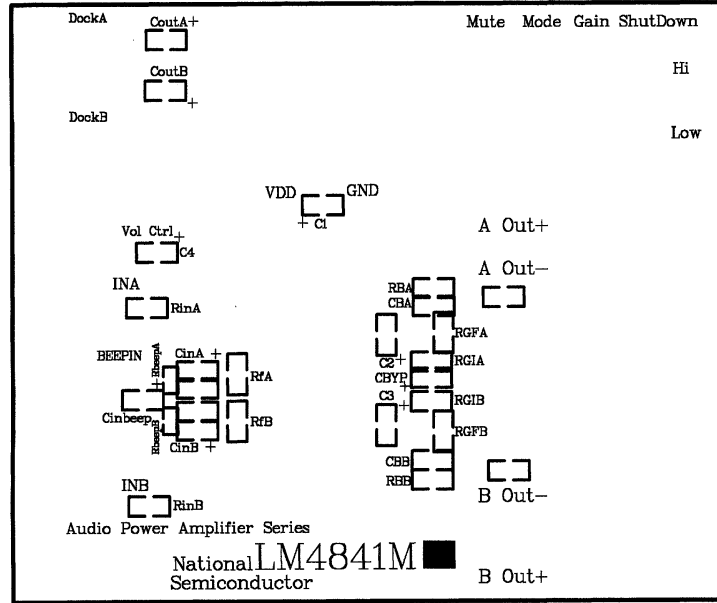

20028088

FIGURE 11. Top Layer SilkScreen

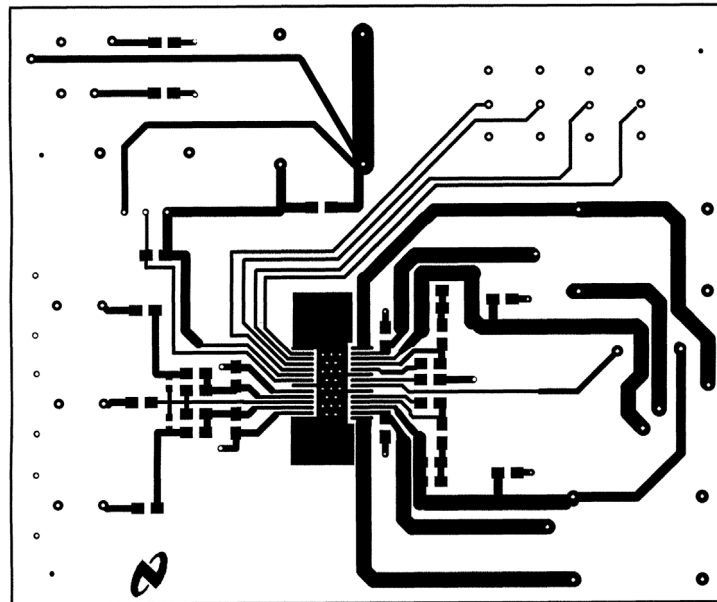

20028089

FIGURE 12. Top Layer TSSOP

LM4841 MT & MH Demo Board Artworks (Continued)

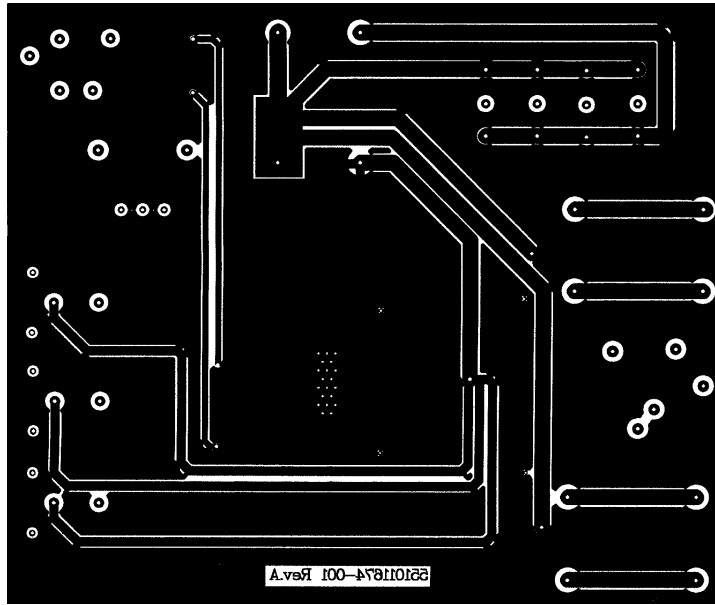

20028090

FIGURE 13. Bottom Layer TSSOP

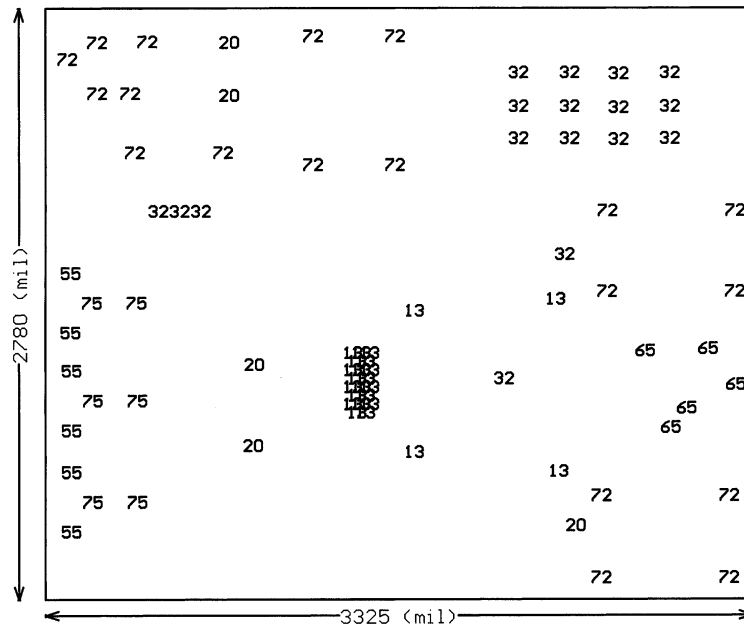

20028091

FIGURE 14. Drill Drawing

Analog Audio LM4841 MSOP Eval Board
 Assembly Part Number: 980011373-100
 Revision: A
 Bill of Material

Item	Part Number	Part Description	Qty	Ref Designator	Remark
1	551011373-001	LM4841 Eval Board PCB etch 001	1		
10	482911373-001	LM4841 MSOP	1		
20	151911368-001	Cer Cap 0.068 μ F 50V 10% 1206	2	CBA, CBB	
25	152911368-001	Tant Cap 0.1 μ F 10V 10% Size = A 3216	3	C2, C3, C4	
26	152911368-002	Tant Cap 0.33 μ F 10V 10% Size = A 3216	3	CinA, CinB, Cinbeep	
27	152911368-003	Tant Cap 1 μ F 16V 10% Size = A 3216	3	C _{BYP} , CoutA, CoutB	
28	152911368-004	Tant Cap 10 μ F 10V 10% Size = C 6032	1	C1	
31	472911368-002	Res 20K Ohm 1/8W 1% 1206	10	R _{INAandB} , R _{GFAandB} , R _{BA} , R _{BB} , R _{GIAandB} , R _{FAandB}	
33	472911368-004	Res 200K Ohm 1/16W 1% 0603	2	R _{BeepAandB}	
40	131911368-001	Stereo Headphone Jack W/ Switch	1		Switchcraft 35RAPC4BH3
41	131911368-002	Slide Switch	4	mute, mode, Gain, SD	Mouser # 10SP003
42	131911368-003	Potentiometer	1	Volume Control	Mouser # 317-2090-100K
43	131911368-004	RCA Jack	3	InA, InB, BeepIn	Mouser # 16PJ097
44	131911368-005	Banana Jack, Black	3	GND, AOUT-, BOUT-	Mouser # ME164-6219
45	131911368-006	Banana Jack, Red	3	VDD, AOUT+, BOUT+	Mouser # ME164-6218

Physical Dimensions inches (millimeters) unless otherwise noted

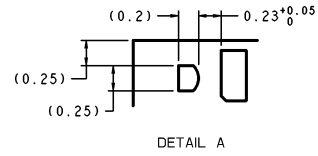
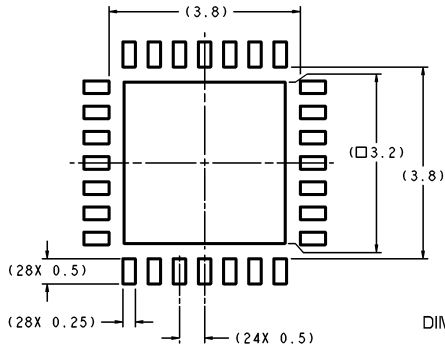

DIMENSIONS ARE IN MILLIMETERS

RECOMMENDED LAND PATTERN
1:1 RATION WITH PKG SOLDER PADS

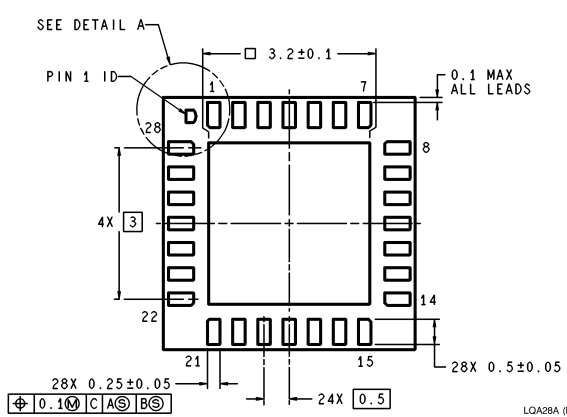
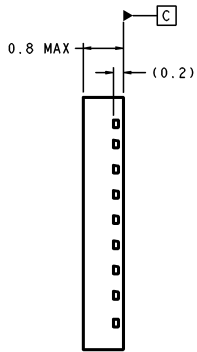
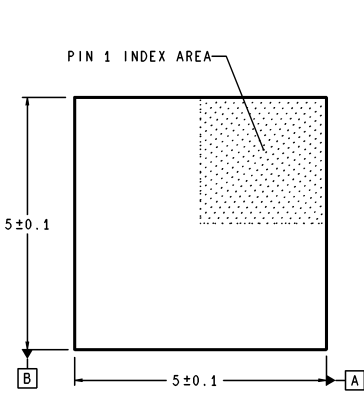

LQA28A (Rev B)

LLP Package
Order Number LM4841LQ
NS Package Number LQA028A for Exposed-DAP LLP

Physical Dimensions inches (millimeters) unless otherwise noted (Continued)

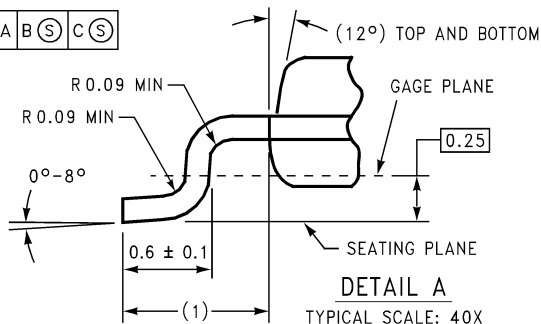
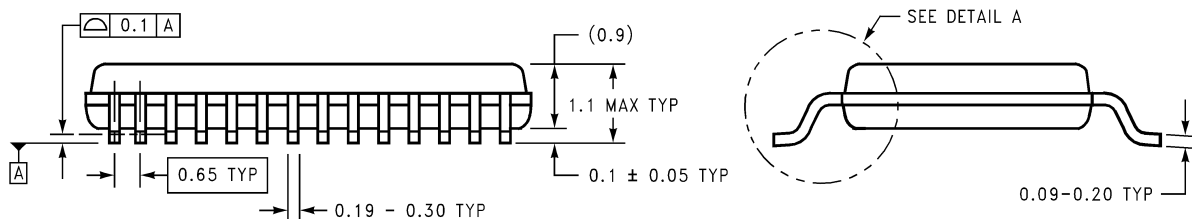
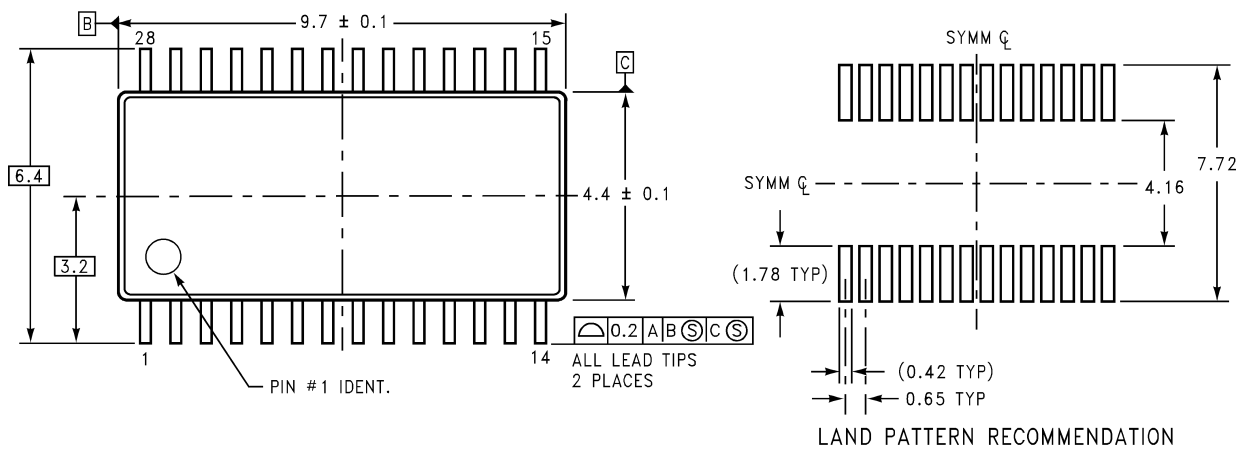

MTC28 (REV A)

TSSOP Package
Order Number LM4841MT
NS Package Number MTC28 for TSSOP

Physical Dimensions inches (millimeters) unless otherwise noted (Continued)

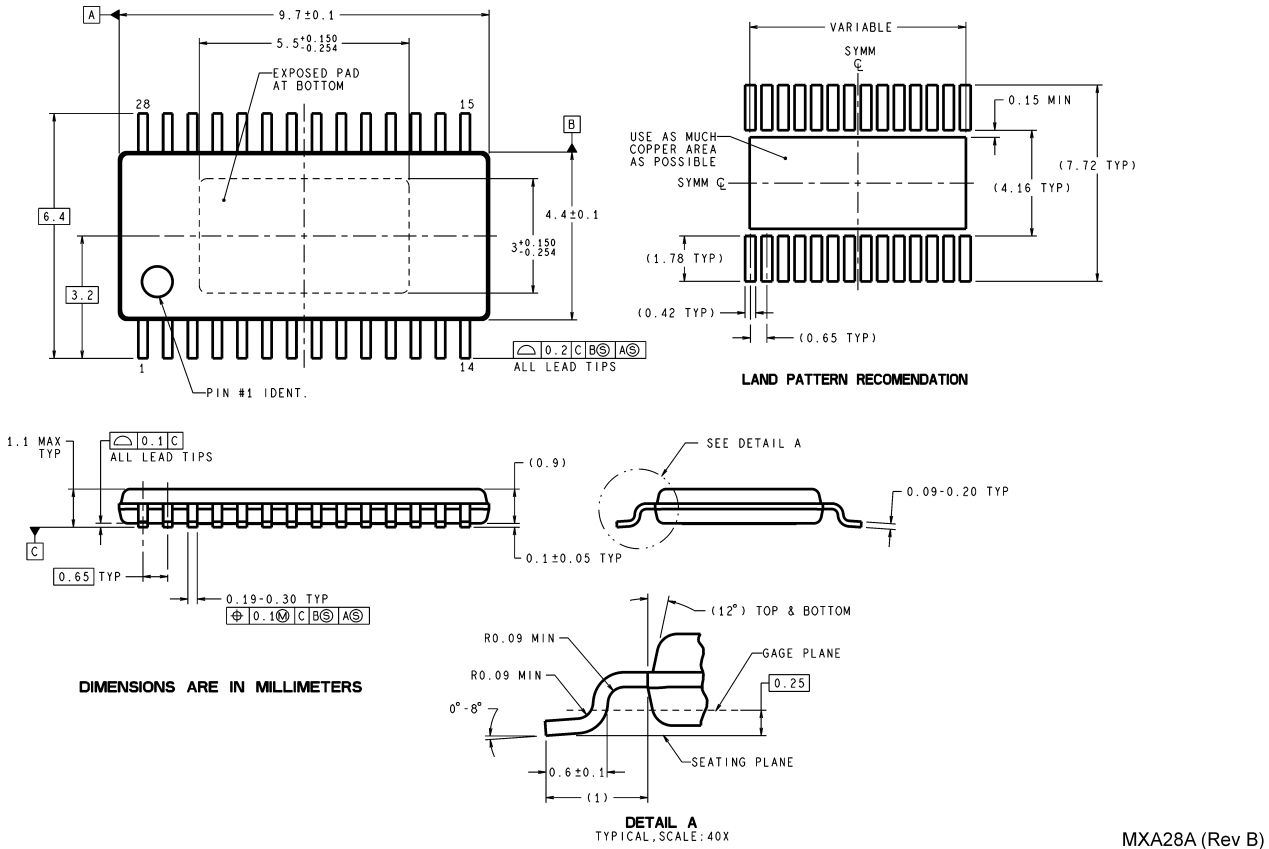

Exposed-DAP TSSOP Package
Order Number LM4841MH
NS Package Number MXA28A for Exposed-DAP TSSOP

MXA28A (Rev B)

LIFE SUPPORT POLICY

NATIONAL'S PRODUCTS ARE NOT AUTHORIZED FOR USE AS CRITICAL COMPONENTS IN LIFE SUPPORT DEVICES OR SYSTEMS WITHOUT THE EXPRESS WRITTEN APPROVAL OF THE PRESIDENT AND GENERAL COUNSEL OF NATIONAL SEMICONDUCTOR CORPORATION. As used herein:

1. Life support devices or systems are devices or systems which, (a) are intended for surgical implant into the body, or (b) support or sustain life, and whose failure to perform when properly used in accordance with instructions for use provided in the labeling, can be reasonably expected to result in a significant injury to the user.
2. A critical component is any component of a life support device or system whose failure to perform can be reasonably expected to cause the failure of the life support device or system, or to affect its safety or effectiveness.

 **National Semiconductor Corporation**
Americas
Email: support@nsc.com

National Semiconductor Europe
Fax: +49 (0) 180-530 85 86
Email: europe.support@nsc.com
Deutsch Tel: +49 (0) 69 9508 6208
English Tel: +44 (0) 870 24 0 2171
Français Tel: +33 (0) 1 41 91 8790

National Semiconductor Asia Pacific Customer Response Group
Tel: 65-2544466
Fax: 65-2504466
Email: ap.support@nsc.com

National Semiconductor Japan Ltd.
Tel: 81-3-5639-7560
Fax: 81-3-5639-7507

www.national.com