

LM3490

100 mA, SOT-23, Quasi Low-Dropout Linear Voltage Regulator with Logic-Controlled ON/OFF

General Description

The LM3490 is an integrated linear voltage regulator. It features operation from an input as high as 30V and a guaranteed maximum dropout of 1.2V at the full 100 mA load. Standard packaging for the LM3490 is the 5-lead SOT-23 package. A logic-controlled ON/OFF feature makes the LM3490 ideal for powering subsystems ON and OFF as needed.

The 5, 12, and 15V members of the LM3490 series are intended as tiny alternatives to industry standard LM78LXX series and similar devices. The 1.2V quasi low dropout of LM3490 series devices makes them a nice fit in many applications where the 2 to 2.5V dropout of LM78LXX series devices precludes their (LM78LXX series devices) use.

The LM3490 series features a 3.3V member. The SOT packaging and quasi low dropout features of the LM3490 series converge in this device to provide a very nice, very tiny 3.3V, 100 mA bias supply that regulates directly off the system 5V±5% power supply.

Key Specifications

- 30V maximum input for operation
- 1.2V guaranteed maximum dropout over full load and temperature ranges
- 100 mA guaranteed load current
- ±5% guaranteed output voltage tolerance over full load and temperature ranges
- -40 to +125°C junction temperature range for operation

Features

- 3.3, 5, 12, and 15V versions available
- Logic-controlled ON/OFF
- Packaged in the tiny 5-lead SOT-23 package

Applications

- Tiny alternative to LM78LXX series and similar devices
- Tiny 5V±5% to 3.3V, 100 mA converter
- Post regulator for switching DC/DC converter
- Bias supply for analog circuits

Typical Application Circuit

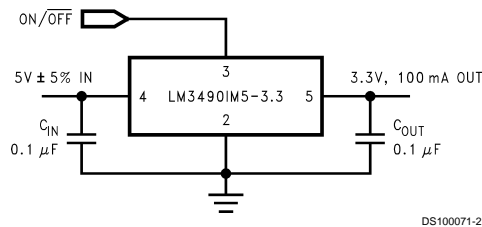

Connection Diagram

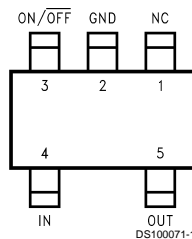

Top View
SOT-23 Package
5-Lead, Molded-Plastic Small-Outline Transistor (SOT) Package
Package Code MA05B (Note 1)

Ordering Information

Output Voltage (V)	Order Number (Note 2)	Package Marking (Note 3)	Comments
3.3	LM3490IM5-3.3	L78B	250 Units on Tape and Reel
3.3	LM3490IM5X-3.3	L78B	3k Units on Tape and Reel
5	LM3490IM5-5.0	L79B	250 Units on Tape and Reel
5	LM3490IM5X-5.0	L79B	3k Units on Tape and Reel
12	LM3490IM5-12	L80B	250 Units on Tape and Reel
12	LM3490IM5X-12	L80B	3k Units on Tape and Reel
15	LM3490IM5-15	L81B	250 Units on Tape and Reel
15	LM3490IM5X-15	L81B	3k Units on Tape and Reel

Absolute Maximum Ratings (Note 4)

If Military/Aerospace specified devices are required, please contact the National Semiconductor Sales Office/Distributors for availability and specifications.

Input Voltage (IN to GND)	35V
Voltage ON/OFF to GND	5.5V
Power Dissipation (Note 5)	400 mW
Junction Temp. (T _J) (Note 5)	+150°C
Ambient Storage Temp.	-65 to +150°C
Soldering Time, Temp. (Note 6)	
Wave	4sec., 260°C
Infrared	10sec., 240°C
Vapor Phase	75sec., 219°C

ESD (Note 7)

ON/OFF	1.0kV
All Other Pins	2.0kV

Operating Ratings (Note 4)

Maximum Input Voltage (IN to GND)	30V
Voltage ON/OFF to GND	0 to 5V
Junction Temperature (T _J)	-40 to +125°C
Maximum Power Dissipation (Note 8)	300 mW

Electrical Characteristics

LM3490-3.3, LM3490-5.0

V_{IN} = V_{NOM} + 1.5V unless otherwise noted. Typical and limits appearing in normal type apply for T_A = T_J = 25°C. Limits appearing in boldface type apply over the entire junction temperature range for operation, -40 to +125°C. (Notes 9, 10, 11)

Nominal Output Voltage (V _{NOM})			3.3V		5.0V		Units
Symbol	Parameter	Conditions	Typical	Limit	Typical	Limit	
V _{OUT}	Output Voltage	1 mA ≤ I _{OUT} ≤ 100 mA	3.30	3.17 3.14 3.43 3.46	5.00	4.80 4.75 5.20 5.25	V V(min) V(min) V(max) V(max)
ΔV _{OUT}	Line Regulation	V _{NOM} + 1.5V ≤ V _{IN} ≤ 30V, I _{OUT} = 1 mA	7	25	9	25	mV mV(max)
ΔV _{OUT}	Load Regulation	10 mA ≤ I _{OUT} ≤ 100 mA	15	40	15	40	mV mV(max)
I _{GND}	Ground Pin Current	V _{NOM} + 1.5V ≤ V _{IN} ≤ 30V, No Load V _{ON/OFF} = 5V	2	4	2	4	mA mA(max)
		V _{ON/OFF} = 0V	0.1	5	0.1	5	μA μA(max)
V _{IN} - V _{OUT}	Dropout Voltage	I _{OUT} = 10 mA	0.7	0.9 1.0	0.7	0.9 1.0	V V(max) V(max)
		I _{OUT} = 100 mA	0.9	1.1 1.2	0.9	1.1 1.2	V V(max) V(max)
e _n	Output Noise Voltage	V _{IN} = 10V, Bandwidth: 10 Hz to 100 kHz	100		150		μV _{rms}
V _{IL}	Maximum Low Level Input Voltage at ON/OFF			0.2		0.2	V(max)
V _{IH}	Minimum High Level Input Voltage at ON/OFF			2.0		2.0	V(min)
I _{IL}		V _{ON/OFF} = 0V		-1		-1	μA(max)
I _{IH}		V _{ON/OFF} = 5V	1	20	1	20	μA μA(max)

LM3490-12, LM3490-15

$V_{IN} = V_{NOM} + 1.5V$ unless otherwise noted. Typical and limits appearing in normal type apply for $T_A = T_J = 25^\circ C$. Limits appearing in boldface type apply over the entire junction temperature range for operation, -40 to $+125^\circ C$. (Notes 9, 10, 11)

Nominal Output Voltage (V_{NOM})			12V		15V		Units
Symbol	Parameter	Conditions	Typical	Limit	Typical	Limit	
V_{OUT}	Output Voltage	$1\text{ mA} \leq I_{OUT} \leq 100\text{ mA}$	12.00	11.52 11.40 12.48 12.60	15.00	14.40 14.25 15.60 15.75	V V(min) V(min) V(max) V(max)
ΔV_{OUT}	Line Regulation	$V_{NOM} + 1.5V \leq V_{IN} \leq 30V$, $I_{OUT} = 1\text{ mA}$	14	40	16	40	mV mV(max)
ΔV_{OUT}	Load Regulation	$10\text{ mA} \leq I_{OUT} \leq 100\text{ mA}$	36	60	45	75	mV mV(max)
I_{GND}	Ground Pin Current	$V_{NOM} + 1.5V \leq V_{IN} \leq 30V$, No Load $V_{ON/OFF} = 5V$	2	4	2	4	mA mA(max)
		$V_{ON/OFF} = 0V$	0.1	5	0.1	5	μA μA (max)
$V_{IN} - V_{OUT}$	Dropout Voltage	$I_{OUT} = 10\text{ mA}$	0.7	0.9 1.0	0.7	0.9 1.0	V V(max) V(max)
		$I_{OUT} = 100\text{ mA}$	0.9	1.1 1.2	0.9	1.1 1.2	V V(max) V(max)
e_n	Output Noise Voltage	$V_{IN} = 10V$, Bandwidth: 10 Hz to 100 kHz	360		450		μV_{rms}
V_{IL}	Maximum Low Level Input Voltage at ON/OFF			0.2		0.2	V(max)
V_{IH}	Minimum High Level Input Voltage at ON/OFF			2.0		2.0	V(min)
I_{IL}		$V_{ON/OFF} = 0V$		-1		-1	μA (max)
I_{IH}		$V_{ON/OFF} = 5V$	1	20	1	20	μA μA (max)

Note 1: The package code MA05B is internal to National Semiconductor Corporation and indicates a specific version of the SOT-23 package and associated mechanical drawings.

Note 2: The suffix "I" indicates the junction temperature range for operation is the industrial temperature range, -40 to $+125^\circ C$. The suffix "M5" indicates the die is packaged in the 5-lead SOT-23 package. The suffix "X" indicates the devices will be supplied in blocks of 3k units as opposed to blocks of 250 units.

Note 3: Because the entire part number does not fit on the SOT-23 package, the SOT-23 package is marked with this code instead of the part number.

Note 4: Absolute Maximum Ratings are limits beyond which damage to the device may occur. Operating Ratings are conditions under which operation of the device is guaranteed. Operating Ratings do not imply guaranteed performance limits. For guaranteed performance limits and associated test conditions, see the Electrical Characteristics tables.

Note 5: The Absolute Maximum power dissipation depends on the ambient temperature and can be calculated using $P = (T_J - T_A)/\theta_{JA}$ where T_J is the junction temperature, T_A is the ambient temperature, and θ_{JA} is the junction-to-ambient thermal resistance. The 400 mW rating results from substituting the Absolute Maximum junction temperature, $150^\circ C$, for T_J , $50^\circ C$ for T_A , and $250^\circ C/W$ for θ_{JA} . More power can be safely dissipated at lower ambient temperatures. Less power can be safely dissipated at higher ambient temperatures. The Absolute Maximum power dissipation can be increased by 4 mW for each $^\circ C$ below $50^\circ C$ ambient. It must be derated by 4 mW for each $^\circ C$ above $50^\circ C$ ambient. A θ_{JA} of $250^\circ C/W$ represents the worst-case condition of no heat sinking of the 5-lead plastic SOT-23 package. Heat sinking enables the safe dissipation of more power. The LM3490 actively limits its junction temperature to about $150^\circ C$.

Note 6: Times shown are dwell times. Temperatures shown are dwell temperatures. For detailed information on soldering plastic small-outline packages, refer to the *Packaging Databook* available from National Semiconductor Corporation.

Note 7: For testing purposes, ESD was applied using the human-body model, a 100 pF capacitor discharged through a 1.5 k Ω resistor.

Note 8: As with the Absolute Maximum power dissipation, the maximum power dissipation for operation depends on the ambient temperature. The 300 mW rating appearing under Operating Ratings results from substituting the maximum junction temperature for operation, $125^\circ C$, for T_J , $50^\circ C$ for T_A , and $250^\circ C/W$ for θ_{JA} in $P = (T_J - T_A)/\theta_{JA}$. More power can be dissipated at lower ambient temperatures. Less power can be dissipated at higher ambient temperatures. The maximum power dissipation for operation appearing under Operating Ratings can be increased by 4 mW for each $^\circ C$ below $50^\circ C$ ambient. It must be derated by 4 mW for each $^\circ C$ above $50^\circ C$ ambient. A θ_{JA} of $250^\circ C/W$ represents the worst-case condition of no heat sinking of the 5-lead plastic SOT-23 package. Heat sinking enables the dissipation of more power during operation.

LM3490-12, LM3490-15 (Continued)

Note 9: A typical is the center of characterization data taken with $T_A = T_J = 25^\circ\text{C}$. Typical values are not guaranteed.

Note 10: All limits are guaranteed. All electrical characteristics having room-temperature limits are tested during production with $T_A = T_J = 25^\circ\text{C}$. All hot and cold limits are guaranteed by correlating the electrical characteristics to process and temperature variations and applying statistical process control.

Note 11: All voltages except dropout are with respect to the voltage at the GND pin.

Typical Performance Characteristics Unless indicated otherwise, $V_{IN} = V_{NOM} + 1.5V$, $C_{IN} = 0.1 \mu F$, $C_{OUT} = 0.1 \mu F$, and $T_A = 25^\circ C$.

Dropout Voltage vs Load Current

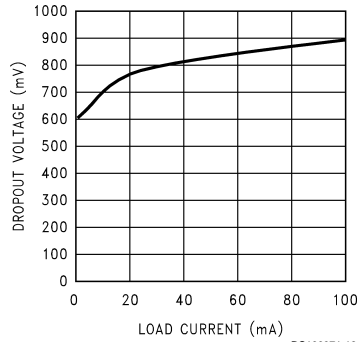

DS100071-19

Dropout Voltage vs Junction Temperature

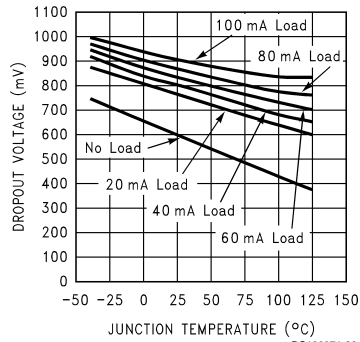

DS100071-20

Ground Pin Current vs Input Voltage

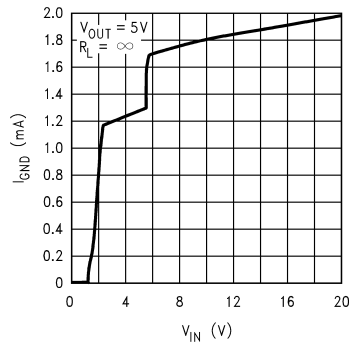

DS100071-9

Ground Pin Current vs Input Voltage

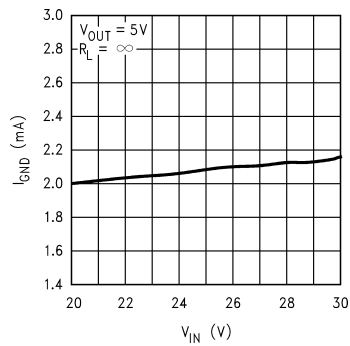

DS100071-10

Ground Pin Current vs Load Current

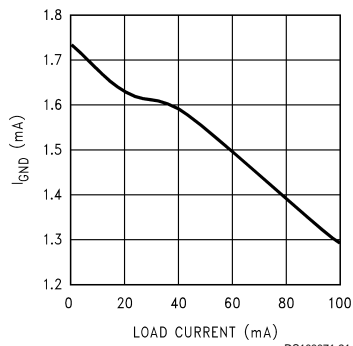

DS100071-21

Ground Pin Current vs Junction Temperature

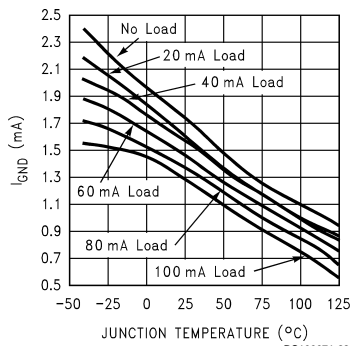

DS100071-22

Typical Performance Characteristics Unless indicated otherwise, $V_{IN} = V_{NOM} + 1.5V$, $C_{IN} = 0.1 \mu F$, $C_{OUT} = 0.1 \mu F$, and $T_A = 25^\circ C$. (Continued)

Input Current vs Input Voltage

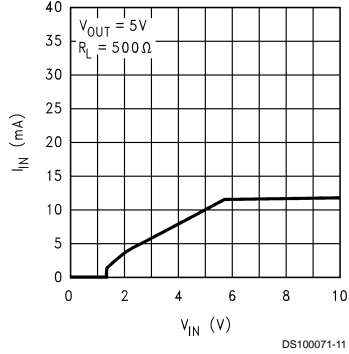

Input Current vs Input Voltage

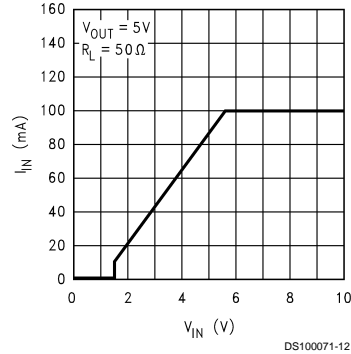

Line Transient Response

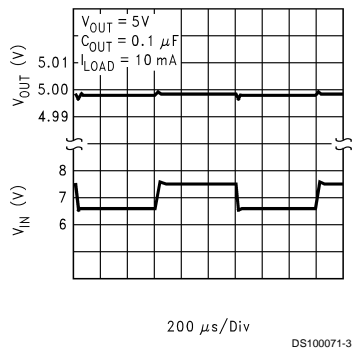

Line Transient Response

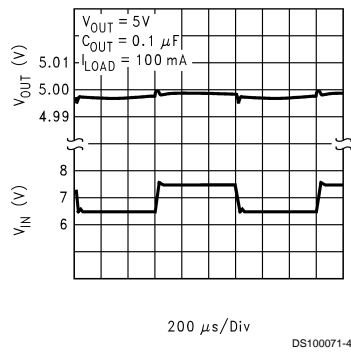

Load Transient Response

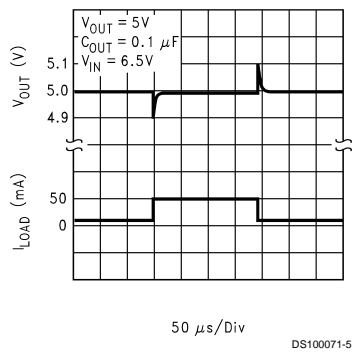

Load Transient Response

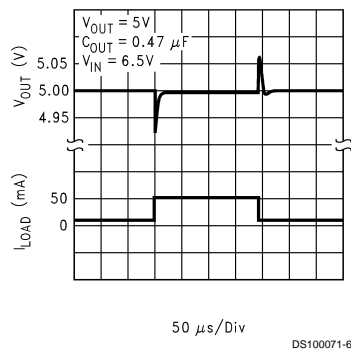

Typical Performance Characteristics Unless indicated otherwise, $V_{IN} = V_{NOM} + 1.5V$, $C_{IN} = 0.1 \mu F$, $C_{OUT} = 0.1 \mu F$, and $T_A = 25^\circ C$. (Continued)

Load Transient Response

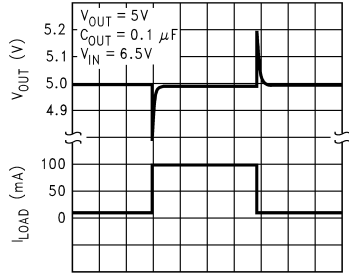

50 μs /Div
DS100071-7

Load Transient Response

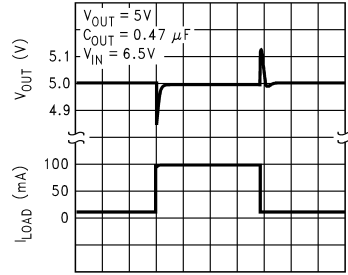

50 μs /Div
DS100071-8

Output Voltage vs Input Voltage

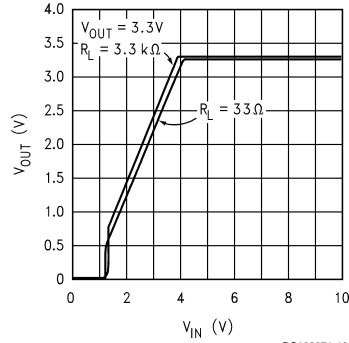

DS100071-13

Output Voltage vs Input Voltage

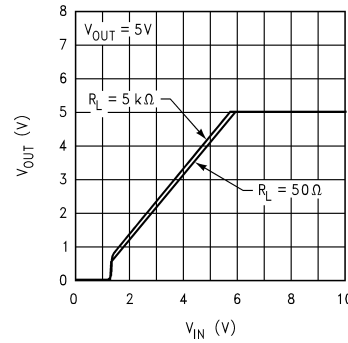

DS100071-14

Output Voltage vs Input Voltage

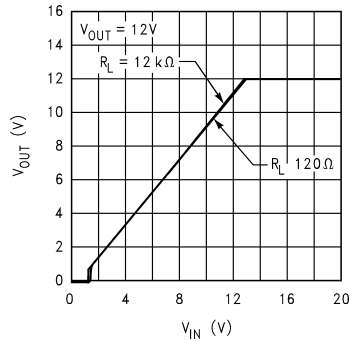

DS100071-15

Output Voltage vs Input Voltage

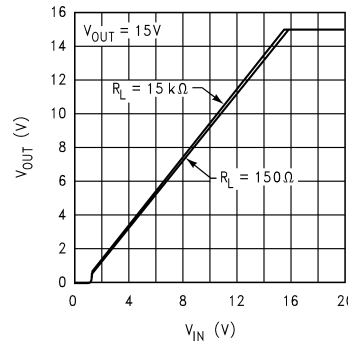

DS100071-16

Typical Performance Characteristics Unless indicated otherwise, $V_{IN} = V_{NOM} + 1.5V$, $C_{IN} = 0.1 \mu F$, $C_{OUT} = 0.1 \mu F$, and $T_A = 25^\circ C$. (Continued)

Output Short-Circuit Current

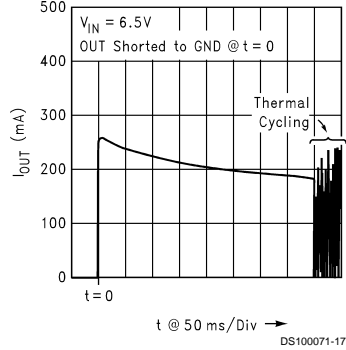

Output Short-Circuit Current

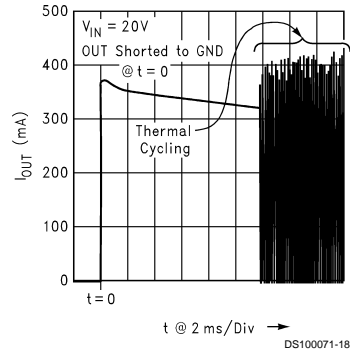

Power Supply Rejection Ratio

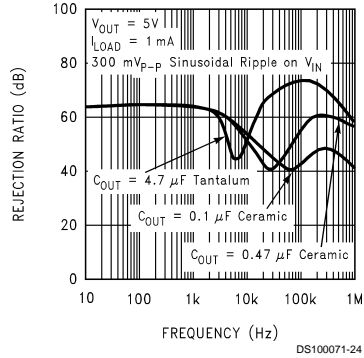

Power Supply Rejection Ratio

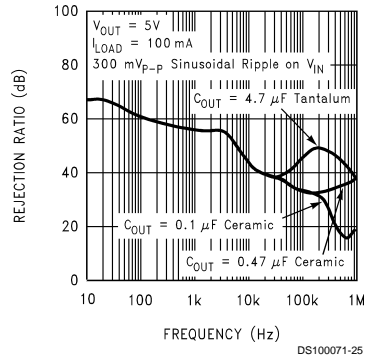

DC Load Regulation

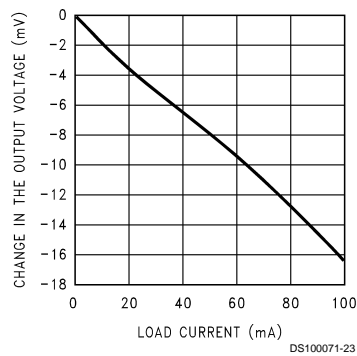

LM3490 100 mA, SOT-23, Quasi Low-Dropout Linear Voltage Regulator with Logic-Controlled ON/OFF

Physical Dimensions inches (millimeters) unless otherwise noted

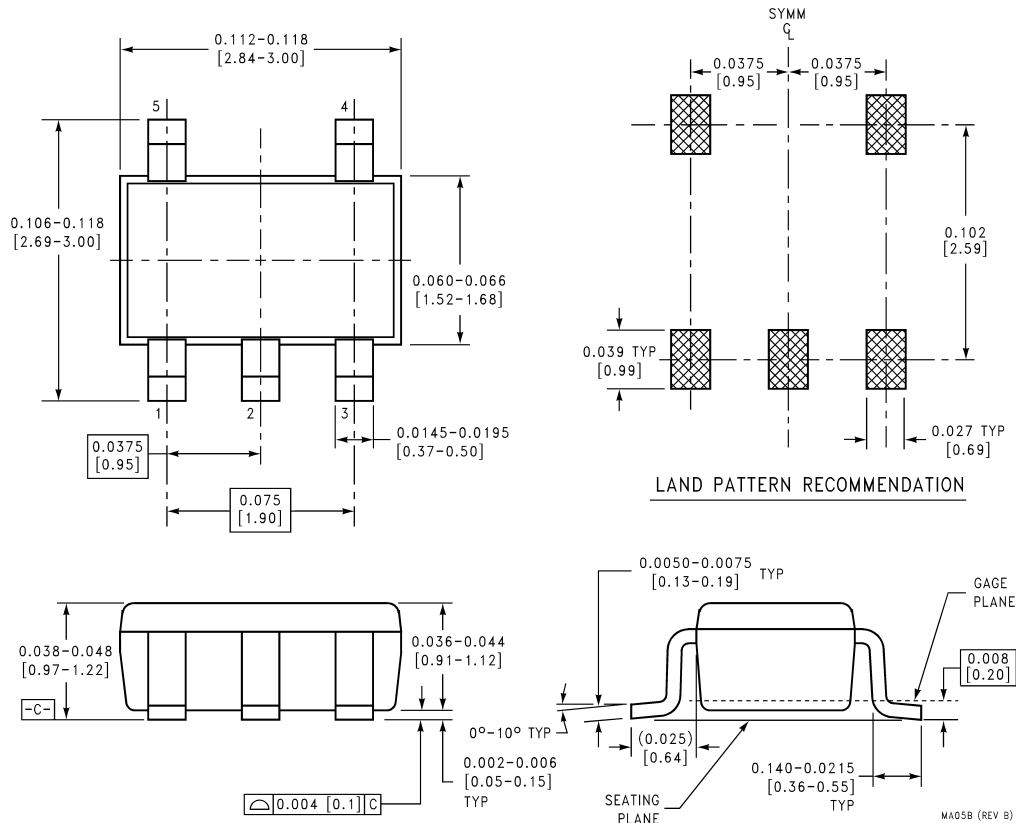

SOT-23 Package
5-Lead Small-Outline Package (M5)
For Ordering, Refer to Ordering Information Table
NS Package Number MA05B

LIFE SUPPORT POLICY

NATIONAL'S PRODUCTS ARE NOT AUTHORIZED FOR USE AS CRITICAL COMPONENTS IN LIFE SUPPORT DEVICES OR SYSTEMS WITHOUT THE EXPRESS WRITTEN APPROVAL OF THE PRESIDENT AND GENERAL COUNSEL OF NATIONAL SEMICONDUCTOR CORPORATION. As used herein:

1. Life support devices or systems are devices or systems which, (a) are intended for surgical implant into the body, or (b) support or sustain life, and whose failure to perform when properly used in accordance with instructions for use provided in the labeling, can be reasonably expected to result in a significant injury to the user.
2. A critical component is any component of a life support device or system whose failure to perform can be reasonably expected to cause the failure of the life support device or system, or to affect its safety or effectiveness.

National Semiconductor Corporation
Americas
Tel: 1-800-272-9959
Fax: 1-800-737-7018
Email: support@nsc.com

National Semiconductor Europe
Fax: +49 (0) 1 80-530 85 86
Email: europe.support@nsc.com
Deutsch Tel: +49 (0) 1 80-530 85 85
English Tel: +49 (0) 1 80-532 78 32
Français Tel: +49 (0) 1 80-532 93 58
Italiano Tel: +49 (0) 1 80-534 16 80

National Semiconductor Asia Pacific Customer Response Group
Tel: 65-2544466
Fax: 65-2504466
Email: sea.support@nsc.com

National Semiconductor Japan Ltd.
Tel: 81-3-5639-7560
Fax: 81-3-5639-7507

www.national.com

National does not assume any responsibility for use of any circuitry described, no circuit patent licenses are implied and National reserves the right at any time without notice to change said circuitry and specifications.