

### General Description

The MIC29510 and MIC29512 are high-current, high-accuracy, low-dropout voltage regulators featuring fast transient recovery from input voltage surges and output load current changes. These regulators use a PNP pass element that features Micrel's proprietary Super  $\beta$  PNP™ process.

The MIC29510/2 is available in two versions: the three pin fixed output MIC29510 and the five pin adjustable output voltage MIC29512. All versions are fully protected against overcurrent faults, reversed input polarity, reversed lead insertion, overtemperature operation, and positive and negative transient voltage spikes.

A TTL compatible enable (EN) control pin supports external on/off control. If on/off control is not required, the device may be continuously enabled by connecting EN to IN.

The MIC29510/2 is available in the standard three and five pin TO-220 package with an operating junction temperature range of 0°C to +125°C.

*For applications requiring even lower dropout voltage, input voltage greater than 16V, or an error flag, see the MIC29500/29501/29502/29503.*

### Features

- Fast transient response
- 5A current capability
- 700mV dropout voltage at full load
- Low ground current
- Accurate 1% guaranteed tolerance
- “Zero” current shutdown mode (MIC29512)
- Fixed voltage and adjustable versions

### Applications

- Pentium™ and Power PC™ processor supplies
- High-efficiency “green” computer systems
- High-efficiency linear power supplies
- High-efficiency switching supply post regulator
- Battery-powered equipment

### Ordering Information

Part Number	Temp. Range*	Voltage	Current	Package
MIC29510-3.3BT	0°C to +125°C	3.3V	5.0A	TO-220-3
MIC29510-5.0BT	0°C to +125°C	5.0V	5.0A	TO-220-3
MIC29512BT	0°C to +125°C	Adj.	5.0A	TO-220-5

\* Junction Temperature

### Typical Application

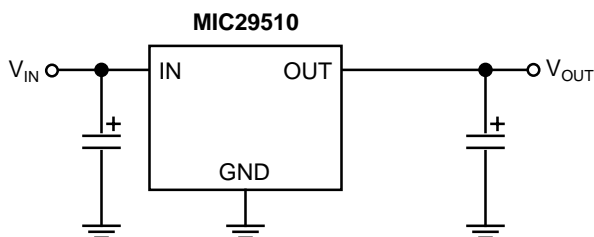

Fixed Regulator Configuration

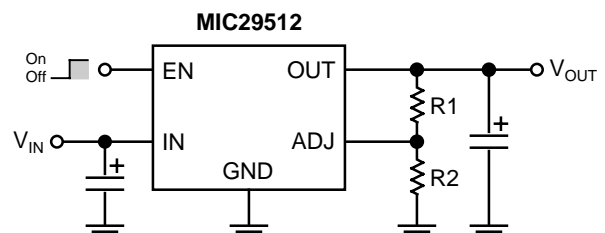

$$V_{OUT} = 1.240 \left( \frac{R1}{R2} + 1 \right)$$

Adjustable Regulator Configuration

## Pin Configuration

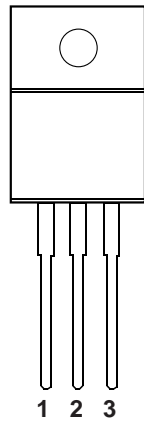

MIC29510BT

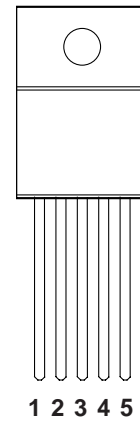

MIC29512BT

On all devices, the Tab is grounded.

## Pin Description

### 3-Pin TO-220 (MIC29510)

Pin Number	Pin Name	Pin Function
1	IN	Unregulated Input: +16V maximum supply.
2	GND	Ground: Internally connected to tab (ground).
3	OUT	Regulated Output

### 5-Pin TO-220 (MIC29512)

Pin Number	Pin Name	Pin Function
1	EN	Enable (Input): Logic-level ON/OFF control.
2	IN	Unregulated Input: +16V maximum supply.
3	GND	Ground: Internally connected to tab (ground).
4	OUT	Regulated Output
5	ADJ	Output Voltage Adjust: 1.240V feedback from external resistive divider.

## Absolute Maximum Ratings

Input Supply Voltage (Note 1) ..... -20V to +20V  
 Power Dissipation ..... Internally Limited  
 Storage Temperature Range ..... -65°C to +150°C  
 Lead Temperature (Soldering, 5 sec.) ..... 260°C

## Operating Ratings

Operating Junction Temperature ..... 0°C to +125°C  
 $\theta_{JC}$  (TO-220) ..... 2°C/W  
 $\theta_{JA}$  (TO-220) ..... 55°C/W

## Electrical Characteristics

All measurements at  $T_J = 25^\circ\text{C}$  unless otherwise noted. **Bold** values are guaranteed across the operating temperature range.

Parameter	Condition	Min	Typ	Max	Units
Output Voltage	$10\text{mA} \leq I_O \leq I_{FL}$ , $(V_{OUT} + 1\text{V}) \leq V_{IN} \leq 8\text{V}$ (Note 2)	<b>-2</b>		<b>2</b>	%
Line Regulation	$I_O = 10\text{mA}$ , $(V_{OUT} + 1\text{V}) \leq V_{IN} \leq 8\text{V}$		0.06	0.5	%
Load Regulation	$V_{IN} = V_{OUT} + 1\text{V}$ , $10\text{mA} \leq I_{OUT} \leq I_{FULL\ LOAD}$ (Notes 2, 6)		0.2	1	%
$\Delta V_O / \Delta T$	Output Voltage Temperature Coefficient (Note 6)		<b>20</b>	<b>100</b>	ppm/ $^\circ\text{C}$
Dropout Voltage	$\Delta V_{OUT} = -1\%$ , (Note 3) MIC29510/29512 $I_O = 100\text{mA}$ $I_O = 750\text{mA}$ $I_O = 1.5\text{A}$ $I_O = 3\text{A}$ $I_O = 5\text{A}$		80	<b>200</b>	mV
			200		mV
			320	mV	
			500	mV	
			700	<b>1000</b>	mV
Ground Current	MIC29510/29512 $I_O = 750\text{mA}$ , $V_{IN} = V_{OUT} + 1\text{V}$ $I_O = 1.5\text{A}$ $I_O = 3\text{A}$ $I_O = 5\text{A}$		3	<b>20</b>	mA
			10		mA
			36		mA
			100	<b>150</b>	mA
$I_{GNDDO}$ Ground Pin Current at Dropout	$V_{IN} = 0.5\text{V}$ less than specified $V_{OUT}$ . $I_{OUT} = 10\text{mA}$		2	3	mA
Current Limit	MIC29510/29512 $V_{OUT} = 0\text{V}$ (Note 4)	5.0	6.5		A
$e_n$ , Output Noise Voltage (10Hz to 100kHz) $I_L = 100\text{mA}$	$C_L = 47\mu\text{F}$		260		$\mu\text{V}_{RMS}$

### Reference (MIC29512 only)

Reference Voltage	$10\text{mA} \leq I_O \leq I_{FL}$ , $V_{OUT} + 1\text{V} \leq V_{IN} \leq 8\text{V}$ (Note 2)	<b>1.215</b>		<b>1.265</b>	$V_{MAX}$
Adjust Pin Bias Current			40	80 <b>120</b>	nA nA
Reference Voltage Temperature Coefficient	(Note 7)		20		ppm/ $^\circ\text{C}$
Adjust Pin Bias Current Temperature Coefficient			0.1		nA/ $^\circ\text{C}$

Parameter	Conditions	Min	Typical	Max	Units
<b>Enable Input (MIC29512 only)</b>					
Input Logic Voltage	Low (Off)	2.4		0.8	V
	High (On)				V
Enable (EN) Pin Input Current	$V_{EN} = V_{IN}$		15	30	$\mu A$
	$V_{EN} = 0.8V$		–	2	$\mu A$
Regulator Output Current in Shutdown	(Note 8)		10	20	$\mu A$

**General Note:** Devices are ESD sensitive. Handling precautions recommended.

**Note 1:** The maximum continuous supply voltage is 16V.

**Note 2:** Full Load current is defined as 5A for the MIC29510/29512. For testing,  $V_{OUT}$  is programmed to 5V.

**Note 3:** Dropout voltage is defined as the input-to-output differential when the output voltage drops to 99% of its nominal value with  $V_{OUT} + 1V$  applied to  $V_{IN}$ .

**Note 4:** For this test,  $V_{IN}$  is the larger of 8V or  $V_{OUT} + 3V$ .

**Note 5:** Ground pin current is the regulator quiescent current. The total current drawn from the source is the sum of the load current plus the ground pin current.

**Note 6:** Output voltage temperature coefficient is defined as the worst case voltage change divided by the total temperature range.

**Note 7:**  $V_{REF} \leq V_{OUT} \leq (V_{IN} - 1V)$ ,  $2.4V \leq V_{IN} \leq 16V$ ,  $10mA < I_L \leq I_{FL}$ ,  $T_J \leq T_{JMAX}$ .

**Note 8:**  $V_{EN} \leq 0.8V$  and  $V_{IN} \leq 8V$ ,  $V_{OUT} = 0$ .

## Block Diagram

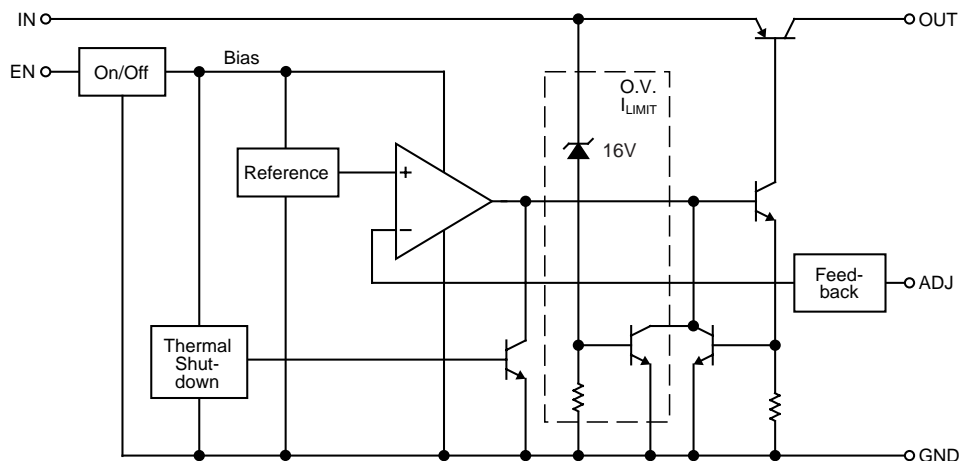

# Typical Characteristics

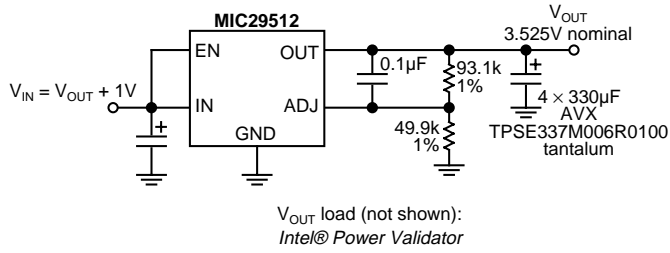

**MIC29512 Load Transient Response Test Circuit**

**MIC29512 Load Transient Response (See Test Circuit Schematic)**

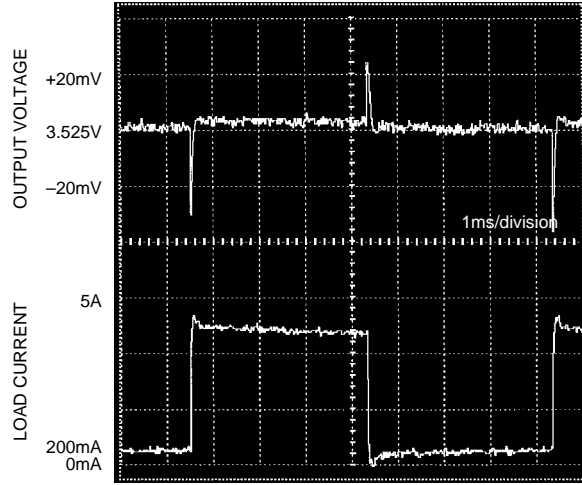

**MIC29512 Line Transient Response with 5A Load, 10µF Output Capacitance**

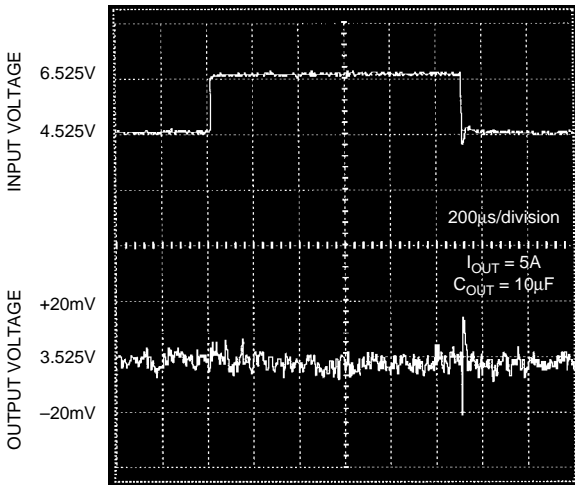

**MIC29512 Line Transient Response with 5A Load, 100µF Output Capacitance**

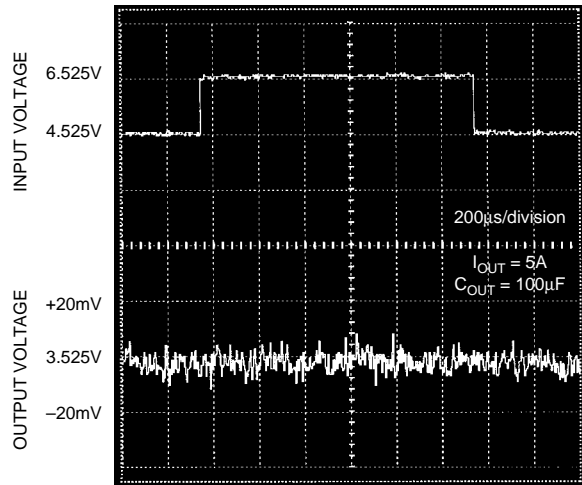

**MIC2951x Dropout Voltage vs. Output Current**

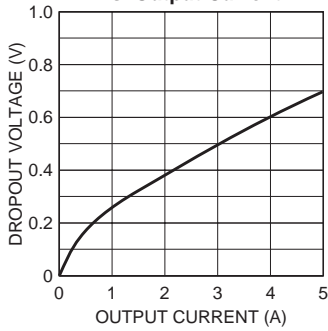

**MIC2951x Dropout Voltage vs. Temperature**

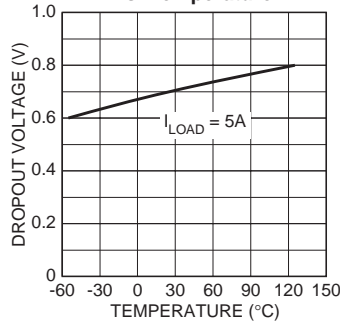

**MIC29510-3.3 Dropout Characteristics**

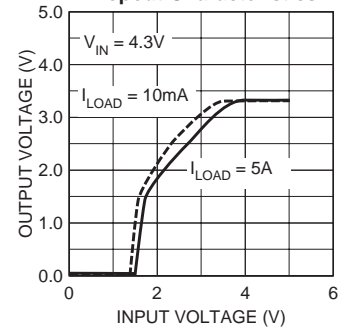

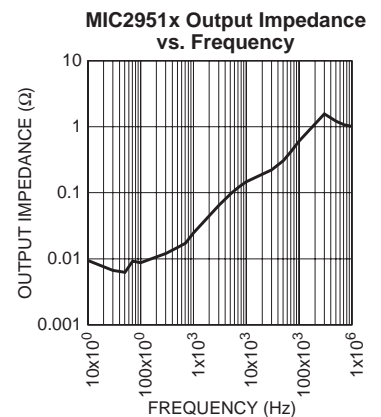
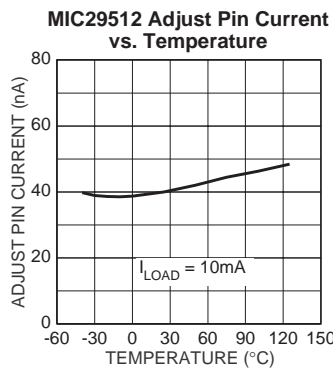
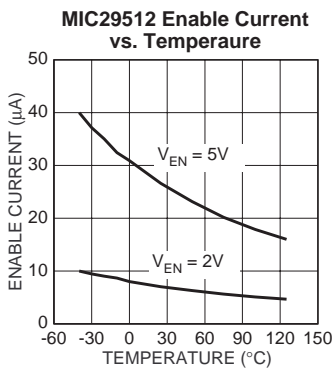
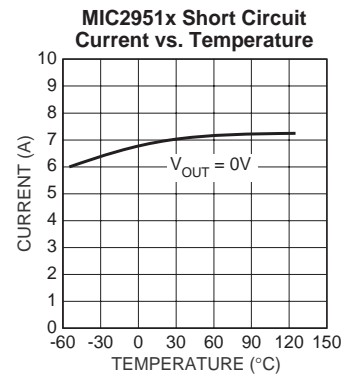
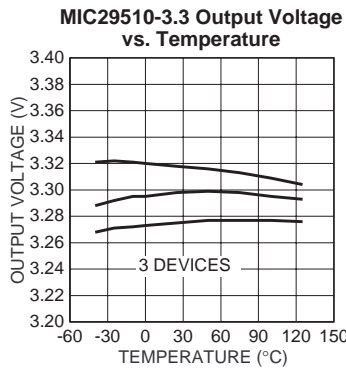
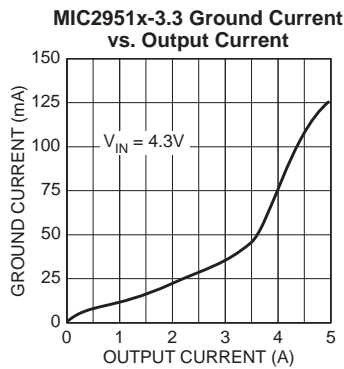
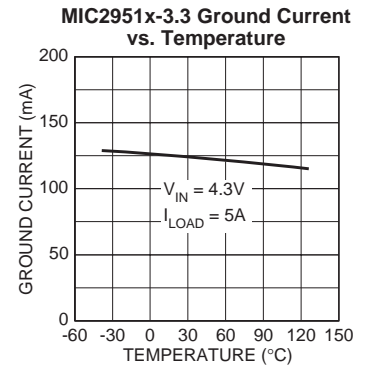
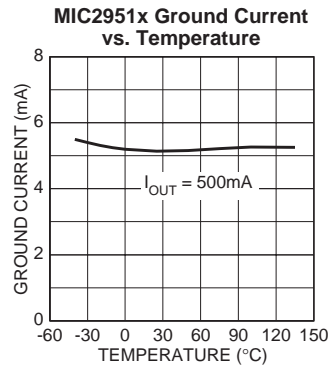
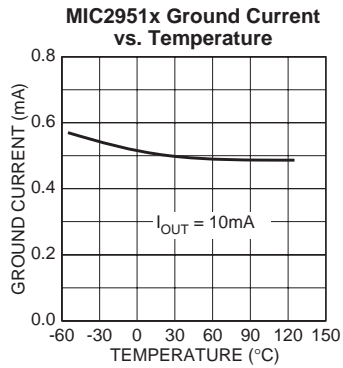
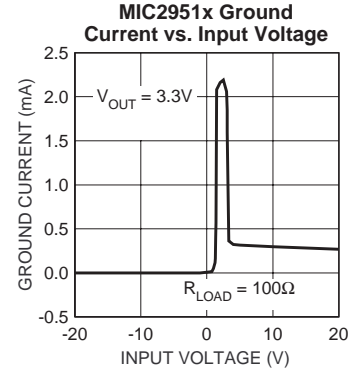
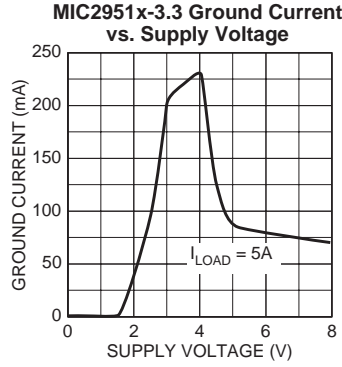
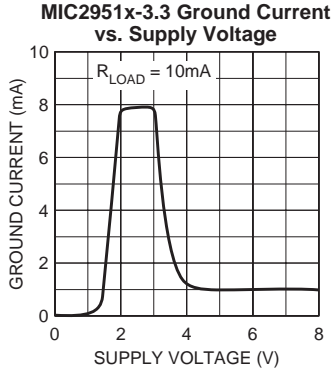

## Applications Information

The MIC29510 and MIC29512 are high performance low-dropout voltage regulators suitable for all moderate to high-current voltage regulator applications. Their 600mV of dropout voltage at full load make them especially valuable in battery powered systems and as high efficiency noise filters in “post-regulator” applications. Unlike older NPN-pass transistor designs, where the minimum dropout voltage is limited by the base-emitter voltage drop and collector-emitter saturation voltage, dropout performance of the PNP output of these devices is limited merely by the low  $V_{CE}$  saturation voltage.

A trade-off for the low dropout voltage is a varying base drive requirement. But Micrel's Super  $\beta$  PNP™ process reduces this drive requirement to merely 2 to 5% of the load current.

MIC29510/512 regulators are fully protected from damage due to fault conditions. Current limiting is provided. This limiting is linear; output current under overload conditions is constant. Thermal shutdown disables the device when the die temperature exceeds the maximum safe operating temperature. Transient protection allows device (and load) survival even when the input voltage spike above and below nominal. The output structure of these regulators allows voltages in excess of the desired output voltage to be applied without reverse current flow. The MIC29512 version offers a logic level ON/OFF control: when disabled, the devices draw nearly zero current.

An additional feature of this regulator family is a common pinout: a design's current requirement may change up or down yet use the same board layout, as all of Micrel's high-current Super  $\beta$  PNP™ regulators have identical pinouts.

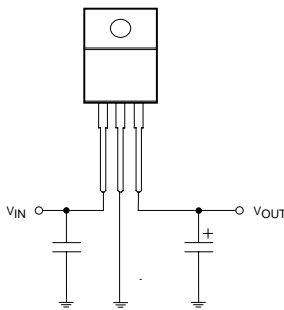

**Figure 3. The MIC29510 LDO regulator requires only two capacitors for operation.**

### Thermal Design

Linear regulators are simple to use. The most complicated design parameters to consider are thermal characteristics. Thermal design requires the following application-specific parameters:

- Maximum ambient temperature,  $T_A$
- Output Current,  $I_{OUT}$
- Output Voltage,  $V_{OUT}$
- Input Voltage,  $V_{IN}$

First, we calculate the power dissipation of the regulator from these numbers and the device parameters from this datasheet.

$$P_D = I_{OUT} \times (1.02V_{IN} - V_{OUT})$$

Where the ground current is approximated by 2% of  $I_{OUT}$ . Then the heat sink thermal resistance is determined with this formula:

$$\theta_{SA} = \frac{T_{J\ MAX} - T_A}{P_D} - (\theta_{JC} + \theta_{CS})$$

Where  $T_{J\ MAX} \leq 125^\circ\text{C}$  and  $\theta_{CS}$  is between 0 and  $2^\circ\text{C/W}$ .

The heat sink may be significantly reduced in applications where the minimum input voltage is known and is large compared with the dropout voltage. Use a series input resistor to drop excessive voltage and distribute the heat between this resistor and the regulator. The low dropout properties of Micrel Super  $\beta$  PNP regulators allow very significant reductions in regulator power dissipation and the associated heat sink without compromising performance. When this technique is employed, a capacitor of at least  $0.1\mu\text{F}$  is needed directly between the input and regulator ground.

Please refer to Application Note 9 for further details and examples on thermal design and heat sink specification.

### Capacitor Requirements

For stability and minimum output noise, a capacitor on the regulator output is necessary. The value of this capacitor is dependent upon the output current; lower currents allow smaller capacitors. MIC29510/2 regulators are stable with a minimum capacitor value of  $47\mu\text{F}$  at full load.

This capacitor need not be an expensive low ESR type: aluminum electrolytics are adequate. In fact, extremely low ESR capacitors may contribute to instability. Tantalum capacitors are recommended for systems where fast load transient response is important.

Where the regulator is powered from a source with a high AC impedance, a  $0.1\mu\text{F}$  capacitor connected between Input and GND is recommended. This capacitor should have good characteristics to above 250kHz.

### Transient Response and 5V to 3.3V Conversion

The MIC29510/2 have excellent response to variations in input voltage and load current. By virtue of their low dropout voltage, these devices do not saturate into dropout as readily as similar NPN-based designs. A 3.3V output Micrel LDO will maintain full speed and performance with an input supply as low as 4.2V, and will still provide some regulation with supplies down to 3.8V, unlike NPN devices that require 5.1V or more for good performance and become nothing more than a resistor under 4.6V of input. Micrel's PNP regulators provide superior performance in “5V to 3.3V” conversion applications than NPN regulators, especially when all tolerances are considered.

## Adjustable Regulator Design

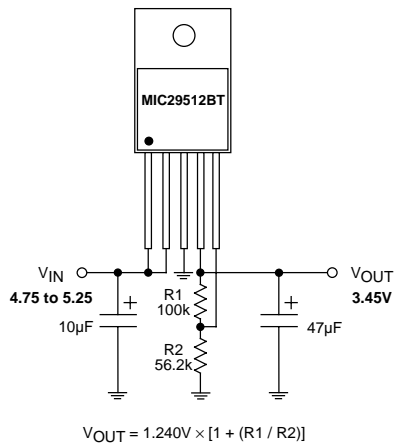

**Figure 4. Adjustable Regulator with Resistors**

The adjustable regulator version, MIC29512, allows programming the output voltage anywhere between 1.25V and

the 16V maximum operating rating of the family. Two resistors are used. Resistors can be quite large, up to 100k $\Omega$ , because of the very high input impedance and low bias current of the sense comparator. The resistor values are calculated by:

$$R1 = R2 \times \left( \frac{V_{OUT}}{1.240} - 1 \right)$$

Where  $V_O$  is the desired output voltage. Figure 4 shows component definition.

### Enable Input

The MIC29512 versions features an enable (EN) input that allows ON/OFF control of the device. Special design allows “zero” current drain when the device is disabled—only microamperes of leakage current flows. The EN input has TTL/CMOS compatible thresholds for simple interfacing with logic, or may be directly tied to  $V_{IN}$ . Enabling the regulator requires approximately 20 $\mu$ A of current into the EN pin.

## Resistor Value Table for the MIC29512 Adjustable Regulator

Voltage	Standard ( $\Omega$ )	
	R1	R2
2.85	100k	76.8k
2.9	100k	75.0k
3.0	100k	69.8k
3.1	100k	66.5k
3.15	100k	64.9k
3.3	100k	60.4k
3.45	100k	56.2k
3.6	100k	52.3k
3.8	100k	48.7k
4.0	100k	45.3k
4.1	100k	43.2k