

L131EB/5SERIES

L131EB/10SERIES

L131EB/7SERIES

### Features

- COLORS CAN BE MIXED IN A SINGLE HOUSING.
- 5,7,10 ELEMENTS.
- EASY INSTALLATION.
- SUITABLE FOR LEVEL INDICATORS.
- UL RATING : 94V-0.
- HOUSING MATERIAL: TYPE 66 NYLON.

### Description

The Bright Red source color devices are made with Gallium Phosphide Red Light Emitting Diode.

The High Efficiency Red source color devices are made with Gallium Arsenide Phosphide on Gallium Phosphide Orange Light Emitting Diode.

The Green and Super Bright Green source color devices are made with Gallium Phosphide Green Light Emitting Diode.

The Yellow source color devices are made with Gallium Arsenide Phosphide on Gallium Phosphide Yellow Light Emitting Diode.

### Package Dimensions

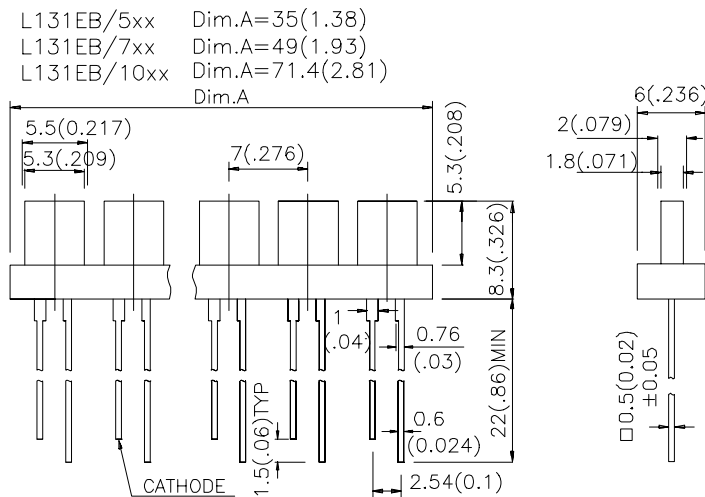

#### Notes:

1. All dimensions are in millimeters (inches).
2. Tolerance is  $\pm 0.25(0.01)$  unless otherwise noted.
3. Lead spacing is measured where the lead emerge package.
4. Specifications are subject to change without notice.

## Selection Guide

Part No.	Dice	Lens Type	Iv (mcd) @ 10 mA		Viewing Angle
			Min.	Typ.	2θ1/2
L131EB/5HD L131EB/7HD L131EB/10HD	BRIGHT RED (GaP)	RED DIFFUSED	0.3	1	110°
L131EB/5ID L131EB/7ID L131EB/10ID	HIGH EFFICIENCY RED (GaAsP/GaP)	RED DIFFUSED	2	3	110°
L131EB/5GD L131EB/7GD L131EB/10GD	GREEN (GaP)	GREEN DIFFUSED	1	1.5	110°
L131EB/5YD L131EB/7YD L131EB/10YD	YELLOW (GaAsP/GaP)	YELLOW DIFFUSED	1	1.5	110°

Note:

1. θ1/2 is the angle from optical centerline where the luminous intensity is 1/2 the optical centerline value.

## Electrical / Optical Characteristics at T<sub>A</sub>=25°C

Symbol	Parameter	Device	Typ.	Max.	Units	Test Conditions
λ <sub>peak</sub>	Peak Wavelength	Bright Red High Efficiency Red Green Yellow	700 627 565 590		nm	IF=20mA
λ <sub>D</sub>	Dominate Wavelength	Bright Red High Efficiency Red Green Yellow	660 625 568 588		nm	IF=20mA
Δλ <sub>1/2</sub>	Spectral Line Halfwidth	Bright Red High Efficiency Red Green Yellow	45 45 30 35		nm	IF=20mA
C	Capacitance	Bright Red High Efficiency Red Green Yellow	40 15 15 20		pF	VF=0V;f=1MHz
V <sub>F</sub>	Forward Voltage	Bright Red High Efficiency Red Green Yellow	2.25 2.0 2.2 2.1	2.5 2.5 2.5 2.5	V	IF=20mA
I <sub>r</sub>	Reverse Current	All		10	μA	VR = 5V

## Absolute Maximum Ratings at $T_A=25^\circ\text{C}$

Parameter	Bright Red	High Efficiency Red	Green	Yellow	Units
Power dissipation	120	105	105	105	mW
DC Forward Current	25	30	25	30	mA
Peak Forward Current [1]	120	160	140	140	mA
Reverse Voltage	5	5	5	5	V
Operation/Storage Temperature	-40°C To +85°C				
Lead Solder Temperature [2]	260°C For 5 Seconds				

**Notes:**

- 1/10 Duty Cycle, 0.1ms Pulse Width.
2. 4mm below package base.

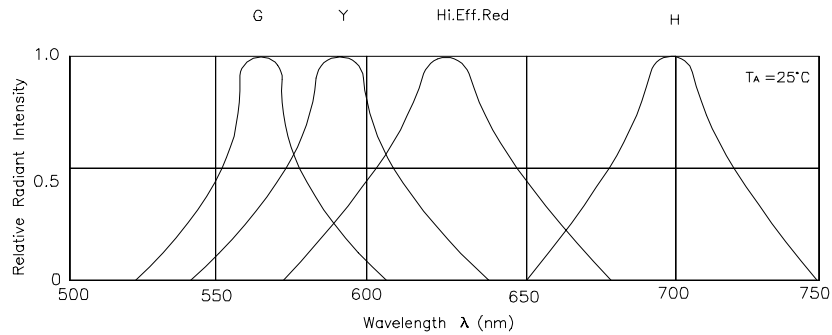

RELATIVE INTENSITY Vs. WAVELENGTH

## Bright Red

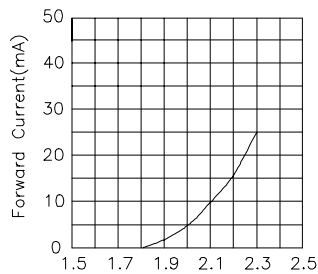

FORWARD CURRENT Vs. FORWARD VOLTAGE

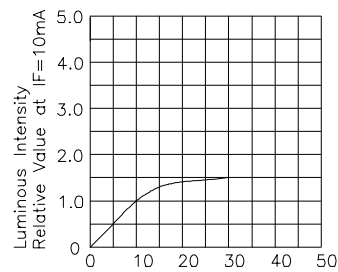

LUMINOUS INTENSITY Vs. FORWARD CURRENT

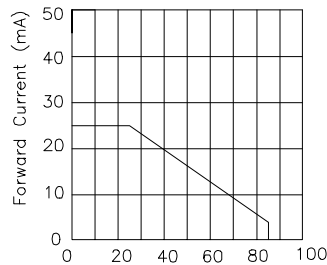

FORWARD CURRENT DERATING CURVE

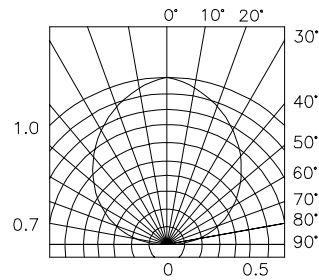

SPATIAL DISTRIBUTION

## High Efficiency Red

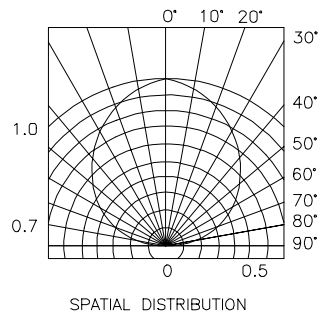
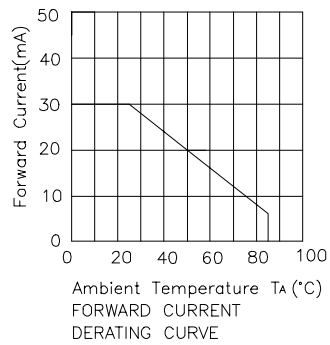
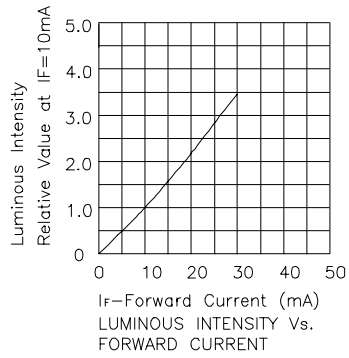
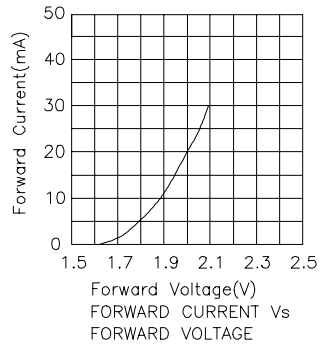

## Green

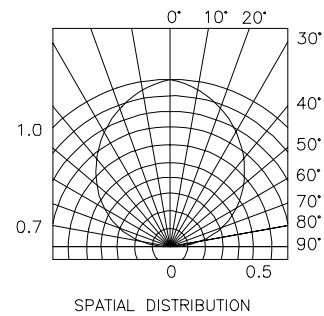
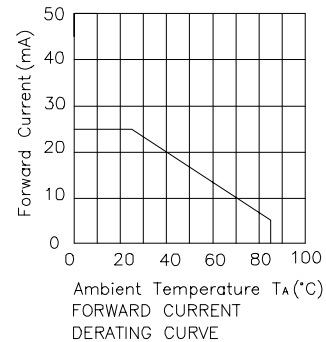
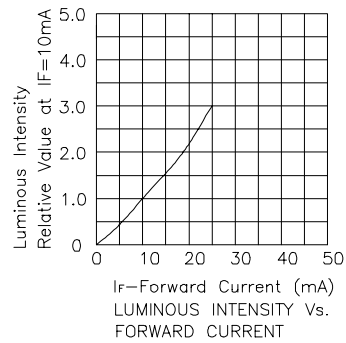
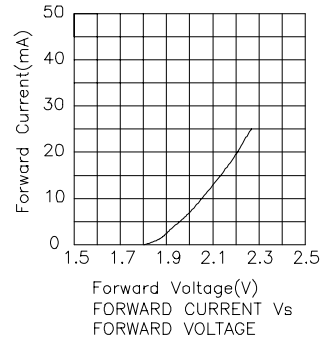

## Yellow

