

# Silicon Bipolar MMIC 5 GHz Active Double Balanced Mixer/ IF Amp

## Technical Data

### IAM-82028

#### Features

- **15 dB RF-IF Conversion Gain from 0.05 - 5 GHz**
- **IF Output from DC to 2 GHz**
- **IF Output  $P_{1dB}$  up to +12 dBm**
- **Single Polarity Bias Supply:**  
 $V_{CC} = 7$  to  $13$  V
- **Load-Insensitive Performance**
- **Conversion Gain Flat Over Temperature**
- **Low LO Power Requirements:**  
0 dBm Typical
- **Low RF to IF Feedthrough, Low LO Leakage**
- **Hermetic Ceramic Surface Mount Package**

#### Description

The IAM-82028 is a complete moderate-power double-balanced active mixer housed in a miniature ceramic hermetic surface mount package. It is designed for narrow or wide bandwidth commercial, industrial and military applications having RF inputs up to 5 GHz and IF outputs from DC to 2 GHz. Operation at RF and LO frequencies less than 50 MHz can be achieved using optional external capacitors to ground. The IAM-82028 is particularly well suited for applications that require load-insensitive conversion gain and good spurious signal suppression and moderate dynamic range with minimum LO power. Typical applications include frequency

#### 28 Package

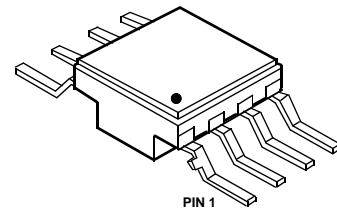

downconversion, modulation, demodulation and phase detection for fiber-optic, GPS satellite navigation, mobile radio, and communications receivers.

The IAM series of Gilbert multiplier-based frequency converters is fabricated using HP's 10 GHz  $f_T$ , 25 GHz  $f_{MAX}$  ISOSAT™-I silicon bipolar process which uses nitride self-alignment, submicrometer lithography, trench isolation, ion implantation, gold metallization and polyimide inter-metal dielectric and scratch protection to achieve excellent performance, uniformity and reliability.

#### Typical Biasing Configuration and Functional Block Diagram

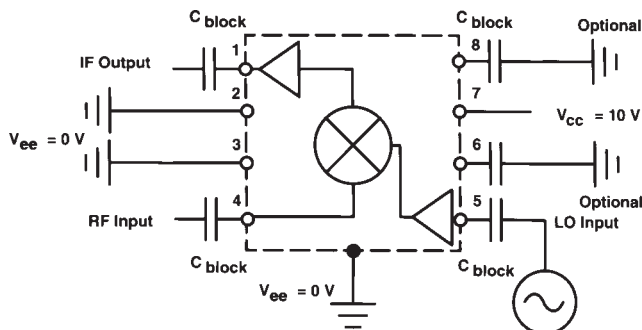

Note: No external BALUNs are required.

## Absolute Maximum Ratings

Parameter	Absolute Maximum <sup>[1]</sup>
Device Voltage	15 V
Power Dissipation <sup>[2,3]</sup>	1200 mW
RF Input Power	+14 dBm
LO Input Power	+14 dBm
Junction Temperature	200°C
Storage Temperature	-65°C to 200°C

**Thermal Resistance:**<sup>[2,4]</sup>

$$\theta_{jc} = 45^{\circ}\text{C/W}$$

**Notes:**

1. Permanent damage may occur if any of these limits are exceeded.
2.  $T_{\text{CASE}} = 25^{\circ}\text{C}$ .
3. Derate at 22.2 mW/°C for  $T_{\text{C}} > 146^{\circ}\text{C}$ .
4. See MEASUREMENTS section "Thermal Resistance" in Communications Components Catalog, for more information.

## IAM-82028 Electrical Specifications<sup>[1]</sup>, $T_{\text{A}} = 25^{\circ}\text{C}$

Symbol	Parameters and Test Conditions <sup>[2]</sup> : $V_{\text{CC}} = 10 \text{ V}$ , $V_{\text{ee}} = 0 \text{ V}$ , $V_{\text{gc}} = 0 \text{ V}$ , $Z_{\text{O}} = 50 \Omega$	Units	Min.	Typ.	Max.
$G_{\text{C}}$	Conversion Gain RF = 2 GHz, LO = 1.75 GHz	dB	13.5	15	16.5
$f_{3\text{dB}}^{\text{RF}}$	RF Bandwidth ( $G_{\text{C}}$ 3 dB Down) IF = 250 MHz	GHz		5.5	
$f_{3\text{dB}}^{\text{IF}}$	IF Bandwidth ( $G_{\text{C}}$ 3 dB Down) LO = 2 GHz	GHz		0.6	
$P_{1\text{dB}}$	IF Output Power at 1 dB Gain Compression RF = 2 GHz, LO = 1.75 GHz	dBm		8	
$IP_3$	IF Output Third Order Intercept Point RF = 2 GHz, LO = 1.75 GHz	dBm		18	
NF	SSB Noise Figure RF = 2 GHz, LO = 1.75 GHz	dB		16	
VSWR	RF Port VSWR $f = 0.05$ to 5 GHz			1.5:1	
	LO Port VSWR $f = 0.05$ to 5 GHz			2:1	
	IF Port VSWR $f < 2$ GHz			2.3:1	
$RF_{\text{if}}$	RF Feedthrough at IF Port RF = 2 GHz, LO = 1.75 GHz	dBc		-30	
$LO_{\text{if}}$	LO Leakage at IF Port LO = 1.75 GHz	dBm		-20	
$LO_{\text{rf}}$	LO Leakage at RF Port LO = 1.75 GHz	dBm		-30	
$I_{\text{CC}}$	Supply Current	mA	40	55	65

**Note:**

1. The recommended operating voltage range for this device is 7 to 13 V. Typical performance as a function of voltage is on the following page.

**Typical Performance,  $T_A = 25^\circ\text{C}$ ,  $V_{CC} = 10\text{ V}$**   
**RF: -20 dBm at 2 GHz, LO: 0 dBm at 1.75 GHz**  
(unless otherwise noted)

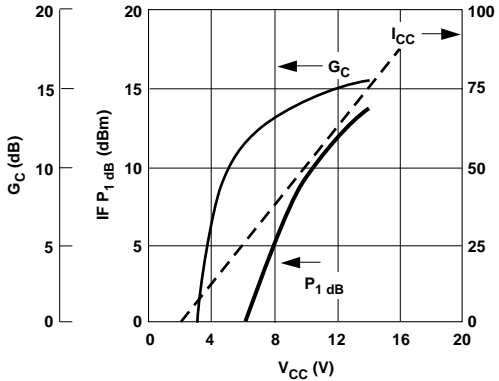

**Figure 1. Conversion Gain, IF  $P_1$  dB and  $I_{CC}$  Current vs.  $V_{CC}$  Bias Voltage.**

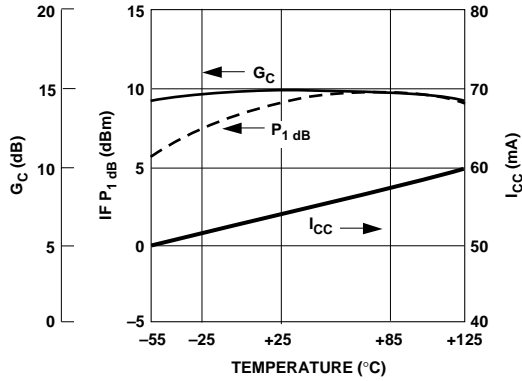

**Figure 2. Conversion Gain, IF  $P_1$  dB and  $I_{CC}$  Current vs. Case Temperature.**

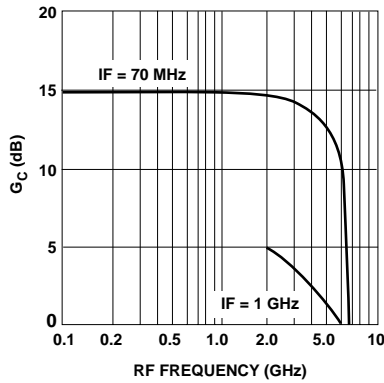

**Figure 3. Typical RF to IF Conversion Gain vs. RF Frequency,  $T_A = 25^\circ\text{C}$  (Low Side LO).**

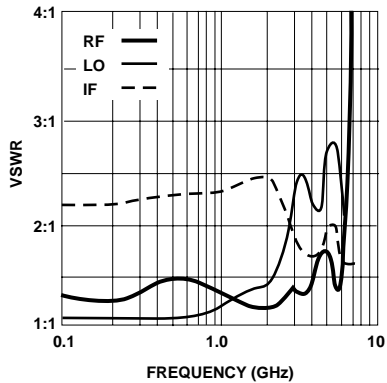

**Figure 4. RF, LO and IF Port VSWR vs. Frequency.**

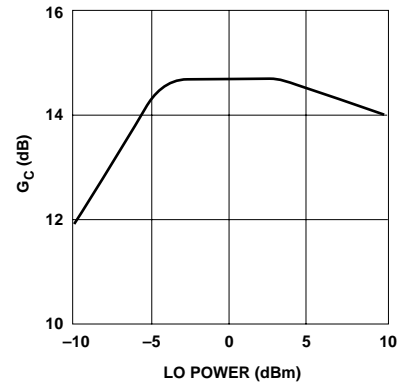

**Figure 5. RF to IF Conversion Gain vs. LO Power.**

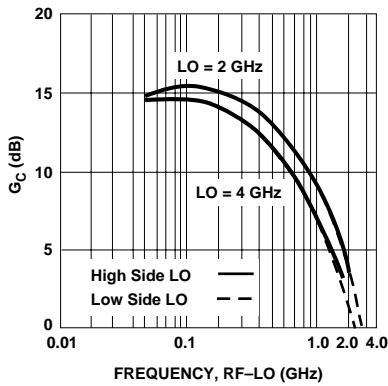

**Figure 6. RF to IF Conversion Gain vs. IF Frequency.**

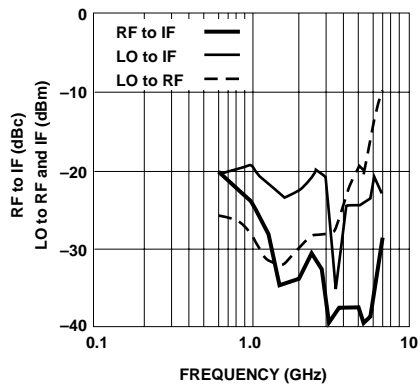

**Figure 7. RF Feedthrough Relative to IF Carrier, dBm LO to RF and IF Leakage vs. Frequency.**

0	—	23	40	>75	>75	>75
1	12	0	52	60	>75	>75
2	6	35	43	>75	>75	>75
3	27	18	59	74	>75	>75
4	22	38	52	>75	>75	>75
5	41	36	73	74	>75	>75
	0	1	2	3	4	5

HARMONIC LO ORDER  
HARMONIC RF ORDER  
 $X_{mn} = P_{if} - P(m \cdot rf - n \cdot lo)$

**Figure 8. Harmonic Intermodulation Suppression (dB Below Desired Output) RF at 1 GHz, LO at 0.752 GHz, IF at 0.248 GHz.**

# Package Dimensions

## 28Package

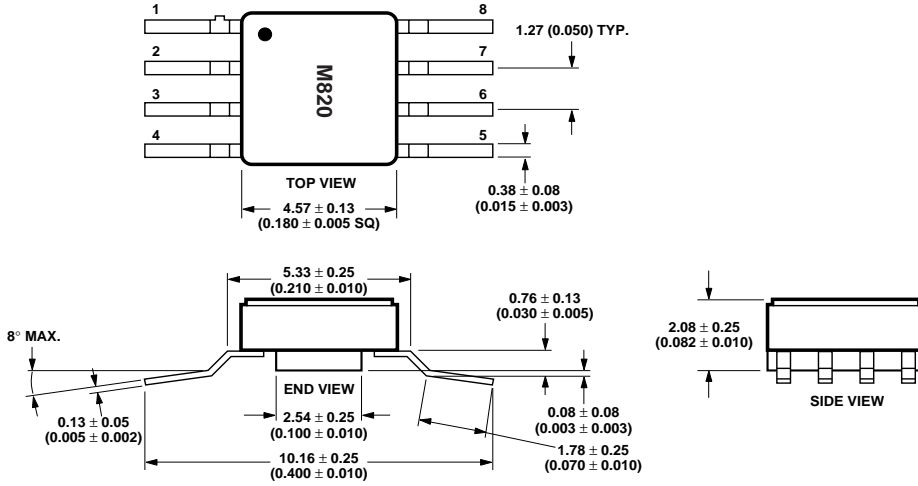

DIMENSIONS ARE IN MILLIMETERS (INCHES)